

3D PRINTING HANDBOOK

USER MANUAL FOR 3D PRINTERS:

- ORIGINAL PRUSA SL1 KIT
- ORIGINAL PRUSA SL1



PRUSA
RESEARCH
by JOSEF PRUSA

 ENG

ORIGINAL INSTRUCTIONS

Original Instructions: Basic info

To download the handbook in other languages, such as **Deutsch, Français, Italiano, Español, Čeština and Polski**, visit prusa.io/sl1s or scan the QR code on the right. This link will also take you to a hub that contains the latest downloads (firmware, handbook, drivers, PrusaSlicer) and also relevant help articles.

Handbook version 1.08 from January 2nd, 2024



prusa.io/sl1s

QUICK GUIDE TO YOUR FIRST PRINT

1. Read the safety instructions carefully
2. Place the printer on a flat and stable surface
3. Download and install updated firmware and software packages
4. **Calibrate the printer** by following the on-screen calibration flow / wizard
5. Inspect the FEP film (bottom of the tank) for any kind of damage
6. Pour resin into the tank
7. Use the Print menu file browser to select a sample object to print



Important notice, tip, hint or information that helps you print with ease.



Read carefully! This part of the text has the greatest importance - either for user safety or for proper printer service.

JOSEF PRUSA®, PRUSA RESEARCH®, PRUSA POLYMERS®, PRUSA ORANGE®, ORIGINAL PRUSA®, PRUSA 3D®, and PRUSAMENT® are registered trademarks of Prusa Development a.s. used by Prusa Research a.s. under license from Prusa Development a.s. | JOSEF PRUSA, ORIGINAL PRUSA, and PRUSAMENT are registered trademarks (or trademark applications) of Prusa Development a.s. and are used by Prusa Research a.s. under license from Prusa Development a.s. in the following countries: Australia, New Zealand, Israel, Mexico, South Korea, Turkey, Ukraine, Russia, Kazakhstan, Switzerland, China, Colombia, Uzbekistan, Philippines and Norway. | All other company names and product names mentioned in this publication are trademarks and registered trademarks of their respective companies.

Handbook version 1.08 from January 2nd, 2024 © Prusa Research a.s.

About the author

Josef Prusa (born Feb 23rd, 1990) became interested in the 3D printing phenomenon before joining Prague's University of Economics in 2009 - at first, it was a hobby, a new technology open to changes and improvements. The hobby soon became a passion and Josef grew into one of the leading developers of Adrien Bowyer's international, open-source, RepRap project. Today, you can see the Prusa design in different versions all around the world, it is one of the most popular printers and thanks to it, knowledge about the 3D printing technology significantly increased among the public.

Jo's work on self-replicating printers (you can print the other printer parts with your printer) is still ongoing and the latest model, Prusa i3 MK3S, is currently on the market - it's an improved version of the original 3D printer's third iteration. Prusa Research keeps expanding into new territories and the original Prusa SL1S you just purchased is just one of the examples.

Josef Prusa also organizes workshops for the public, and participates in professional conferences dedicated to the popularization of 3D printing. For example, he lectured at the TEDx conference in Prague and Vienna, at World Maker Faire in New York, Maker Faire in Rome and at the Open Hardware Summit hosted by MIT. Josef also teaches Arduino at Charles University and was also a lecturer at the Academy of Arts in Prague.

In his own words, he imagines 3D printers will be available in every home in the not-too-distant future. "If anything is needed, you can simply print it. In this field, you just push the boundaries every day... We're glad you're part of it with us!"



Josef Prusa

Table of contents

1. Introduction	9
2. Glossary	10
2.1. Accessories - bundled and optional	11
3. Quick-start information	12
3.1. How to contact tech support and send log files	13
4. Your First Print	15
4.1. Unpacking	15
4.2. First start and Calibration	15
4.3. Navigating the menus	19
4.4. Updating the printer's firmware	20
4.5. Network connection - recommended	20
4.5.1. Internet connection - Ethernet cable	20
4.5.2. Internet connection - Wireless connection	20
4.6. Time and time zone configuration (optional)	21
4.7. Pouring resin into the tank	21
4.8. Running out of resin / Adding resin mid-print	22
4.9. Starting the First print	23
4.10. Removing the print	24
4.11. Removing a print stuck to the bottom of the tank	25
4.12. Removing supports	25
4.13. Bundled 3D models	26
5. After-print checks and actions	27
5.1. Washing / Curing / Drying models	27
5.1.1. Washing	27
5.1.2. Drying and curing	28
5.2. Disposing of resins	28
5.3. Menu structure and advanced functions	29
6. Printing your own models	30
6.1. Obtaining a printable model	30
6.2. Creating your own models	32
6.3. What are SL1S files?	32
6.4. PrusaSlicer	33
6.5. Slicing objects for the SL1S	34
6.6. Importing an object into PrusaSlicer	35
6.7. Positioning an object	36
6.8. How to generate supports for SLA prints	36
6.9. Pad, supports, layer height and exposure times	38
6.9.1. Pad	39
6.9.2. Supports	39
6.9.3. Layer height explained	39
6.9.4. Exposure time explained	40
6.10. Slicing, exporting and printing custom models	41
6.11. Object orientation and slicing examples	42
6.11.1. Reims Cathedral	42
6.11.2. Petrin tower	42
6.11.3. Jewelry	43
6.11.4. Characters and props	43
6.12. How to recognize problematic areas	44
6.13. Printing large and heavy objects	45

6.14. Hollowing objects in PrusaSlicer	45
7. Connecting PrusaSlicer to the SL1S over the network	48
8. Updating the printer's firmware	50
9. About resins	50
9.1. Important information about resins	51
9.2. Which resins to buy?	52
9.3. Custom resin calibration	52
10. Software/driver package	53
11. Controlling the printer via a web browser	53
12. Optional Accessories	54
12.1. Original Prusa Curing and Washing Machine - CW1S	54
12.2. FEP Films - Original and Aftermarket	54
12.3. Additional accessories	56
13. Regular Printer Maintenance	56
13.1. Keeping the printer clean	56
13.2. FEP film / Tank maintenance	57
13.3. Tank and FEP film cleaning	57
13.4. Print platform maintenance	58
13.5. Exposure screen maintenance	58
13.6. Acrylic lid	58
13.7. UV light and potential health risks	59
13.8. Fan cleaning / Removing dust	59
13.9. Carbon filter replacement	60
13.10. Tower maintenance	60
13.11. Tilt maintenance	60
14. Hardware troubleshooting	61
14.1. FEP film / Tank bottom replacement	61
14.2. Replacing the print screen	61
14.3. Spilled resin	62
15. Print quality troubleshooting	62
15.1. Removing an object stuck to the bottom of the tank	62
15.2. First layer doesn't stick (Non-Adherence)	63
15.3. Printed object has missing parts	64
15.4. Printed object is missing small details	65
15.5. Printed object detached from supports	65
15.6. Broken supports	66
15.7. Printed object is skewed / deformed	67
15.8. Print doesn't appear / resin does not solidify	67
15.9. Printed object has very visible layers	67
15.10. Delamination / Separated layers	68
15.11. Warped layers	69
15.12. Large holes in printed objects	69
16. FAQ - Frequently Asked Questions	71

About this handbook

This handbook is designed to help you start printing with the Original Prusa SL1S as fast as possible. It's divided into several main parts - **pay close attention to chapters about correct usage, health risks, calibration and first print.**

Product details

- Title: Original Prusa SL1S SPEED
- Manufacturer: Prusa Research a.s., Partyzánská 188/7A, Prague, 170 00, Czech Republic
- Contact e-mail: info@prusa3d.com
- EEE group: 3 (IT and/or telecommunication equipment)
- Device use: indoor only
- Power supply: 100-240 VAC, 1.8 A (50-60 Hz)
- Working temperature range: 18 °C - 32 °C, indoor use only
- Working humidity: 85 % or less
- Compatible resins: 405nm wavelength

Declaration of conformity can be downloaded from <http://www.prusa3d.com>

Assembled printer weight (gross / net): 14.7 kg / 10.6 kg. The serial number is located on the back of the printer, in the printer's support menu and also on the packaging.

Original Prusa SL1S is equipped with a wireless network card. This wireless module complies with IEEE 802.11 b/g/n standard and it can achieve a speed of up to 72.2Mbps with single stream in 802.11n draft, 54Mbps as specified in IEEE 802.11g, or 11Mbps for IEEE 802.11b to connect to the wireless LAN. The integrated module provides SDIO interface for Wi-Fi.



Licenses

The Original Prusa SL1S is published under a GNU GPL v3 license (www.gnu.org/licenses/gpl-3.0.en.html). If you improve, or alter any part of, the printer, and you want to sell them, then you have to publish the source code under the same license. Source codes can be found at <https://www.github.com/prusa3d>

Warranty

The pre-assembled Original Prusa SL1S printer is covered by a **24-month warranty for end customers in the EU and 12 months for businesses and non-EU customers.**

The warranty period begins with the day when the customer receives the goods. **WARNING: The exposure display and the FEP foil fall into the category of normal wear and tear components**, which are not covered by our standard warranty. The lifespan of the exposure display is a maximum of **2000 hours of printing** - the SLA 3D printing process on the Original Prusa SL1S is considered the standard way of using and wearing the original display.

The lifespan of the FEP foil is 10 cycles. When used properly in accordance to the instructions in the official guides (such as this handbook), the life expectancy of the FEP foil can be several times longer.

Neither the Seller's liability for defective products nor the quality warranty apply to printers or parts damaged by handling, which is in conflict with the instructions and recommendations in the official manuals and guides, or improper handling caused by unofficial modifications, such as modifications to hardware or software.

Safety instructions

Please be very cautious during any interaction with the printer. This printer is an electrical device with moving parts and UV light emission.

1. The device is for indoor use only. Do not expose the printer to rain or snow. Always keep the printer in a dry environment at a minimum distance of 30 cm from other objects. Make sure none of the vents/fan outlets are blocked.
2. Always place the printer on a stable place, where it cannot fall or tip over.
3. The printer supply is household power outlet 230 VAC, 50 Hz or 110 VAC / 60 Hz. Never connect the printer to a different power supply; it may cause malfunction or damage to the printer.
4. Place the power cord so you cannot stumble over it, step on it, or otherwise expose it to any potential damage. Also make sure that the power cord is not mechanically or otherwise damaged. If so, stop using the damaged power cord immediately and replace it.
5. When you disconnect the power cord from the socket, pull the plug rather than the cord to reduce the risk of damage to the plug or to the AC outlet.
6. Never disassemble the printer's power supply; it does not contain any parts that could be repaired by an unskilled worker. All repairs must be performed by a qualified technician.
7. Do not reach inside the printer while it is still in operation. An injury may be caused by its moving parts or electrical current.
8. Prevent children from unsupervised access to the printer even when the printer is not printing.
9. Do not leave the printer unattended while it's still on!
10. Do not print with a disassembled printer or with a printer that has an open lid or any parts missing.
11. Never look directly into the UV light.
12. Keep in mind that resins are liquids that produce odors. Make sure the printer is set in a ventilated place. Protect the machine from drops of liquid.
13. Some people may be allergic to resins - either to skin contact or even the vapors. If you experience any kind of discomfort when working with resins (like itching), stop immediately and consult your doctor

1. Introduction

Thank you for purchasing the Original Prusa SL1S SPEED printer! Your purchase supports us in the further development of our products. Please, read this handbook carefully, since all chapters contain valuable information regarding **the use, maintenance, and troubleshooting of the SL1S printer**.

The Original Prusa SL1 was our first foray into the world of SLA printers. We wanted to build a solid, sturdy and robust 3D printer that would produce consistent, high-quality 3D prints. Based on the general feedback and reviews, we did many things right. The SL1 found its way not just into hobbyists' workshops but into various industries as well. As usual, we started collecting feedback and thinking about improving the machine even further – one of the areas we wanted to focus on was its print speed. We replaced the RGB display with a **brand new high-resolution monochrome LCD**, implemented **four times more powerful UV LED array**, increased the size of the **print area by 25 %** and added many other changes. We hope you will enjoy using the SL1S SPEED!

You can find more information about the SL1S and other printers on our official website <https://www.prusa3d.com> or on **our community hub** <https://www.printables.com>, where you can download models for printing, chat with other users or create local printing communities!

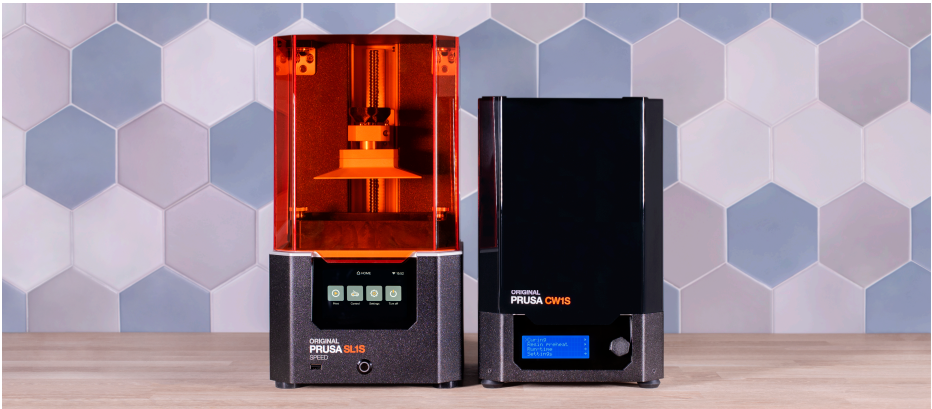

How does SLA 3D printing work?



The **Original Prusa SL1S SPEED** is an SLA, or more specifically, an **MSLA 3D printer**. SLA stands for Stereolithography Apparatus and the “M” at the beginning means “Masked”. SLA printers use UV light to cure (solidify) photosensitive liquid resins. The SL1S has a built-in high-resolution monochrome LCD screen which displays a mask in the shape of a single layer. Then, the UV LED panel shines UV light through the mask into the resin tank with a transparent bottom. UV light cures (solidifies) a single layer of the printed object, which adheres to the print platform. After a layer is cured, the print platform moves by a small increment upwards, creating space for another layer. SLA is thus an additive printing method

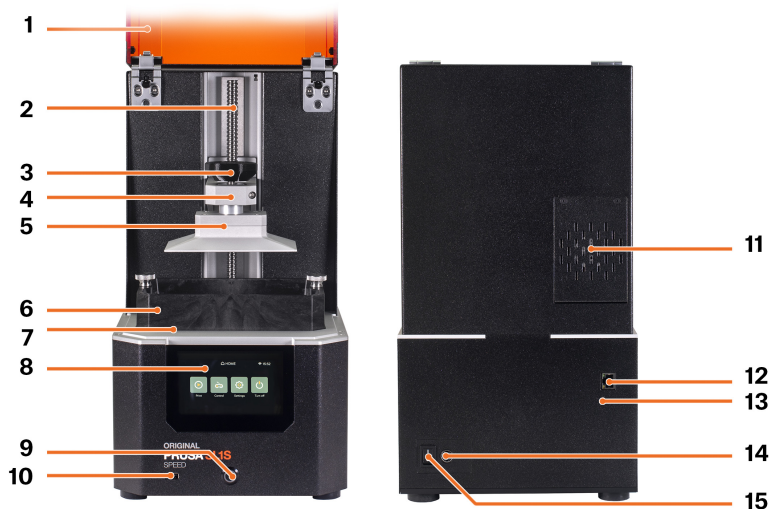

2. Glossary

1. **Lid** - The orange-colored lid is made of acrylic and its layers protect the liquid resin from UV light (such as sunlight), which would otherwise cure it. Still, it's not a 100% shield and the printer should not be placed in direct sunlight. The lid must be closed during printing.
2. **Tower / Z-Axis** - The mechanism that raises and lowers the cantilever with the print platform. The cantilever is secured with a ball screw.
3. **Knob** - Large black knob at the top of the cantilever is designed for easy mounting/dismounting of the print platform.
4. **Cantilever** - Holds the print platform and travels along the Z-Axis
5. **Print platform** - Print platform is made of a single-block of aluminum and it is connected via a cantilever to the motorized tower. The large flat part is the area where the printed object appears. The print platform can be easily removed by loosening the Knob without affecting the calibration
6. **Tank** - The container for liquid resin. It has a transparent bottom that allows UV light to pass through. The bottom of the tank is an FEP film, a consumable that will degrade after some time. The FEP film is replaceable (see chapter on Printer Maintenance). Use only warm water and dishwashing soap to clean the FEP, alternatively, you can use IPA.
7. **Tilt** - The general name for the entire bed with the motorized tilt function. The tilting platform is one of the biggest advantages of this machine. Thanks to this solution, lesser forces are required to pull the object from the bottom of the tank, which results in better-looking models and more reliable printing.
8. **Touchscreen Display / Touch screen** - The main control interface of the SL1S. The capacitive touchscreen is used to navigate through the menus, start prints, adjust settings, or calibrate the printer.
9. **Power Button** - Turns the printer on or off. This button won't disconnect the power supply. To cut off power completely, always disconnect the power cord from the back of the printer.

10. **USB port** - Used for reading SL1S print files from a USB drive
11. **Rear fan with activated carbon filter** - helps to filter out odors produced by resins. You can attach a hose to this fan using a freely downloadable adapter and lead the hose, e.g., out of the window.
12. **Ethernet port** - Can be used to connect the printer to the local network. It is located on the back of the device.
13. **Service microUSB port** - for tech support purposes only
14. **Power supply unit inlet** - use this port to connect the power supply unit.
15. **Main power switch**

2.1. Accessories - bundled and optional

There are a number of accessories and tools you will find in the package. They will help you to use the printer more effectively and safely.

- **Gloves** - for safer handling of resins
- **Sharp pliers** - for support removal
- **Funnel with a filter** - for filtering resin
- **Plastic spatula** - the only spatula you can use to carefully clean the FEP film
- **Metal spatula** - for removing objects from the print platform only
- **Allen and torx keys** - for maintenance
- **Orange resin** - 0.5l bottle
- **FEP film** - spare FEP films
- **USB Drive** - for storing print files
- **Syringe** - for managing minor resins spills / removing resin from the tank



Optional accessories you should consider buying:

- **Paper towels** - for cleaning up the printer, drying printed models...
- **Isopropyl alcohol** - for cleaning the prints
- **Plastic tablecloth** - to contain resin spillage and to make cleaning up easier
- **Respirator / protective glasses**

3. Quick-start information

The SL1S requires **maintenance and regular care**. It doesn't take a lot of time and it's not complicated, however, there are several parts in the 3D printer that can be potentially damaged as a result of incorrect use. Please keep that in mind - **failure to follow the instructions in this manual may lead to severe damage to your printer and/or to a loss of warranty**. Here is a quick run-down of things you should and shouldn't do with your Original Prusa SL1S.

SL1S 3D printer



Place in a **well-ventilated room** with ambient temperatures between 18-32°C
Connect to the internet and download **the latest firmware updates**
Calibrate the printer before the first use
Keep clean at all times

Do not place the printer in direct sunlight
Do not keep the lid open while printing

Resin tank



Empty and clean the tank after every print because tiny bits of cured resin might remain in the tank
Clean **only with warm water** and a bit of dishwashing soap or regular soap
Replace the FEP film with a new one in case it's damaged

Do not clean the FEP foil with aggressive chemicals. Use dish soap or IPA.
Do not use sharp objects to remove prints (e.g. metal spatula)
Do not print with damaged (punctured) FEP foil
Do not pour more than the recommended amount of resin (max 200 ml)

Print display and UV LED panel



Use a **soft paper towel** or cloth and an LCD screen cleaning spray to clean the protective glass
You can **test the LCD** from the Advanced Settings Menu ('Display Test' option)

Do not look directly in UV light, use a camera to check the UV panel! You can also place a sheet of paper onto the screen.
Do not leave spilled resin on the print screen
Do not use sharp objects to clean the screen

Resins



Wear gloves when handling resins, also consider wearing a simple respirator and protective goggles
Store **at room temperature in opaque bottles**, away from kids or animals

Treat as **dangerous liquids**
Follow your country's laws for disposing of dangerous liquids

Avoid skin contact

Do not drink

Do not mix different resins

Do not mix used and unused resins

Do not flush resins down the drain / into sewage

Do not leave spilled resin anywhere - clean it immediately

3.1. How to contact tech support and send log files

If you encounter an issue with your SL1S 3D printer, please check the last pages of this handbook for **general troubleshooting guides**. A more comprehensive set of troubleshooting articles is available at <https://help.prusa3d.com>. However, in case the suggested solutions don't work, please contact our tech support via e-mail at support@prusa3d.com or via the Live chat at <https://www.prusa3d.com> - the chat is in the lower right corner. Please try to attach a log file if possible. To save a log file, please follow these steps:

1. Insert a **FAT32-formatted USB flash drive** into the printer
2. Navigate to **Main Menu - Settings - System Logs - Save to USB Drive**
3. Wait until the logs are written on the USB drive. Once the procedure is finished, the printer will return to the Advanced Settings menu
4. Remove the USB drive, plug it into your PC and look for the saved log file (.txt.gz). Send this file along with your description of the issue to our tech support
5. Alternatively, you can use the **"Upload to Server" option** if your SL1S is connected to the internet. The printer will upload the log to our secure server and generate a unique code. Contact our tech support - we can then use the code to locate the log on our servers and analyze the issue.

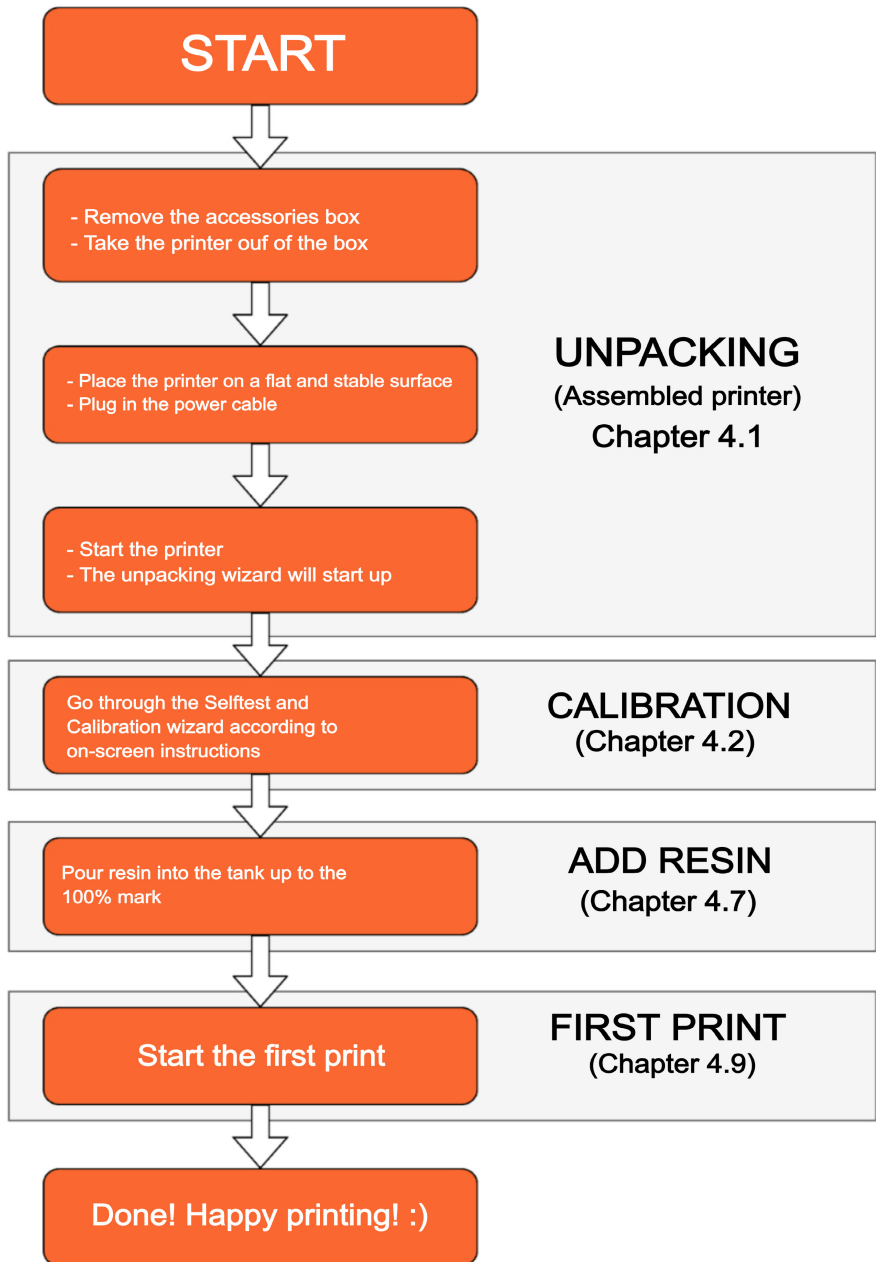

4. Your First Print

We know that you are eager to start printing immediately, however, there are a couple of steps users need to take before they can start printing. Read these chapters carefully.

4.1. Unpacking

After you open the box, remove the accessories case first (1), then remove the top foam (2). Grab the box using the two handles on the side and pull it up (3). Open the cardboard locks (4) and remove the protective wrap (5). Finally, take the unpacked SL1S and place it on a stable surface (6). **This is all for now! Do not open the orange lid yet!**

If the printer was kept in a low-temperature environment for an extended period of time, **let it warm up at ambient room temperature** for at least one hour before you start it. Otherwise, you may get errors related to low temperatures.

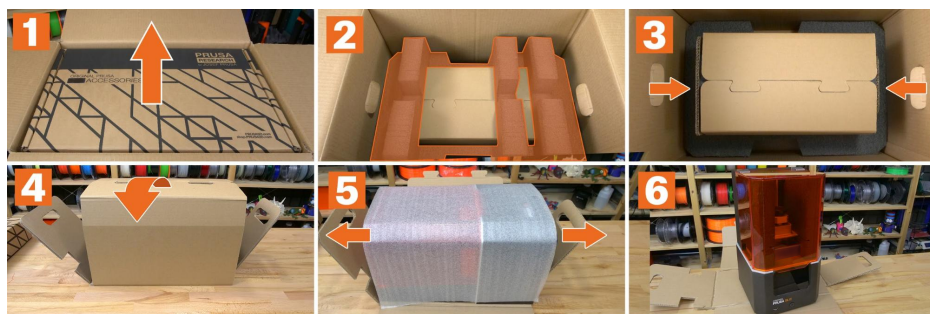

Start the printer and run the initial wizard. Continue in chapter **4.2 First start and calibration**.

4.2. First start and Calibration



The calibration is essential for correct operation

Without a properly calibrated tilt and print platform, the printed object won't stick to the platform, or even worse - you may damage your printer.

Connect the power cord and turn on the printer using the **switch on the back of the machine**, located directly next to the power plug. Then push the **round power button** on the front side. The start of the booting sequence is signaled by a slow-flashing light around the power button. After a few seconds the display will show the Prusa Research logo and then the **Wizard** appears. Use the touchscreen to navigate through the wizard. **Take your time, read all instructions carefully** and remember you scan **swipe left/right** to reveal more information about the current step.

Each described step has to be confirmed by pressing the on-screen Continue button!

The first is the **Unpacking Wizard**, which will help you to remove the remaining parts of the packaging:



1. Peel off the sticker on the right side of the printer and open the lid
2. Remove the foam protectors
3. Remove the tank and the foam layer underneath it
4. Carefully peel off the sticker from the display

Once the 3D printer is fully unpacked, the **Selftest** starts. This procedure will make sure your printer arrived in a good shape:

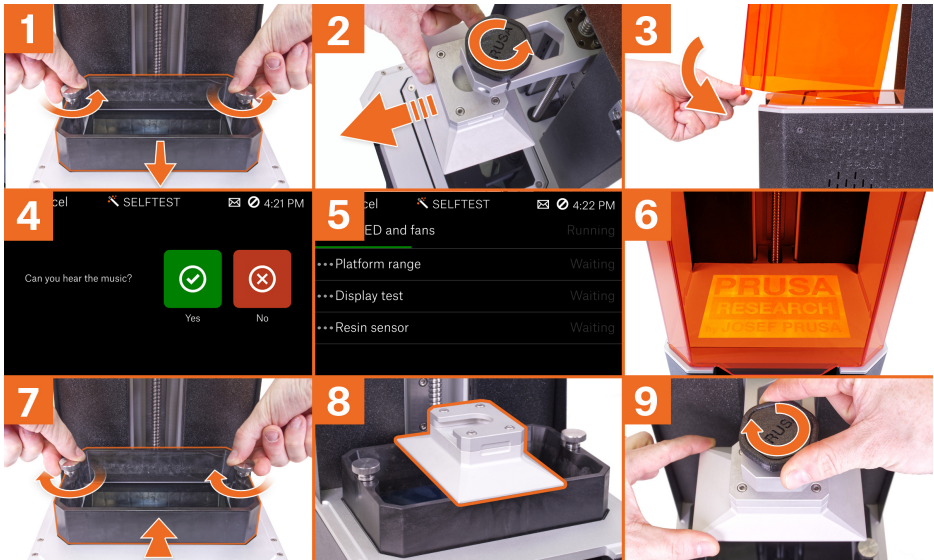

1. Remove the resin tank
2. Remove the print platform
3. Close the orange lid
4. Confirm that you hear the music
5. Wait until the check is finished
6. Take a look at the display THROUGH the orange lid. Can you see the company logo on the exposure display? You can place a sheet of paper onto the screen to make the logo more visible. Do not forget to close the cover!
7. Insert the tank and secure it with two tank screws
8. Take the print platform and place it across the tank as seen in the picture. Close the cover and wait until the cantilever touches the print platform.
9. Finally, make sure the tank is correctly secured. Place the platform on the cantilever and secure it with the black knob. The printer will make the final check and the Selftest is finished.

Finally, there's the **Calibration wizard**.

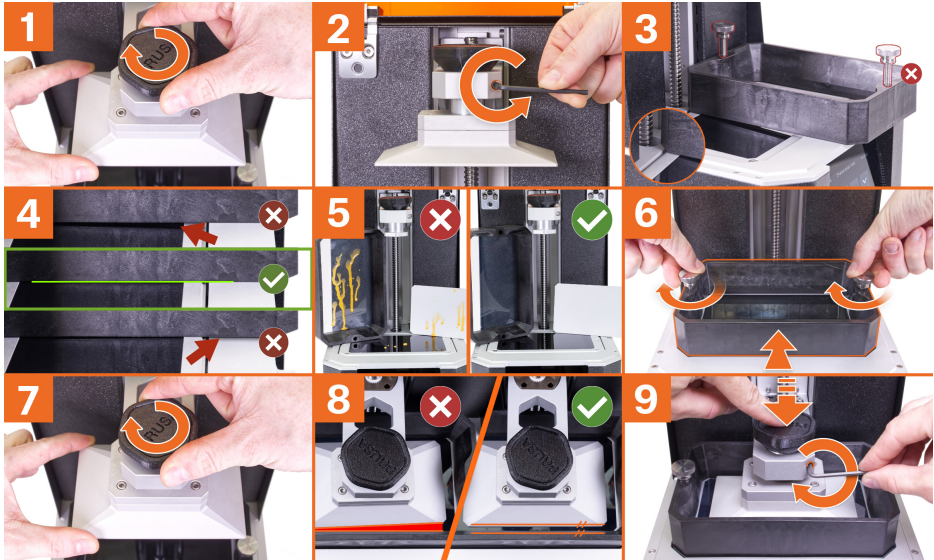

1. Make sure the print platform is clean, slide it onto the platform holder on the cantilever and tighten the black knob.
2. Loosen the screw on the cantilever using an Allen key. The platform should move quite freely, but the knob on top has to remain tightened
3. Take the empty resin tank, remove both large screws, rotate it by 90° and place it across the silver printer frame as depicted in the picture. Make sure the tank rests flat and level on the printer frame lip and **not on the display**
4. Use the on-screen controls to move the tilt until the display and frame are in direct contact with the resin tank. The tank must not be lifted above the frame. See the picture below for a reference. Tap or hold the on-screen buttons to move the platform.
5. Before you proceed further, make sure that both the platform and the tank are perfectly clean.
6. Place the resin tank on the tilt bed and secure it with both screws. Tighten them evenly and with the same amount of force, otherwise, the tank may end up in a skewed position
7. Make sure the platform is secured by the black knob.
8. The print platform will go all the way down and touch the bottom of the tank. Rotate the platform so it's parallel with the edge of the screen / side of the tank.
9. Apply a slight downward pressure on the black knob with one hand and use the other hand to tighten the screw on the cantilever.

That's it! The printer is now calibrated and doesn't have to be calibrated again unless you transport it to a new location or replace certain parts of the printer (e.g. the FEP foil). The print platform is secured by the black knob at the top of the cantilever and removing it from the printer won't affect the calibration.

Once the calibration is done, the Main Menu is displayed. Please see the chapters ***Navigating the menus*** and ***Menu structure*** for more information.

4.3. Navigating the menus

SL1S uses a **touchscreen display** for navigation and for configuration of basic and advanced features. To enter a sub-menu (e.g. Print, Settings...), press the desired icon on the screen. **To go back** to the previous screen, press the **Back on-screen button**. To change values in various sub-menus, use the on-screen symbols (such as + and - or arrows up and down). Pressing and holding a symbol results in a **continuous increase or decrease** of the associated value. Some screens can be swiped to reveal additional information - these screens are marked with little dots at the bottom of the page.

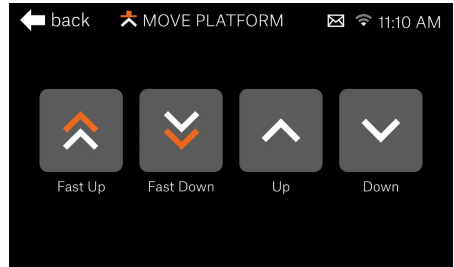
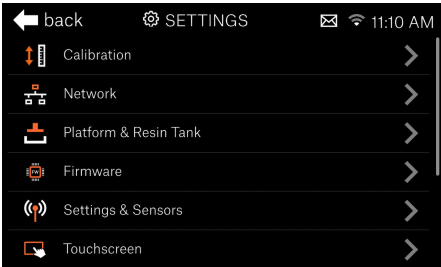

Use touchscreen controls to navigate the menus. Use short or long button presses to change the on-screen values

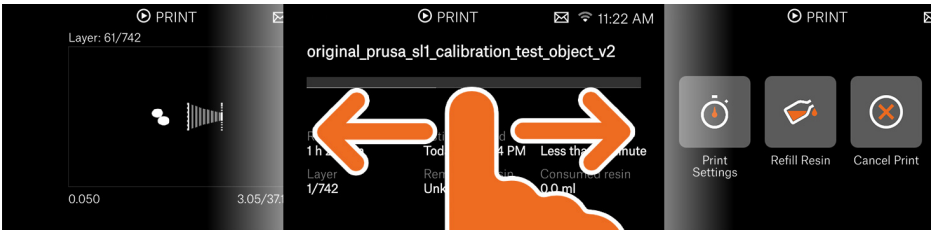

4.4. Updating the printer's firmware

It's a good practice to **keep the firmware up-to-date** all the time because newer versions come with new features, bugfixes, and improvements.

If you don't have the printer connected to the internet, you can **update the firmware using a USB drive**. Download the firmware file from <https://prusa3d.com/drivers>, place it on a USB drive and plug it into the printer. Then, go to **Main Menu - Settings - Firmware**.

The printer is capable of checking for updated firmware online. Navigate to **Main Menu - Settings - Firmware** and enable automatic firmware checks. This functionality requires a working internet connection.

4.5. Network connection - recommended

Before you start the calibration process, it is advised to **connect the printer to the internet**, so that it can download updated firmware files (if they are available). There are **two ways** how to connect the printer to the internet.

4.5.1. Internet connection - Ethernet cable

You can use a standard **RJ-45 ethernet cable**. Connect it to your router, and the printer should obtain an IP address automatically - however, this depends on your network configuration. Since every network is different, please refer to your router's instructions or your provider's tech support in case you run into trouble. To check whether the connection has been successfully created, go to **Main Menu - Settings - Network**.

4.5.2. Internet connection - Wireless connection

The SL1S 3D printer has a **built-in Wi-fi network card compatible with 2.4GHz networks**. To open the Wi-Fi network browser, go to **Settings - Network**. A list of all available networks will be displayed. Select your Wi-Fi network and connect to it by typing your password using the on-screen touch keyboard. You can connect a USB keyboard to the front USB port in case the on-screen keyboard is too small.

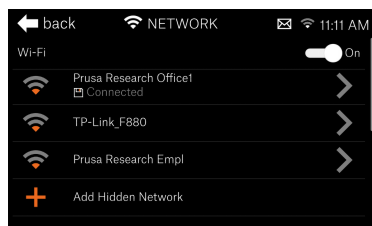

Network troubleshooting

Since every network is different, we cannot provide exact instructions on how to connect to your wireless/wired network. If you encounter any trouble, please refer to your router's manual, or contact your internet provider's tech support. Quality of your wireless connection depends on many factors - such as the type/configuration of the router, distance of the printer from the router or wireless interference in your area.

You can recognize a successful connection by looking at the icon in the top tray next to the time which also shows the signal strength. For additional connection details, navigate to **Main Menu - Settings - Network** and select the type of connection you're currently using.

4.6. Time and time zone configuration (optional)

You can configure the printer's time zone and current time in **Settings - Language & Time - Time Settings**. If you have the printer connected to the internet, you can use Automatic time settings to have the time updated automatically depending on your time zone. Next, you should go to the Timezone menu and select your continent and nearest town/city. If you don't have the printer connected to the internet, please set the time manually using the Date and Time options.



Setting the correct time is useful - the screen will show you when the print job is going to finish.

4.7. Pouring resin into the tank

Before you start printing, always make sure the FEP film on the bottom of the tank is clear (transparent), clean and has no holes, dents or deep scratches. Check the tilt platform with the display and make sure it is completely clean and there is no debris anywhere.



Wear gloves when handling resins!

Place the tank on the tilt platform. There is a **small groove** running around the tilt bed that will help you to position the tank properly. You may hear a little "click" as it falls into place. Use the two resin tank screws to secure it to the tilt bed. Tighten screws **simultaneously and with the same amount of force**, otherwise the tank may end up in an uneven position.

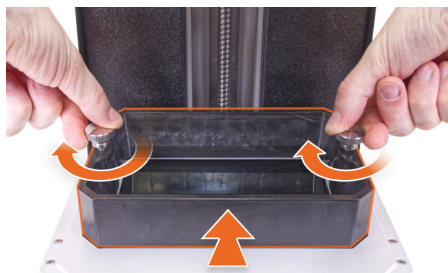

Tighten both screws simultaneously and with the same amount of force. Pour the recommended amount of resin - there is a max level mark in the tank.

Once the tank is secure, **pour the resin in it**. Notice that there is a **max level mark** in the tank that will help you measure the optimal volume. The SL1S features a built-in resin level sensor, so in case there's too little or too much resin, the printer will pause and display an on-screen info message. Please follow the on-screen instructions to fix the issue.



Do not overfill the tank!

Any time you are asked to refill the resin to the max, it always means adding it up to the 100% mark, not to the edge of the tank!

4.8. Running out of resin / Adding resin mid-print

The SL1S features a built-in resin level sensor, which measures the amount of resin in the tank before every print. Some models might be **too large** and require **more than the maximum amount** of 200 ml resin in the tank. The printer can recognize when the resin starts running low and **pauses the print**. An on-screen message is displayed, asking you to fill resin back to the max level mark. Once you refill the resin, you can press the on-screen **Continue button** to resume the print.



Keep in mind that in certain cases (especially if the print has been paused for a long time), the new layer may not adhere perfectly to the rest of the object - or not adhere at all.

4.9. Starting the First print

One last check before you start the first print:

- Is the printer updated to the latest firmware version?
- Did you calibrate the printer using the wizard?
- Have you checked the FEP film in the tank?
- Have you poured the correct amount of resin into the tank?
- Have you degreased the print platform with IPA?
- Is the lid closed?

Go to *Main Menu - Print - Examples*. A list of available print files will show up on the screen.

Swipe the screen up and down to scroll through multiple entries. Start with a sample model - these models are ideal for the first print because they will show clearly, whether the printer has been **calibrated correctly**. Tap the model to select one of them and then confirm the selection by pressing **Continue**. If "Examples" aren't available in the Print menu, go to **Main Menu - Settings - Support - Download Examples** and download them (internet connection required).

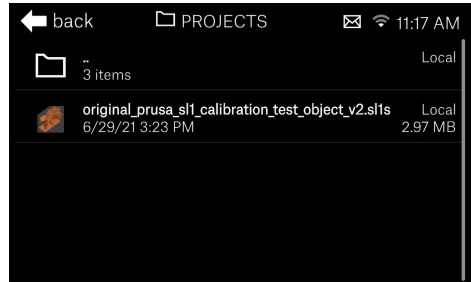

Once you select an object to print, you will be presented with a **preview**. You can check the thumbnail to **make sure you selected the correct file to print**. Swipe to the left to enter the print setup screen. Here, you can either **start the print** or go to Print Settings and adjust the exposure for normal layers, for first layers and also switch between two print profile modes. The faster print mode is the default one. If you encounter issues during the print, especially if the printed object detaches from the print platform, consider using the slower profile. If you're printing a sample object, everything is already pre-configured. Press **Print**.

The printer will **perform a quick self-test** and start printing. Keep the lid closed and do not interrupt the print. Since the print platform is **submerged in the resin**, you can't see whether the first layer attached correctly. Try listening for the **typical noise** that comes with the layer separation - it sounds a bit similar to the sound of a sticky tape being removed. Don't panic if you don't hear it clearly, though.

Even if the first layer won't stick to the print platform correctly, there will be no permanent damage to the printer.

The SL1S runs several pre-print checks in parallel. You can see the progress on the screen. In case any of the checks fails, a warning is displayed on the screen along with a QR code which you can scan with your phone to display a relevant troubleshooting article. Please refer to the last chapters of this handbook for troubleshooting guides, or visit help.prusa3d.com

4.10. Removing the print



Safety instructions - wear gloves!

When handling resins, always wear protective gloves and always clean up any drops of resin around the printer. In case the resin gets into contact with your skin, wash it off immediately with water and soap. If you experience discomfort (such as itching) or the resin gets in your eyes, seek out a doctor immediately.

After the printing process finishes, open the lid. Consider using a protective tray (optional accessory sold separately) as depicted in the picture.

Use a **plastic spatula or paper towels** to wipe the top part of the print platform clean. Then, **unscrew the black knob** at the top of the tower to unlock the platform. Carefully slide the print platform out, and turn it sideways, so the **remaining resin goes back to the tank**.



Use the **bundled metal spatula** to remove the print from the print platform. To prevent injuries, **do NOT use your fingernails** to remove the prints since the plastic can easily get under your nails and break off.



Removing a printed object with a metal spatula

Inspect the printed sample object. Check for any **inaccuracies, missing parts, visible layers/lines, dents, blobs, and other defects**. If your print has visible defects, check the last chapters of this handbook for print quality troubleshooting.

You should **clean the print platform thoroughly after every print** - drops of liquid resin can solidify in sunlight, which would make them difficult to remove. Clean the channel at the top of the print platform thoroughly. Use isopropyl alcohol to clean the platform.



4.11. Removing a print stuck to the bottom of the tank

In case the first layer did not stick to the print platform, it remained **stuck at the bottom of the tank**. No matter how big or how small the stuck layer is, there's a quick safe way that will help you remove it from the FEP film without damaging it - see chapter **15.1 - Removing an object stuck to the bottom of the tank**.

4.12. Removing supports

Supports for SLA printers are designed to be **thin, yet strong enough** to support the printed material. The end of support is called a support head which is usually even thinner than the rest of the support, which makes them **easy to remove**, leaving little to no trace on the object itself. However, heavier or larger objects **may require stronger (thicker) supports**.



To remove supports from 3D printed objects, there's a couple of things to keep in mind:

- It's easier to remove the supports **directly after** the model is 3D printed and washed in isopropyl alcohol. Curing the model with supports still attached can make the supports more difficult to remove (although this is often resin-specific)
- **Don't use excessive force.** Instead, use the bundled pliers to carefully remove the supports.
- To achieve **better results** (especially with tiny objects), try cutting the supports in the middle first, then proceed to the ends. Another good option is to **rinse the supports in hot water for a short while**. Supports will become softer and will be easier to remove
- Removed supports should be treated as **plastic waste**

4.13. Bundled 3D models

The Original Prusa SL1S comes with several bundled models. These models are pre-sliced and their purpose is to **provide a benchmark for end users**. By including complex geometry, extremely thin lines and miniature patterns, these models will give you a good overview of whether your printer has been **calibrated correctly**. The models are pre-sliced, so if they don't print correctly, you can be sure the problem is not in slicing settings.

To **delete the example objects** from the printer's internal memory, or your own projects from the USB drive, go to the Select Project menu (*Main Menu - Print*), slide any of the projects to the left to reveal a waste bin icon. Tap this icon to immediately delete the project.

You can find the sample models in the printer's menu. Go to Print - Examples to display a list of sample models. All samples are designed to be printed with the Prusa Orange resin. If you decide to use a different resin, modify the default values!

5. After-print checks and actions

The SL1S needs to be **cleaned up after every print** to avoid potential damage to the printer. Failure to maintain your printer properly may lead to severe damage and loss of warranty.

- **Never leave the resin in the tank** after a print finishes. There may be tiny bits of solidified resin left in the tank, which could potentially damage the FEP foil or the display the next time the print platform would go all the way down. Also, resin could solidify directly in the tank if you keep it in for extended periods of time.
- After you pour resin out of the tank, take a **very soft paper towel** and wipe the tank clean. Make sure no resin has been left on the outer sides of the tank or on the underside.
- If the FEP film has a **greyish tint** (it's not completely clear), you can restore it to the original look by cleaning it with warm water combined with a bit of dishwasher soap or regular soap. Alternatively, you can use IPA. Dry it thoroughly afterward.
- **Clean the print platform** - use paper towels to wipe the platform clean or wash it carefully in isopropyl alcohol. Read instructions on the IPA bottle before use.

5.1. Washing / Curing / Drying models



Until the models are completely cured, there may be trace amounts of liquid resin or IPA on their surface. Wear gloves when handling uncured objects! This applies especially to the following chapters.

Prints made of solidified resin tend to be **slightly soft and sticky**. To reach optimal surface properties, it is necessary to **wash, dry and cure the print**. We recommend using our own **Curing and Washing Machine** (CW1S for short). It's a 4-in-1 device: it can wash the object in isopropyl alcohol, dry it using hot air and cure it with UV light - all in a matter of minutes and without any extra hassle. It can also preheat your resins to optimal working temperature.

The Curing and Washing Machine features a rotating platform and a lid with a reflective surface that improves the overall performance, reducing the total time needed to perform all three actions to less than ten minutes.

Without the Curing and Washing Machine, you have several options:

5.1.1. Washing

Resin-based prints should be **always washed in isopropyl alcohol (IPA)**. Exercise caution when dealing with this liquid - it's flammable and it shouldn't get in contact with your skin or eyes. **Always read the instructions on the bottle before using it.**

When you wash prints in IPA, try moving them around or use a small and very soft brush/toothbrush to properly clean all parts of the object. The print can usually stay submerged in IPA for several minutes without any noticeable decrease in surface/material quality. **Don't keep the object submerged in IPA for extended periods of time** (hours or days). If the print develops various cracks (even after 24 hours), it's usually because the print has been kept in IPA for too long.



5.1.2. Drying and curing

Use a **soft paper towel** to dry your print and/or put it on the windowsill - ideally in **direct sunlight**.

Curing the model without a strong UV light source can **take a long time**. One of the common practices is to place the model in direct sunlight for an extended period of time (e.g. 24-48 hours) depending on the intensity of sunlight. The CW1 can cure an object within 3-5 minutes.

Protip: You can use a **UV LED nail lamp dryer** (a machine used for curing nail polish). They run around 30-40 USD and they can cure the surface of a resin-based print quickly and efficiently. Just make sure to get a product with a chamber large enough to accommodate the prints.

The drying mode can also be used to preheat resins.

5.2. Disposing of resins



Used resins should be treated as dangerous liquids (same as motor oils etc.). See your country's laws that cover the disposal of dangerous waste / liquids / chemicals to learn more about this matter. Liquid resin must not be, under any circumstances, poured into drainage or sewerage (e.g. into a sink).

After you finish a print, we recommend **pouring the leftover resin into a new bottle**, so it doesn't mix with unused clean resin. Used resin may contain tiny solidified bits that may affect the quality of the next print or even damage your printer. Also, since the resin has been exposed to UV light, its properties might have changed slightly.

We recommend curing the paper towels soaked with liquid resin in a curing chamber (either our Curing and Washing Machine or a UV LED nail lamp dryer). Another option is to leave them in direct sunlight to cure the resin, then treat them as plastic waste.



Use the bundled funnel with a filter to pour used resin into a bottle (don't mix old and new resins). Clean the tank thoroughly after every print.

If you decide to use the resin again anyway, always make sure the liquid is **properly filtered** and does not contain any solidified leftovers from previous prints. If the print quality is lower with reused material, consider switching to an unused resin. Clean the filter often to prevent clogging.

5.3. Menu structure and advanced functions

- Print
 - File Browser
 - Project overview
- Control
 - Home Platform
 - Home Tank
 - Disable Steppers
 - Resin Tank Cleaning
- Settings
 - Calibration
 - Selftest
 - Printer Calibration
 - Display Test
 - Network
 - Ethernet
 - Wi-Fi
 - Hotspot
 - Hostname
 - Login Credentials
 - Platform & Resin Tank
 - Move Platform
 - Move Resin Tank
 - Disable Steppers
 - Platform Axis Sensitivity
 - Tank Axis Sensitivity
 - Limit for Fast Tilt
 - Platform Offset
 - Tank Surface Cleaning Exposure
 - Firmware
 - Installed version
 - Check for Updates
 - Receive Beta Updates
 - Switch to another version
 - Factory Reset
 - Settings & Sensors
 - Device Hash in QR
 - Auto Power-Off
 - Cover Check
 - Resin Sensor
 - Rear Fan Speed

- Touchscreen
 - Screensaver timer
 - Touchscreen Brightness
- Language & Time
 - Set Language
 - Time Settings
- System Logs
 - Last Seen Logs
 - Save to USB Drive
 - Upload to Server
- Support
 - Download Examples
 - Manual
 - Videos
 - System Information
 - About Us
- Turn Off



The top menu bar with time and network information can be pulled down to reveal a notification area.

6. Printing your own models

Once the printer is fully calibrated and the sample models are looking good, you will probably want to **print your own model**. You have a number of options - read the following chapters to learn more.





6.1. Obtaining a printable model

The easiest way to get started with 3D printing is to **find models on the internet** - they are usually in .3mf, .stl or .obj formats. Fortunately, 3D printing has many fans, so there are sites from which you can download a large variety of ready-made 3D models for free. These range from a simple playing dice to a detailed figure from a favorite movie, game or TV series. You can also download mechanical parts, RC model accessories, household items and much more.

Get the best models at Printables.com

Printables.com (formerly PrusaPrinters.org) is a **large online library of high-quality 3D models** managed by Prusa Research. The main goal is to bring together a large active community of designers, makers and 3D printing enthusiasts - no matter which 3D printer brand they prefer. There are **regular community contests** with 3D printers and filaments as the top prizes and there's also a **reward system with both virtual and physical goods** - simply by being an active member, you can **collect points and exchange them for a spool of Prusament or cool merchandise**.

With the focus on high-quality, unique and useful models, you are **always just a few clicks away from discovering something new and amazing to print**. And before you actually download and print something, you can use an **advanced built-in 3D model viewer** that works with not only STL and 3MF files, but G-Codes as well. Visit Printables.com and discover all sorts of activities, contests, events, groups, collections and more!

English     

 Models Education Events Groups Prusa Blog Eshop

+ CREATE

BETA

PRUSA PRINTERS

Welcome [Printables.com](#) 🎉

The ultimate library of 3D models for everyone!

 **Printables**
by JOSEF PRUSA

READ MORE

Featured Prints

 occupied brain



Pierced!
Costumes & Accessories > Props

37 ❤️ 5 ⭐ 180 📄

 M4NU



Skull Chain - Print-in-place b...
Fashion > Other Fashion Accessories

32 ❤️ 3.7 ⭐ 120 📄

 Julia Ebert



Mega Lego-like Skeleton (10...
Toys & Games > Building Toys

120 ❤️ 4.9 ⭐ 470 📄

 robin3dverse



Witch Support Free Remix
Seasonal designs > Autumn & Halloween

37 ❤️ 4.9 ⭐ 360 📄

EXPLORE PRINTS

However, models in .stl, .obj or similar formats **cannot be 3D printed directly**. First, they need to be **“sliced” (converted)** into a SL1S file, which is then placed onto a **USB drive**. Connect the USB drive with a sliced project into the printer and select the model to print from the Print menu. Please see the chapters **6.3 What are SL1S files?** and **6.4 PrusaSlicer** for more information.

- <http://www.printables.com>
- <http://www.thingiverse.com/>
- <http://www.myminifactory.com>
- <https://pinshape.com/>
- <https://www.youmagine.com/>
- <http://www.shapeways.com/>
- <http://www.gambody.com>

6.2. Creating your own models

To create a 3D model, you need a **dedicated program** - a 3D editor. There are a number of various 3D programs and your choice will usually depend on what type of model you wish to create.

The **easiest place to start** is TinkerCad (www.tinkercad.com) - it's an online editor that runs in your browser's window, so no installation is required. It's free, easy to navigate, and you will find plenty of tutorials online. However, TinkerCad is mostly focused on **creating less-detailed and larger (e.g. mechanical) parts**, often ideal for FFF/FDM printing. Another popular tool is **Autodesk Fusion 360** (www.autodesk.com/products/fusion-360) for PC, Mac, and iPad. The website provides a quick guide along with detailed video tutorials so it is an ideal choice both for beginning enthusiasts and professionals.



To fully utilize the precision of the SL1, you should focus on programs such as Blender, Zbrush, Maya, SculptGL, MakeHuman, SketchUp, Clara.io, Moment of Inspiration or 3D Studio Max. These applications are better for creating organic shapes (such as characters or character parts), but only a few of them are free.

6.3. What are SL1S files?

Before you can 3D print a downloaded or created model, you need to convert it into an SL1S file first. This is typically done by a process called “slicing”, which requires a special software - **PrusaSlicer**.

Essentially, the slicer takes a 3D model and cuts it into thin layers. Each layer is saved as a separate PNG file. These files, along with a configuration INI file, are stored in a compressed ZIP file, which is automatically renamed to SL1S. If you rename SL1S back to ZIP, you can inspect the content of the file.

6.4. PrusaSlicer

PrusaSlicer is **our own open-source tool for slicing models**. It's the only slicer you will ever need for your Original Prusa printers! It contains print profiles and recommended settings for the entire range of Original Prusa devices.

You can **download the latest version** of PrusaSlicer from www.prusa3d.com/drivers (stable releases) as a part of the Apps & Drivers package. The Original Prusa SL1S SPEED is supported in PrusaSlicer 2.3.2 and newer.

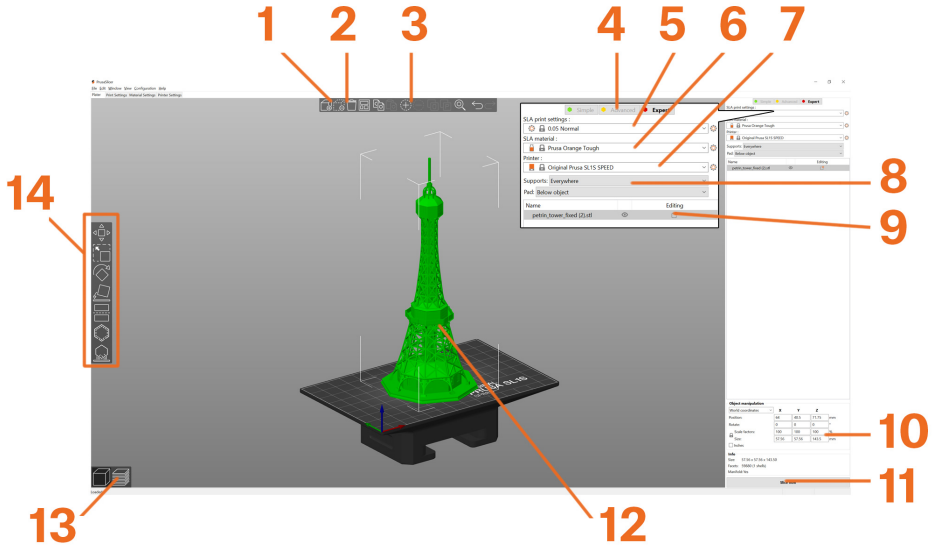

1. Add object
2. Remove object / Remove All
3. Add / Remove an instance of an object
4. Switch between Simple / Advanced / Expert mode
5. Layer height
6. Liquid resin type
7. Printer selection
8. Generate supports / Use pad checkboxes
9. Object modifiers
10. Object size / scale information
11. Slice Now and Export G-code buttons
12. 3D object preview
13. 3D editor view / Preview window switching
14. Move, scale, rotate, place on face, cut, hollow and support tools - explained in the following chapters

Basic importing, slicing and exporting 3D objects is simple. However, PrusaSlicer has advanced menus and settings for experienced users, allowing for a higher level of control.



Want to learn more about PrusaSlicer?

Visit our Blog at <https://blog.prusa3d.com> where we publish tips, tricks and extensive guides that will turn you into a master of slicing!

6.5. Slicing objects for the SLIS

Every 3D model is different, so an **individual approach is needed for every single object**. However, we can still offer several tips, tricks and hints that will make the slicing and printing processes easier. If you already have experience with FFF/FDM printing, you will notice that **the preparation of models for SLA printers is slightly different**. These chapters will explain all the steps required for a successful preparation of a model for printing - this covers support generation, explanation of terms such as pad, exposure or layer height, and many other things.



Learn about SLA supports!

SLA has a completely different type of supports and different object orientation compared to FFF/FDM 3D printers. If you already own one of our Original Prusa i3 3D printers, you should check out the main differences below.

There are several goals you should try to meet as closely as possible when preparing an object for slicing/printing.

- **SLA is an additive manufacturing method** - objects are created layer-by-layer, which means that layers are added on top of existing ones and they cannot be created mid-air. Such parts must be supported with supports, a scaffolding-like structure. Choosing a good object orientation minimizes the amount of supports needed. Supports for SLA are different compared to FFF/FDM 3D printers.
- **Decide when to use the pad and/or supports** - for some objects, using the pad and supports is not mandatory. One of such examples is the model of Eiffel tower. It has four reasonably sized contact points, which can be placed directly on the print platform. Since the tower rises at an optimal angle, no supports are required.
- **Tilted models produce better results** - when you have an object with a large flat base, it's a good practice to rotate it, so it raises under an angle of around 45° in two axes depending on the model's shape. Tilted models require lesser peeling force during layer separation process
- **Decide between quality and "safety"** - even though supports for SLA printers are tiny compared to FFF/FDM printers, they can still leave small marks on the object's surface. If you rotate the object so the important parts are facing away from the print platform, it will help you to conserve details on the print. However, sometimes it's better to add a higher number of supports for a "safer" print - especially when printing larger objects that may detach due to their weight. Thicker supports are an option, too.
- **Object orientation affects the print time** - tall objects will take longer to print than shorter ones. Consider rotating the object to save time.

- **Consider making the printed object hollow** - SLA prints in general can sometimes fail due to excessive suction: basically, when you print an object, the printer needs to separate it from the tank bottom. If the print has a large flat area or a cavity, the suction can be so strong, the object will detach from the supports / print platform. PrusaSlicer has a Hollowing tool built-in.
- **Using “bridges” is not recommended** - FFF/FDM 3D printer users know a method called bridging. It means the printer can extrude and cool down the string of filament in mid-air to overcome a gap between two points even without using supports. However, this is not recommended for SLA printers. The first layer of the “bridge” is usually too thin and flexible, so the rest of the layers won’t adhere perfectly and little cracks and gaps can appear. Add supports or find a better orientation for the object.
- **ALWAYS carefully check the sliced object** in the Preview window and make sure that there are no unsupported parts of the model or other issues that would cause the print to fail

6.6. Importing an object into PrusaSlicer

Once you start PrusaSlicer, select the **Original Prusa SL1S** in the *Printer menu* on the right side of the window. If it’s not listed, you can add it either by selecting Add a new printer option in the same menu, or by going to *Configuration -> Configuration Wizard*. Then, select the **layer height** in the SLA print menu and finally the resin you want to use. Please note that built-in resin profiles have pre-defined and tested settings. If you select a wrong profile, it may affect your print due to incompatible exposure times.

PrusaSlicer allows you to **import STL, OBJ, AMF and 3MF object files** - these are the most common types of 3D files you can find on the internet. You can either drag-and-drop them in the Plater window, or you can use the **Add...** button in the top toolbar.

Next, use the tools in the left toolbar to **Move, Scale and Rotate the model**. If the object is blue, it means it’s too big for the print platform. See the next chapter (**6.7 Positioning an object**) for more details. **Every object is different**, so there’s no default orientation that would work for every object. However, you can find a couple of examples in the next chapters that will give you a better idea how to rotate and support certain types of objects.

6.7. Positioning an object



Move tool (M) - moves the object in XYZ axes. Click and drag the object to move it in XY axes, use the blue arrow to move it in Z axis (up and down).

Scale tool (S) - scales the object, either uniformly or in a single axis. You can adjust the values in the right-side menu by entering numbers in Scale factors section. Entering 100 resets the object to original size.

Rotate tool (R) - rotates the object in X, Y or Z plane. Click and drag one of the rotation gizmos to rotate the object smoothly or in steps (by dragging it along the circular guide).

Place on Face (F) - displays selectable “faces” (sides) on the object. Click on a face to automatically position the object so it lays down flat on the selected face. Useful for objects with a flat base, or if you want to rotate an object quickly.

Cut tool (C) - For splitting an object. In case you have a model that has an unwanted part (e.g. a base under a figure), you can use the cut tool to cut the model in half. You can decide whether to keep both parts of the model or delete one of them. Cuts can be made only in plane.

Hollow and drill (H) - Only available when you have the Original Prusa SL1S selected. Allows you to create a hole inside the object to decrease the weight and save material. Please refer to chapter Hollowing in PrusaSlicer for more information

SLA Support points (L) - Only available for Original Prusa SL1S. See the next chapter for detailed explanation.

6.8. How to generate supports for SLA prints

Supports are an extremely important tool - it's rarely possible to print an object completely without supports. Compared to FFF/FDM 3D printers, resin-based printers **usually require more supports**, because the models should be printed lifted above the print platform and under an angle to achieve better results. However, **SLA supports are thinner and easier to remove**. PrusaSlicer is fully equipped for automatic support generation, as well as manual editing.

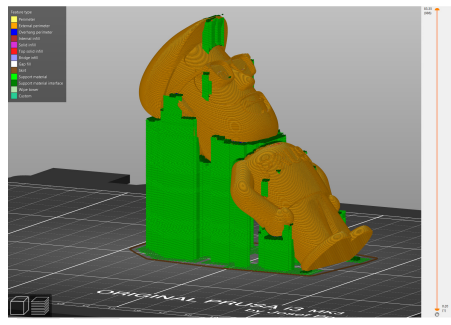
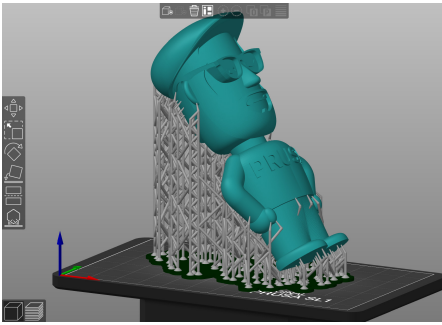

Comparison of SLA supports (left) and FFF supports (right)

Each print will require a **slightly different approach** based on the shape, size and details present on the model. In this chapter, we'll explain the basics of support creation in general. For more examples, see next chapters.

Decide whether the object you are slicing **requires a pad**. The pad (see chapter **6.9.1 Pad**) is a **base for the model and supports**, which makes printing and removing the object easier. Some objects with a moderately sized flat base don't need a pad in order to be printed successfully.

In the **right-side menu**, you can choose to **turn on/off the pad** and also select the **type of supports** that will be generated: **None** (no supports will be generated), **On build plate only** (the supports will be generated only on the print platform), or **Everywhere** (supports will be generated everywhere, that means even between various parts of the model - this might be necessary for complex shapes). You can then move onto support generation, but you can always come back and change these options.

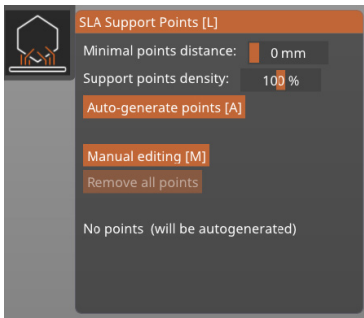

In the picture on the left is the **SLA Support Points** menu, which can be found in the left-side toolbar. If you can't open it, it usually means the model you have imported is too large for the print bed. Move, rotate and scale the object so it fits - the object should be displayed in green colour.

Minimal points distance: specifies how far apart the attaching points for support heads should be generated. The default value is 1 mm.

Support points density: specifies how many supports will be generated. Larger and heavier objects will require more supports. Support points density takes the Minimal points distance into account.

Auto-generate points - starts generating the supports based on configured parameters. You can re-generate the supports if you are not satisfied with the result and decide to change the values.

Manual editing

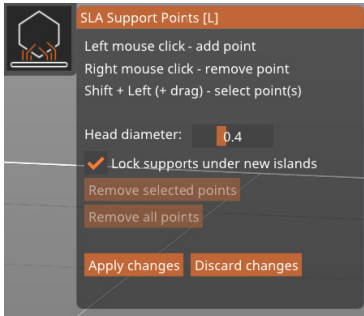

Clicking the Manual editing button opens a new menu and a new set of tools, which enable you to manually add, remove and modify support points on the object. Use Left mouse click to add a support, right mouse click to remove a support, and combine Shift+Left mouse to drag a selection box to select more supports. You can left-click and drag a support point to reposition it.

Manual editing of supports is useful when the automatic generation doesn't deliver a perfect result. Once you have sliced and printed a few objects, you will be able to recognize which parts of the model may require extra supports - those are usually places we call "islands", basically the critical parts that start mid-air. It's a good practice to add a few extra supports to these places to ensure that the model will withstand the peeling forces.

- **Head diameter** - specifies the size of the support head. The maximum value is 1 mm by default - this can be changed by modifying the support diameter in *Print settings* -> *Supports* -> *Support pillar diameter*. Increasing this value may require increasing the Object elevation value as well. The default value for support head diameter is 0.4 mm and it's suitable for most objects. Larger and heavier objects may require stronger connections (higher values). The support point gizmo has a small cone-shaped part that shows the direction in which the support will be attached and its size.
- **Lock supports under new islands** - these are the critical parts of the object that often start mid-air. Automatic generation of supports can recognize these parts and creates supports for them accordingly. If you decide to manually edit the supports, you can "lock" these critical points so you don't accidentally delete them
- **Remove selected points** - removes the points that you have selected (e.g. by Shift+left clicking them). Selected points are marked red. Locked points won't be deleted.
- **Remove all points** - removes all points, including automatically generated and even locked points
- **Apply changes** - confirms the changes and returns to the previous menu
- **Discard changes** - discards manually made changes and returns to the previous state

6.9. Pad, supports, layer height and exposure times

There are several tools and settings that will help you print **even very complex objects** without a hitch. **Pad and supports** are useful for achieving a good object positioning on the print platform, while the **layer height and exposure times** affect the number of details on the object, as well as the overall printing time. However, the print time is mainly affected by the total height of the object.

6.9.1. Pad

The pad is a structure generated **under the print** - it's the base for supports. You can easily **detach the pad** along with the print from the print platform with a spatula. **The pad is recommended**, however, it's also possible to print certain objects without it, depending on the object's shape. The pad can be turned on/off in PrusaSlicer. If you want to **print with supports**, using a pad is strongly recommended

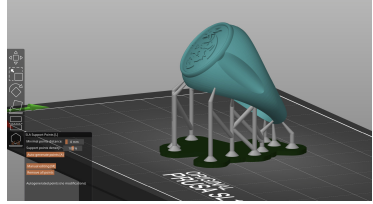

6.9.2. Supports

SLA printing is an additive manufacturing method: **every new layer needs to have something below it**, so there's something to build upon. It's **not possible to start a new layer mid-air**. You can either rotate the object until you reach optimal angles, so the overhangs are small enough, or you can use supports. Supports are **scaffolding-like structures that are automatically or manually generated in PrusaSlicer**. Supports for SLA printers are very thin and they have pointed ends, so the contact area with the model is as small as possible. Supports have various settings (thickness, support head diameter, object elevation...) and you should change these settings based on the object you want to print. **Heavier/larger objects require more (or thicker) supports.**

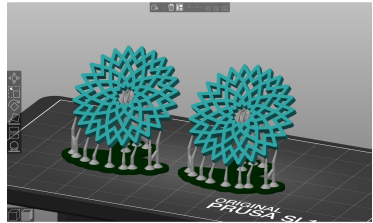

6.9.3. Layer height explained

Compared to FFF/FDM printers, MSLA 3D printers have a fixed XY resolution (determined by the resolution of the LCD screen), so **the only axis, that dynamically affects the looks of the model, is the Z-axis**. How much the Z-axis (the tower with the print platform) moves between layers is determined by the layer height settings.

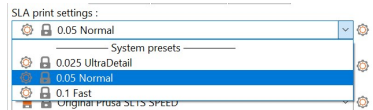

The technology in the SL1S enables it to reach a layer height of 0.01 mm. However, this value is not recommended for regular use, since there's no real benefit in using it. Instead, **we're offering our presets with 0.025, 0.05 and 0.1mm layer height**. With the SL1S printer, 0.05 mm is considered the "normal" quality and we recommend sticking to it - it offers a good balance between speed (time) and good surface finish with almost invisible layers. **Lower values will result in better surface finish, but also in longer print times.** Please note that certain resins are limited to a narrower layer height range.



Using lower layer height will lead to more detailed objects, but the print will take much longer to finish. To see an estimation of how long a print will take with various layer heights, check the PrusaSlicer window after you slice an object.

Info

Size: 61.82 x 52.06 x 44.01

Facets: 43992 (1 shells)

Manifold: Yes

Sliced Info

Used Material (ml) : 5.19

- object(s) 2.31

- supports and pad 2.88

Estimated printing time : 3h 33m 16s

PrusaSlicer can estimate the printing time and amount of resin needed

6.9.4. Exposure time explained

PrusaSlicer allows you to **change the exposure time** (the number of seconds for which a single layer is cured) for standard layers and first layers separately. There are no “universally usable” numbers, so **we recommend using the preconfigured PrusaSlicer profiles**. We have tested over a hundred of different resins, and prepared tested profiles for each of them. Using our built-in profiles is recommended. If the resin you bought is not listed in PrusaSlicer, **you can tweak the values yourself** - sticking to 1.8-2.2 seconds for standard layers and 12-25 seconds for first layers is a good practice.

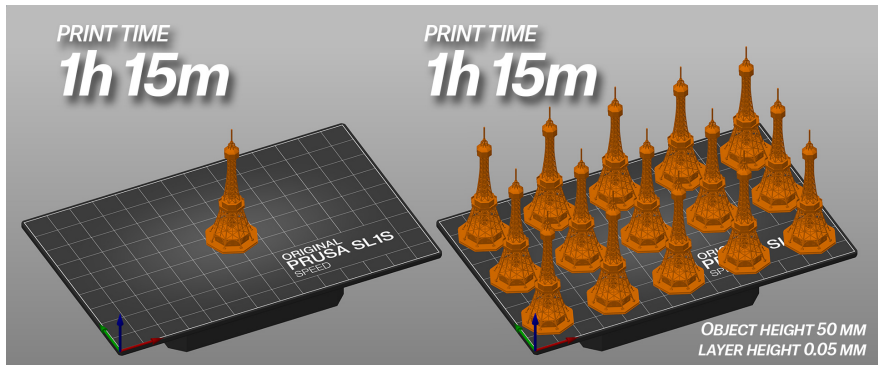

The SL1S features a **high-performance UV LED panel**, which has enough power to reach very short exposure times while retaining great surface properties of the printed model. Going under 1.6 seconds is possible, however, **most resins won't solidify in such a short amount of time**. The prints will start to lose detail or won't have enough time to solidify completely, and won't stick to the rest of the object, resulting in a failed print. However, some resins on the market can be cured with as low as 1.4-second exposure (e.g., transparent resins). The best option is to **use resins with pre-made presets in PrusaSlicer**, which also feature correct exposure times.

It is possible to change the exposure time before, or even during the print by going into *Settings menu* -> *Change exposure time*. However, changing exposure during print may result in visible lines across the printed object. Extremely low or high numbers will almost always result in a failed print.



Important information about print times

Keep in mind that no matter how many objects (or how big) you place on the print platform, the exposure time remains constant, so each layer will be finished in the same amount of time. In other words, printing a single 10 cm tall object or a dozen of 10 cm tall objects placed next to each other will always take the same amount of time. This is a major difference when compared to FFF/FDM printers. Take advantage of it!

6.10. Slicing, exporting and printing custom models

Once your object is placed on the printing bed correctly and supports are generated, you can press the **Slice now** button. Slice will analyze and process the 3D model and turn it into a number of separate layers.

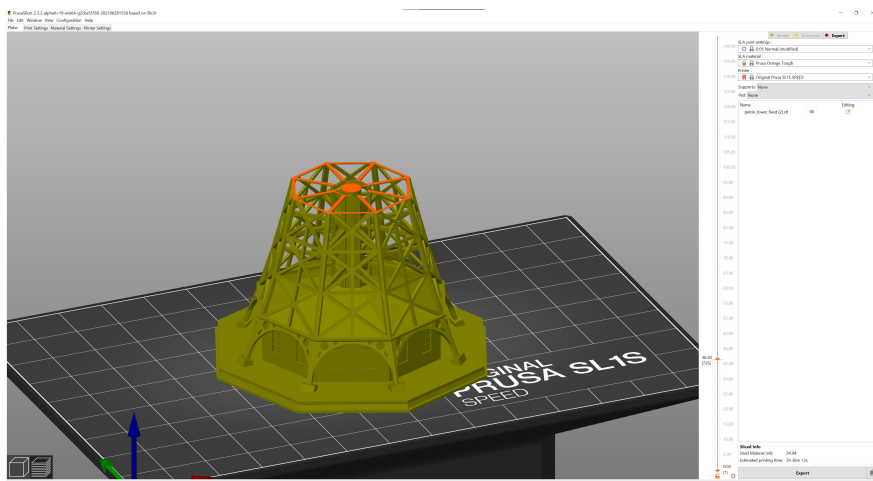

Inspect the object in the Preview window using the slider on the right side of the window. If everything seems to be ok, press the **Export** button to generate an .SL1S file. Place this file on a USB drive and connect it into the printer. Tap the **Print** icon to display a list of compatible projects on the drive. Select the desired model and confirm it with the Continue button. You can also upload files directly into the SL1's internal storage. See chapter **7 Connecting PrusaSlicer to SL1S over the network**.

6.11. Object orientation and slicing examples

There are different kinds of objects you can print, so it's nearly impossible to give exact instructions for every type of model out there. On the following pages, we're offering a selection of popular models and offer some tips on how to position them before printing.

6.11.1. Reims Cathedral

This is a very complex model which is actually very easy to slice and print. Disable supports and pad and use the place on face function to quickly rotate the object. Then use Scale, Move and Rotate tools to adjust the final placement before you slice the model.

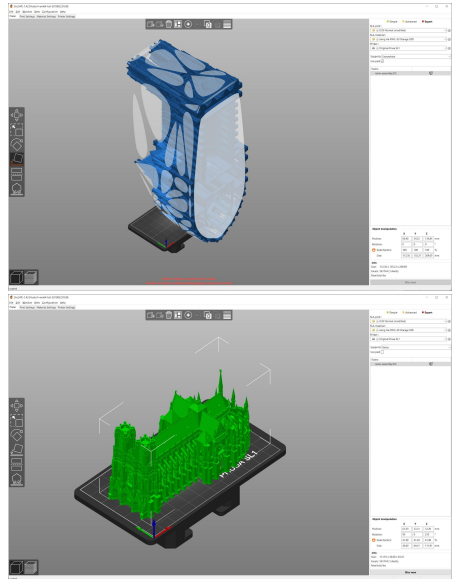
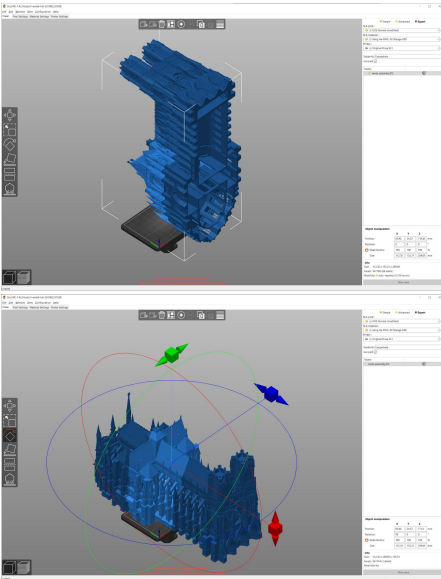

6.11.2. Petrin tower

This is another model that is very easy to slice. **Disable the Pad and Supports** and use the **Place on face** function along with move/rotate/scale tools to position the object until it's green (meaning it fits the print platform).

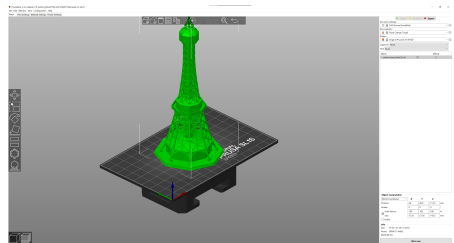
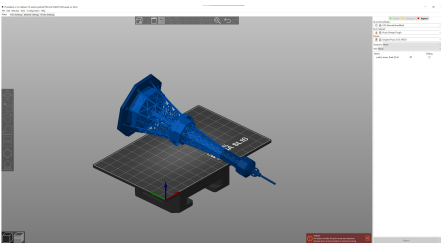

6.11.3. Jewelry

The Original Prusa SL1S is **perfect for printing tiny, highly-detailed models**. There's a couple of things to avoid in order to achieve a great looking surface. The most important thing to keep in mind is the fact that **supports can leave tiny marks on the object's surface**, so if your model has parts that should be printed perfectly, make sure there are no supports touching them.

You will need to use a **combination of the Pad, supports, Rotate/Move/Scale tool**. Also, configure the supports correctly in case the automatic generation won't deliver the desired result. Jewelry and similar objects are very small, so you don't usually need a ton of supports.

You can check the examples below to see how we positioned them before printing.

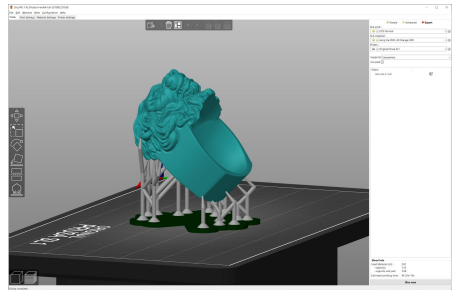
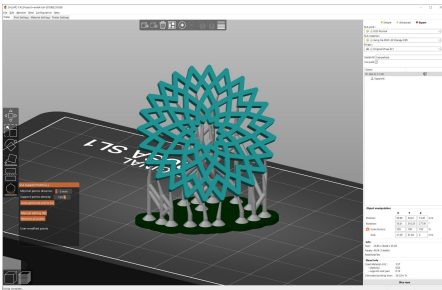

6.11.4. Characters and props

Characters and props are often some of the **most complex objects you can find**. The Original Prusa SL1S can handle the details on character models without any issue, so you can produce high-quality figures or props from your favorite movie or game.

Usually, you will need to use the **pad and supports, and adjust the density of supports** (or add extra supports manually) in case you decide to print a more complex object. Also, keep in mind that objects consisting of several parts, like body, arms, head and legs, can be a bit challenging to assemble in case the original model creator did not leave enough tolerance for joints or pegs. The only option is to adjust the problematic parts with a fine sanding paper. **Larger models should be hollowed first to reduce weight** - hollowing helps to save material and hollowed objects require less supports. See chapter **6.14 Hollowing objects**

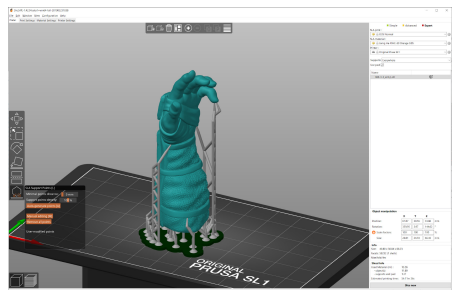
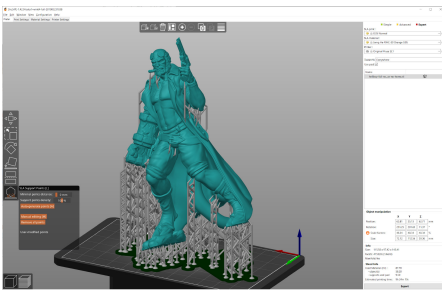

6.12. How to recognize problematic areas

Each time you slice an object, inspect it carefully in the Preview window. Never start a print without checking the model layer-by-layer first. The Preview mode will help you to discover problematic areas that could lead to a failed print. These are usually parts that aren't properly supported, broken model files, incorrectly placed holes (with the hollowing method) and similar issues.

Incorrectly rotated object - the SL1S will print it without issue, however, removing the supports may leave small marks on the detailed (and most important) part of the object.

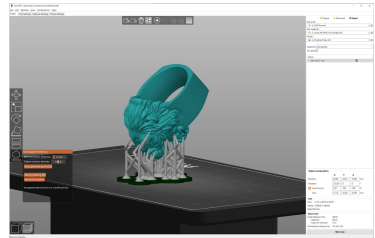

Bridging doesn't work the same way as with FFF/FDM 3D printers. The SL1S cures a single layer at a time, which in this case would most likely lead to layer separation due to peeling forces. Tilt the object by 45° and generate supports to print this object without issues.

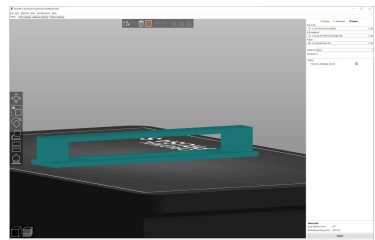

Insufficient amount of supports - the orange colour shows a single layer that the printer is going to cure and then attempt to separate from the bottom of the tank. The single support can't withstand the peeling forces. This usually happens if you set the support density to extremely low numbers.

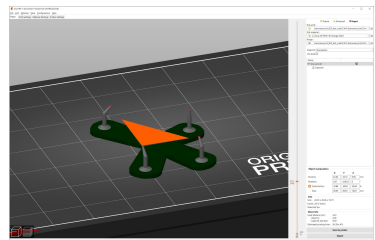

Part of an object starting mid-air. PrusaSlicer can recognize these issues almost every time - these errors usually appear if you manually delete an important support point. You can fix it by re-generating the supports or by adding support points manually.

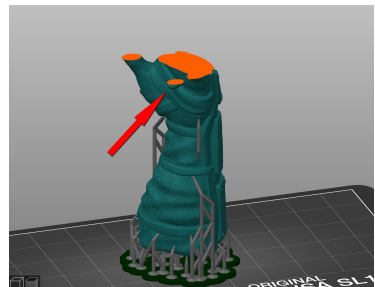

6.13. Printing large and heavy objects

When printing large and heavy objects, you may find out that the standard supports are not strong enough to support the weight of a large object.

There are two ways how to deal with large and heavy objects:

1. **Change the settings for supports**, make them thicker and sturdier
2. **Hollow the object in PrusaSlicer** - see the next chapter

You can easily modify the support parameters by opening the Print Settings tab in PrusaSlicer and selecting Supports. There are three values you should try modifying:

1. **Support pillar diameter** - changes the diameter of supports
2. **Support head front diameter** - changes the size of the support head
3. **Support head penetration** - changes how far into the model will the support head go



If you're trying to print a very large objects and it has a tendency to detach from the platform during the print, try changing the Print profile before you start printing again. Select the project from the file browser and go to Print Settings. Change the Print profile to the slower option - the tilt will be slightly slower resulting in a lesser pulling force on the object.

6.14. Hollowing objects in PrusaSlicer

All objects sliced for the SLA printers are completely solid by default. There is no infill pattern like in FFF/FDM 3D printing. Solid objects printed from the liquid resin can be heavy and robust, but the resin consumption is high compared to hollow objects, especially when printing large models.

Hollowing out your 3D model is a great way to:

- save a considerable amount of material (lowers the print price)
- lower the surface area of each layer - which decreases the force needed to detach the print from the display when moving to the next layer
- reduce the number of needed supports (lower weight of printed model)

We suggest adding at least two drainage holes. Without them, the uncured resin would end up being trapped inside your finished print. However, be careful: printing a hollowed object can create a suction effect, which makes the object more difficult to detach from the bottom of the tank. This is why it is vital to have a correctly positioned drainage hole - it also serves to negate the suction effect.



You need PrusaSlicer 2.2 or newer to access the Hollowing tool.

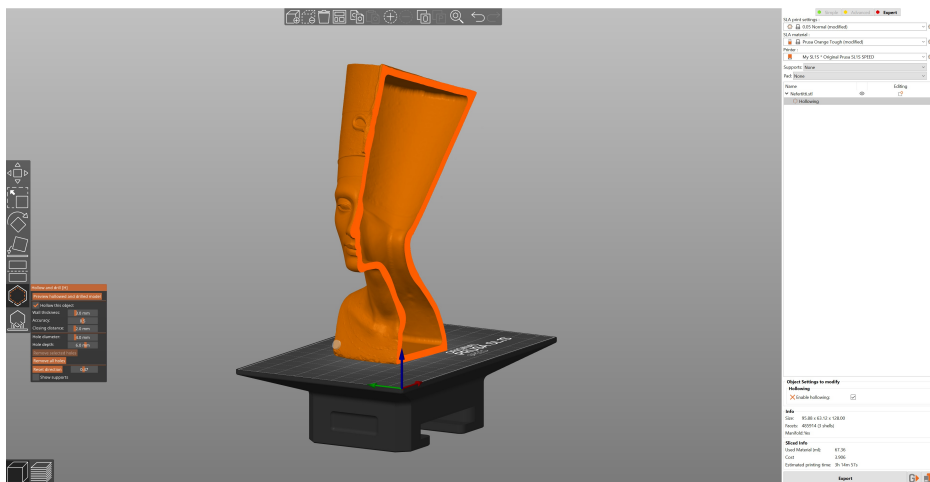

Hollowing can be configured for each model individually using the Hollowing tool in the left toolbar. Alternatively, you can configure hollowing for all models at once in *Print Settings - Hollowing*.



The hollowing and drainage hole workflow is non-destructive. Hollowing can be canceled and drainage holes can be moved or removed at any time.

Hollowing thickness - The thickness of the resulting shell. The minimum value is 1 mm.

Hollowing accuracy - A trade-off between accuracy and performance. If a low hollowing accuracy is set, the resulting model wall thickness may be uneven. Therefore a higher hollowing accuracy is recommended for a small hollowing thickness (for thin shells) to ensure minimum wall thickness.

Hollowing closing distance -Hollowing suppresses cavities narrower than the closing distance threshold, and it also fills in sharp concave corners of the inner wall, from which it would otherwise be difficult to remove the uncured highly viscous resin.

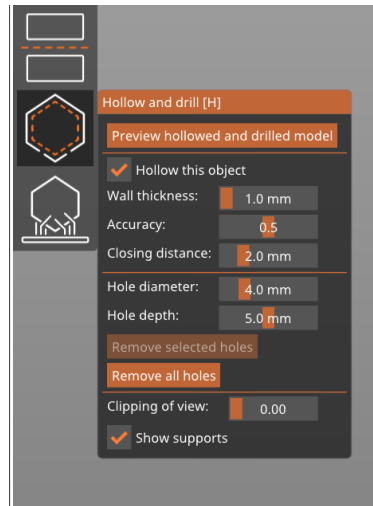

Adding drainage holes - Drainage holes can be added by left-clicking on the object when the SLA hollowing gizmo is active. The holes can later be repositioned by dragging them on the mesh. You can remove holes by right-clicking on any of them.

Each hole is always perpendicular to the surface and its diameter and depth can be configured - the current settings will be used for newly placed holes.



If the input mesh is broken, the hole drilling algorithm may refuse to proceed in order to prevent program crashes or incorrect results.

Confirm and preview the hollowed mesh - The hollowing and hole-drilling are performed after the Preview hollowed and drilled model button is pressed. Note that both hollowing and hole-drilling are computationally expensive tasks and will take some time, especially with complex models. In case the user does not press the button himself, the hollowing and drilling will be performed during the slicing process.

The **Clipping plane tool** can be used to peek inside an object (the same tool is present in the SLA support points editing gizmo). Move the slider from left to right to move the clipping plane. You can review the hollowed geometry and place the drainage holes appropriately.

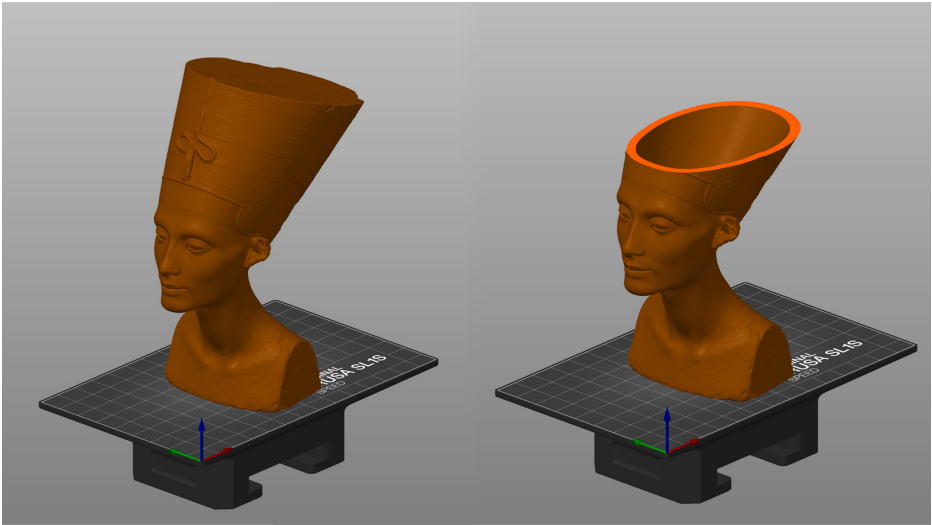

Solid model: 237 ml of resin, \$13.75 resin costs (left). HOLLOWED model: 81 ml, \$4.70 resin costs (right)

7. Connecting PrusaSlicer to the SL1S over the network

PrusaSlicer can be connected to the SL1S 3D printer directly, either via **ethernet or Wi-Fi connection**, enabling you to send sliced models into the printer's internal storage over the network.

Open PrusaSlicer and look at the **right-side menu with the Printer drop-down menu**. Expand the list and pick the last item (Add/Remove Printers), then select **Add Physical Printer**. This will open a new window allowing you to **select your network-enabled SL1S**. Press Browse to scan the local network and select your printer from the list. If the printer is not detected automatically, you can enter its IP address manually (in your printer, go to *Main Menu - Settings - Network* to display the IP address. Alternatively, tap the network icon in the top menu). Next, you need to set the login credentials. There are two ways how to complete this step:

1. By default, the printer has HTTPS Digest enabled for increased security. We recommend leaving HTTP Digest on. You can adjust this option by going into Main Menu - Settings - Network - Login Credentials and turning the HTTPS Digest on or off. If you decide to use HTTP Digest, the only thing you can change in the Login Credentials screen is the password. Take a note of the username and password. Then, go to PrusaSlicer, set Authorization Type to HTTP Digest and enter the username and password. Then confirm your selection by pressing OK.
2. You have the option to disable the HTTPS Digest (not recommended for security purposes!) and use a password only. Go to Main Menu - Settings - Network - Login Credentials and turn HTTP Digest off. Take note of the password. Go to PrusaSlicer, change the Authorization Type to API key and enter the password. Confirm by pressing OK.

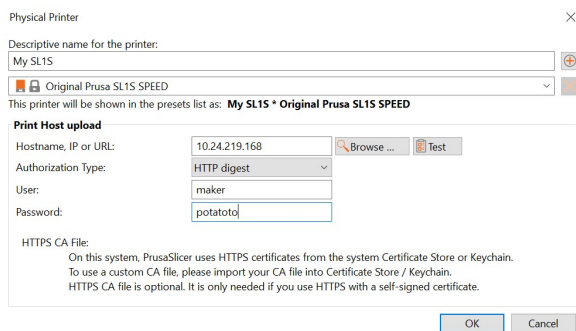
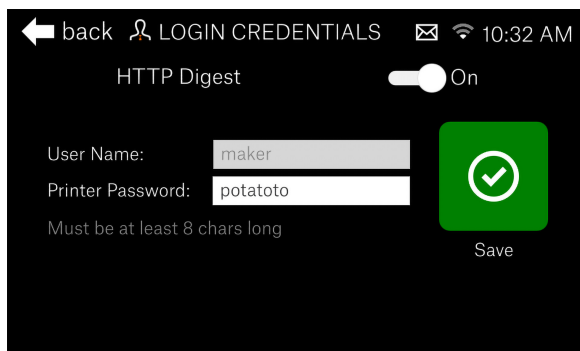

Go back to PrusaSlicer's main window with the 3D view. Import an object and slice it as usual. You should see a **new button in the lower right corner of the screen** that says "Send to printer" when you hover the mouse cursor over it. Click this button to **send the file over network to your printer**. You will receive a notification on the printer's screen and the object will appear in the file browser (*Main Menu - Print - Local*)



Warning! We strongly suggest not to leave the printer unattended. Always prepare the printer for the next print according to the instructions in this handbook. The purpose of this function is to eliminate the need for a USB stick and improve the convenience of use. It is not possible to start the print remotely.

8. Updating the printer's firmware

We recommend keeping the printer updated at all times. Updated firmware packages bring various benefits, such as new features, bug fixes and various improvements. There are two ways to update the printer's firmware:

OTA firmware update

OTA (Over The Air) firmware updates are **delivered via ethernet or Wi-fi network**. Connect the printer to the internet as described in the chapter 4.4 Network connection. If a new firmware is released, the printer will display a notification.

USB firmware update

If your printer is not connected to the internet, you can **download the firmware file from the official website** <https://www.prusa3d.com/drivers>. Download the ZIP file to your computer, unpack it and place the update file (with .raucb extension) on a **FAT32-formatted USB drive**. Then insert the USB drive in the printer's USB slot. Then go to *Settings - Firmware* and select the firmware file from the list.



WARNING! Never turn off or reset the printer during the firmware flashing process!

9. About resins

Liquid resins are **photosensitive materials** used for printing on SLA 3D printers. Resins are also known as photopolymers and they are **cured (solidified) by UV light** - this also includes sunlight. Compared to filaments for FFF/FDM printers, the major difference is that there are not various materials such as PLA, PETG or ASA. There's just THE resin, a base material that can be further enhanced with **added colors or additives**. Typical effects of additives would be increased hardness or toughness of the printed object.



The Original Prusa SL1S 3D printer is compatible with 405nm resins.

Resins usually consist of three basic components:

- **The core** of the resin (monomers and oligomers)
- **Photoinitiators** - molecules reacting to UV light, which initiate the solidifying process
- **Additives** - admixtures that change the color and properties of the resin



9.1. Important information about resins

There are a couple of things to keep in mind when working with resins:

- **Wear gloves** to avoid direct contact of the resin with your skin
- A simple **respirator** is recommended
- **Keep out of the reach of children and pets**
- **Shake the bottle well** before every use for around 10 seconds (make sure the lid is securely tightened before doing so)
- **Wash with water and soap** in case the resin gets in contact with skin/eyes
- If you experience itching or any kind of discomfort after skin contact, **seek out medical assistance**
- **Keep away from light**, store in opaque bottles
- **Keep at room temperature** (18°-32°C), lower temperature changes the viscosity of the resin
- Do not store in dusty areas
- Resin produces fumes - **keep the room ventilated** during printing
- **Some people may be allergic to resins** - in case you experience any kind of discomfort (itching, rash), stop using the machine and contact a doctor



Do not throw resin bottles (empty or full) into regular waste.

Liquid resins should be treated as dangerous chemicals and you should follow your country's laws about disposing of dangerous chemicals. There are usually special containers (e.g. oily waste cans) available for public located near gas stations etc.

9.2. Which resins to buy?

Once you start looking for resins to purchase, always check the **wavelength of the resin** - it determines at which wavelength the solidifying process starts. The Original Prusa SL1S printer is **calibrated for 405nm resins** and has no brand restrictions. Since it's an open-source machine, you can choose any brand of resin you like, as long as it is compatible with the 405nm wavelength. However, always **use recommended exposure times** for the resin of your choice - extremely incompatible times may even lead to a damage to your printer (e.g. setting 40 second curing time for a resin that solidifies in 2 seconds).



Please note that resins with long exposure times also require longer exposure times during post-processing (e.g. in the Curing and Washing Machine)!

Resins should be **stored in their original containers and properly sealed**, ideally in a dark room with a stable temperature. If the original container is damaged, use a non-transparent plastic bottle and the bundled funnel that came with the printer to pour the resin in it. Never store resin in bottles from drinks - if you have to, label it clearly. Do not store resins in cold places as it may lead to gelation of the resin.

9.3. Custom resin calibration

We are continuously testing and growing the number of supported resins for the SL1S printer which also features an **option for experienced users**, who are using special resins and would like to tune their settings.



Part of the "examples for the download" is a **new file for resin calibration**. If a user selects this file for a print, the system recognizes it and starts the resin calibration procedure. The calibration object will be printed eight times with different exposure times (set by the user) allowing to evaluate the print results and select the exposure time, which brings the best result for a given resin. Please refer to the **SL1S Resin Calibration Object** guide available at help.prusa3d.com.

10. Software/driver package

We provide owners of Original Prusa printers with a **bundle of useful programs and tools called Drivers & Apps package**, which can be downloaded from <https://www.prusa3d.com/drivers>

This package contains (among other things) the latest stable version of PrusaSlicer and also a bundle of sample models, which can be used to test the print quality of your 3D printer.

You can also obtain alpha and beta builds of PrusaSlicer from our official Github, located at <http://www.github.com/prusa3d>

11. Controlling the printer via a web browser

You can control the Original Prusa SL1S 3D printer **through a web browser** - even on mobile phones (on local network) via a network interface called Prusa Link. Prusa Link allows you to upload print files, start prints remotely and check the printer's status during the print.

1. Connect the printer to your network as described in chapter **4.4 Network connection**
2. Check the printer's IP address and username/password. See chapter **7 Connecting Slicer to SL1S** over a network for information on obtaining the IP address and username/password.
3. Open a **web browser** of your choice, enter the printer's IP address

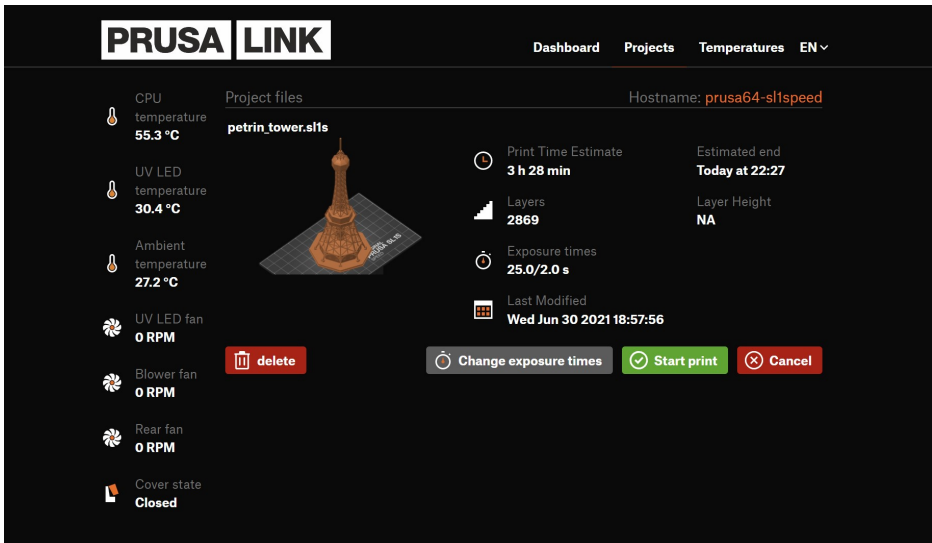

The screenshot displays the Prusa Link web interface. At the top, the 'PRUSA LINK' logo is on the left, and navigation tabs for 'Dashboard', 'Projects', 'Temperatures', and 'EN' are on the right. The main content area is divided into several sections:

- Temperature Gauges:** On the left, there are five vertical gauges: CPU temperature (55.3 °C), UV LED temperature (30.4 °C), Ambient temperature (27.2 °C), UV LED fan (0 RPM), Blower fan (0 RPM), Rear fan (0 RPM), and Cover state (Closed).
- Project Files:** A central section titled 'Project files' shows a 3D model of a tower and the filename 'petrin_tower.sls'. Below the model is a red 'delete' button.
- Print Information:** On the right, it displays 'Hostname: prusa64-sl1speed', 'Print Time Estimate: 3 h 28 min', 'Estimated end: Today at 22:27', 'Layers: 2869', 'Layer Height: NA', 'Exposure times: 25.0/2.0 s', and 'Last Modified: Wed Jun 30 2021 18:57:56'.
- Control Buttons:** At the bottom, there are three buttons: 'Change exposure times' (with a gear icon), 'Start print' (with a green checkmark icon), and 'Cancel' (with a red X icon).

12. Optional Accessories

There's a couple of things you might want to consider buying to make your 3D printing experience better, safer and more convenient.

12.1. Original Prusa Curing and Washing Machine - CW1S

Objects printed from liquid resin are usually a bit soft and sticky. To clean them and reach optimal surface properties, the **objects need to be washed, dried and cured**. This process involves **washing the object in isopropyl alcohol, drying using hot air and curing using UV light** - see chapter *5.1 Drying and Curing Printed Objects*.

To make this process much faster, simpler and more convenient, we have designed a **4-in-1 device called Curing and Washing Machine (CW1 for short)**. This device is sold as an **optional accessory** and it reduces an otherwise rather complicated and potentially messy process into a few minutes. To learn more about this device, visit our e-shop at <https://www.prusa3d.com>.



12.2. FEP Films - Original and Aftermarket

The Original Prusa SL1S comes with a spare **FEP film, which acts as a transparent bottom of the resin tank**. Since this part is a consumable (it will degrade over time by continuous use), you will have to replace it from time to time. Compared to certain other 3D printer brands, **you don't have to replace the whole tank**, you can remove just the film.

You can order a new FEP film from our e-shop at <https://www.prusa3d.com>. The process of replacing the FEP film is described in chapter **14.1 Replacing the FEP film** at the end of this handbook.

Several things to keep in mind regarding FEP films:

- **The FEP film we're using is not proprietary** - you are free to buy FEP films from online or retail stores.
- **The FEP film is a consumable** - it means the quality of the surface will slowly degrade through continuous use. However, we wanted the part to be easy to replace and inexpensive. You can buy a replacement FEP film on our e-shop.
- **You should be extremely careful when handling the tank.** Keep it away from sharp objects that could potentially damage the bottom of the tank. FEP films that were pierced, scratched or damaged by improper use are not subject to warranty terms.

You can, of course, **use a FEP film from your own source**. However, keep in mind that the **thickness of the film affects the quality of the print** and that the FEP films from our shop have the correct size and holes for screws. Thicker films disperse light more, so the printed object may lose some details. Very thin FEP films are, however, prone to damage.



Never use the bundled metal spatula to remove stuck objects from the FEP film. Do not use fingernails, screwdrivers or other sharp objects to remove stuck objects from the FEP film! You can clean the FEP film with isopropyl alcohol, alternatively use a combination of warm water and a dishwashing product.



12.3. Additional accessories

Optional accessories you should consider buying:

- **Paper towels** - for cleaning up the printer, drying printed models...
- **Isopropyl alcohol** - for cleaning the prints
- **Plastic tablecloth** - to contain resin spillage and to make cleaning up easier
- **Pipette** - for removing larger resin drops/stains
- **Respirator / protective glasses**

13. Regular Printer Maintenance

Although the Original Prusa SL1S has a number of smart sensors and has been carefully designed to be easy to use, it's still a machine and **requires regular maintenance and care**. There are several key areas that require attention if you want to keep your printer in good shape for a long time.

13.1. Keeping the printer clean

The key to a trouble-free experience is first and foremost **keeping the printer clean**. Resins are liquids and they are easily spilled. Every time you use the printer, make sure you are **not leaving drops or stains of liquid anywhere**. Liquid resin will solidify even in regular daylight, making it much more difficult to remove compared to its liquid form.

When removing the print platform / printed objects, make sure to shield the printer from drops of resin. **Always keep a bundle of soft paper towels near the printer, so you can wipe any spilled resin/resin drops immediately**. To clean drops of resin more effectively, use a piece of cloth / paper towel dipped in isopropyl alcohol. For more delicate surfaces (such as the display), use a mix of water and dishwashing product.

A good practice is to **place a plastic table-cloth under the printer** for easier cleaning. However, be careful - the table-cloth **must not block the fan** on the underside of the printer.



Do not use acetone, IPA or ethanol to clean the lid!

The lid is made of acrylic glass and it has a special surface finish to block UV light from reaching the printing chamber. You can clean it with standard products for cleaning glass. Do not use acetone, IPA or technical alcohol - it would damage the acrylic glass.

13.2. FEP film / Tank maintenance

It's a good practice to empty the resin tank after each print - there might be tiny solidified resin particles you might not see - these could potentially damage the FEP film when starting the next print. Use a funnel to pour the resin out of the tank into a bottle. Don't mix used resin with unused liquid. Instead, use a new bottle.

Inspect the resin tank bottom before and after each print. Look for any scratches, dents or holes. If the FEP film is damaged, replace it immediately, otherwise, you're risking a resin spillage.

If the FEP film has a grey-ish tint, you can restore it to its original look by washing it with warm water with a bit of dishwashing soap (or even regular soap) before you start printing again. Don't print with a dirty or damaged FEP film, as it will negatively impact the print quality. It may even lead to damage to your printer.

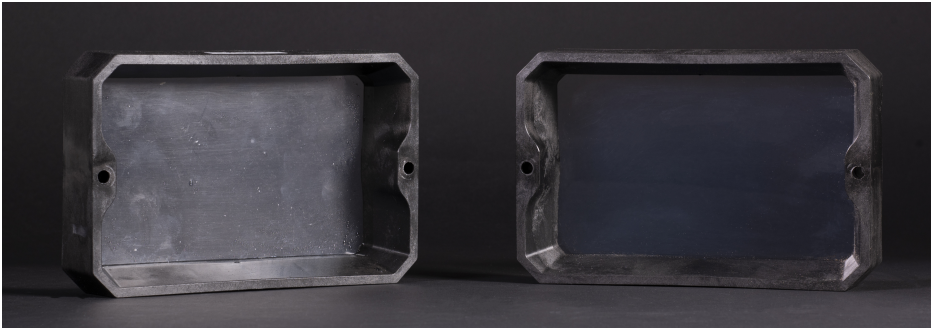

Visit our Knowledge Base at <https://help.prusa3d.com> to learn how to replace the FEP film.

13.3. Tank and FEP film cleaning

Any cured bit of resin left in the tank after a print can cause failed prints (holes, missing geometry) and even damage to the print display. Firmware version 1.7.0 introduces the feature of cleaning the resin vat for cured bits or other debris left behind at the bottom of it.

How it works is that a single layer of the entire build space is cured simultaneously, capturing any solid bits that may have sunk to the bottom of the resin vat. This is then easily removed using a cleaning adaptor placed into the tank prior to running the cleaning procedure.

We recommend running the cleaning procedure before each print unless you have just changed the resin and cleaned the tank by hand.

Starting with firmware 1.7.0, we're introducing a new function called Resin Tank Cleaning and a special adaptor that you can download from [Printables.com](https://www.printables.com) and print it. The function can be found in LCD Menu - Control - Resin Tank Cleaning.



The resin tank cleaning procedure is described in a step-by-step guide in our online Knowledge Base. Please visit <https://prusa.io/sl1s-resin-tank-cleaning> or scan the QR code on the left to view the detailed guide.

13.4. Print platform maintenance

The platform should be cleaned thoroughly after every print - usually, there will be some leftover resin on the platform. Use paper towels or a spatula to wipe the top of the platform clean, then proceed to remove the platform and the printed object.

Once the object is removed, **use isopropyl alcohol and paper towels to clean the print platform thoroughly**. Leaving liquid resin on the platform for extended periods of time can lead to solidifying of the material.

After removing an object, use a metal spatula to scrape any remnants of the previous print and use paper towels to wipe the underside of the print platform clean - make sure that the print platform is nice and shiny before you start the next print. Any leftovers on the platform (leftover supports, pads) could potentially damage the bottom of the resin tank or even the display. Surface scratches on the print platform won't affect the quality of the print.



After you clean the print platform with isopropyl alcohol, dry it thoroughly!

13.5. Exposure screen maintenance

Use a damp cloth or LCD cleaning spray to keep the glass / LCD display clean. Don't use any rough materials (sanding paper) or low-quality paper towels, otherwise, you might scratch the surface. **Make sure that the print display is clean before you start a print** and that there are no smudges, stains, scratches or cracks.



Do not use sharp objects, such as metal spatulas, knives, flat screwdrivers and similar tools to remove dirt or resin from the protective glass. Instead, use IPA or dishwashing products in combination with soft paper towels to avoid scratching the display.

13.6. Acrylic lid

The lid has three major functions: it protects the printed model from potential damage, helps to contain resin fumes inside the box and **blocks a significant amount of UV light** so it doesn't reach the printing chamber. Especially the last part is important - if you leave the resin in the tank

and keep the lid open, **it can start to solidify quickly** depending on the environment.



The lid won't stop 100% of UV light - do not place the 3D printer next to a window, otherwise the sunlight might cure the resin in the tank.

This also means that **you shouldn't disable the cover check**. It may be tempting to watch the print process, but for the sake of better results and safer operation, keep the lid closed during the print. You can, of course, open it for a quick check and then close it again.

Don't run the printer with the lower case panels removed or with any parts missing. The case helps to contain the UV light.

You can wash the lid with window cleaners. **Do not wash it with IPA, acetone or ethano!** Do not use rough materials to clean the lid (e.g. sanding paper, rough sponges).

13.7. UV light and potential health risks

Eyes are very sensitive to UV light and UV radiation, because the cornea absorbs high amounts of UV light. Extended exposure to strong UV light may lead to corneal damage, macular degeneration or cataracts - these conditions can ultimately lead to blindness.

This is why the Original Prusa SL1S is designed to contain the UV light inside, which means that when used according to the instructions in the manual, there are no health risks related to UV radiation during regular use.



DO NOT LOOK DIRECTLY INTO THE UV LIGHT AND DO NOT PRINT WITH THE BODY COVER REMOVED! If you want to check the UV led panel, look at it through your phone camera app or take a photo, so you won't look directly into the UV light.

13.8. Fan cleaning / Removing dust

It's a good practice to **clean the fans from time to time**, especially if you have pets at home - the recommended time period will vary depending on the environment, in which the SL1S is used. In general, it's good to **inspect the printer every 6-8 weeks**. There are three fans placed inside the printer. You can get to the side fan and bottom fan by removing the main body cover.

First, **turn off the printer** and disconnect it from the power source. Locate eight screws on the sides of the printer (four on each side) and remove them with an Allen key. Then carefully slide the body cover out. **Be careful not to damage any cables which are attached to the power button**. This will give you better access to two fans. Use a can of compressed air to clean the fans carefully.

The third fan is located on the backside of the printer. Locate two screws holding a small door closed and remove them. Open the door and use a can of compressed air to clean the fan.



Never blow compressed air on running fans!

Dust can also accumulate on the underside of the display and on the reflector. You can clean these parts carefully with compressed air. First, unscrew the eight screws holding the display in place, then **slowly and carefully remove the display** - be careful not to damage the display's wires. Use compressed air from the distance of about 30 cm to clean out the dust particles gently. **Do not use sharp or rough objects!**

13.9. Carbon filter replacement

Check the carbon filter from time to time to ensure it is in good shape. **The carbon filter is located on the back side of the printer under a small door.** Use an Allen key to remove two screws holding the door shut. Open the door and remove the filter. Check if it is in good shape, and consider replacing it if it isn't.

13.10. Tower maintenance

The tower (Z-axis consisting of the trapezoidal rod and the cantilever) requires little to no regular maintenance. In case the printer starts making unwanted noises when lifting or raising the platform, **consider applying a lubricant** on the trapezoidal rod - any good super lube will do the trick.

13.11. Tilt maintenance

The key to a long-lasting and smoothly running tilt bed is simple: **keep it as clean as possible.** Consider buying a protective plastic tray (optional accessory) every time you manipulate with the resin or the print platform with the finished print. The tray will stop the resin from spilling over the tilt bed.

14. Hardware troubleshooting

Please note that detailed hardware troubleshooting articles will be available only online at <https://help.prusa3d.com>.

14.1. FEP film / Tank bottom replacement

The FEP film that serves as the bottom of the resin tank **is a consumable**. This means its quality will decrease over time - this is intended behaviour. The FEP films used in the SL1S are non-proprietary, which means you can purchase the material anywhere you want. The only thing you need is to prepare a template for the screw holes, which you can download from our Original-Prusa-SL1 project at github.com/prusa3d. You can, of course, **buy ready-made FEP films from our e-shop**.

The process of replacing a damaged FEP film is described in our Knowledge base at <https://help.prusa3d.com>.



An extreme case of FEP film damage



If you replace the FEP film, re-calibrate the printer!

14.2. Replacing the print screen

The print (exposure) display is a consumable and it will degrade over time. **When you start noticing visible artifacts on your prints** (e.g. missing parts, randomly cured resin in various parts of the tank), it is usually time to **replace the LCD module**. Before you do that, make sure to **go through the troubleshooting steps** described in this handbook to ensure that the issues are not

caused by something else (e.g. dirty FEP foil, incorrectly calibrated printer etc.). You can order a new exposure display from our e-shop at <https://www.prusa3d.com> - make sure you are logged in, so you can see the **Spare parts section**.

Once you receive the new display please follow the guide at [help.prusa3d.com](https://www.prusa3d.com) (Original Prusa SL1S - Using the Printer - How to replace the print display) to learn how to replace the exposure display correctly.

14.3. Spilled resin

Always exercise caution when handling liquid resins. If you manage to spill resin inside the printer (e.g. through the tilt bed), **turn off the printer immediately and disconnect the power cord.**

Locate eight screws on the body cover (four on each side of the printer), remove them and take off the metal body cover. Inspect the damage: in case there's just a few drops of resin, it's very likely that they've been caught by the tilt bed assembly. Wipe them clean and make sure there are no leftover drops anywhere. Put the cover back and check whether everything works fine.

In case there's a major spillage (e.g. on the mainboard), keep the printer turned off and contact our tech support.

15. Print quality troubleshooting

When you print on SLA printers, you may encounter several print quality issues. The following section will help you recognize them and solve them.

15.1. Removing an object stuck to the bottom of the tank

In case the first layer did not stick to the print platform, it remained **stuck at the bottom of the tank**. No matter how big or how small the stuck layer is, there's a quick safe way that will help you remove it from the FEP film without damaging it:

1. Unscrew the resin tank screws and remove the tank
2. Take an empty bottle and insert the bundled funnel/filter in it
3. One of the tank corners has a different shape, use it to pour the resin from the tank into the bottle. Always pour used resin into a new bottle; don't mix it with unused liquid - especially if the print failed.
4. Wipe the tank with a soft paper cloth. The layer that got stuck should be now fully visible
5. Keep the tank in a horizontal position and **use your fingertips to press from the underside of the FEP film against the stuck layer**. This will detach the solidified layer from the bottom. Use a reasonable amount of force and don't use your fingernails. If the layer is larger, start from the edges and use a circular motion to detach it evenly. You will usually hear the sound of the layer detaching from the FEP film - this indicates that it's working.

Once the stuck object is removed, clean the printer and the tank and try printing a sample object. If the print fails again, **re-run the calibration process**. The most likely cause of this issue is an incorrect Z-offset of the print platform.

15.2. First layer doesn't stick (Non-Adherence)

If you notice during the printing process that no object appeared on the print platform, it usually means that **the first layer didn't adhere properly**, or the object detached mid-print. To rule out slicing-related issues, try printing a sample (pre-sliced) object first.

There are a number of reasons why the first layer does not stick to the print platform:

a) The print platform is not secured properly

The print platform is not properly secured. Make sure that you didn't forget to **tighten the black knob at the top of the tower**. A freely moving print platform cannot reach an optimal position and the first layer won't stick.

Solution: Tighten the black knob at the top of the platform.

b) The bottom of the tank is cloudy/dirty

Before you pour the resin into the tank, make sure that the bottom of the tank (the FEP film) is completely clear. **A cloudy, dirty or damaged FEP film will have a negative impact on the printing quality** and it may even block UV light enough to stop the resin from solidifying properly.

Solution: Clean the FEP film using warm water and a bit of dishwashing product, and wipe it with soft paper towels. Low quality / rough paper towels could scratch the surface.

c) Incorrect slicing settings

There's a couple of things that may go wrong during slicing - incorrect exposure times, an incorrect object orientation or a lack of supports.

Make sure that you are using the **recommended exposure times** for the resin of your choice. We have tested over a hundred of various resins and we're constantly testing new ones, so we can add tweaked resin profiles into PrusaSlicer.

Solution: Reslice your model using default settings and try printing the object again, or try printing one of the sample objects to rule out the possibility that slicing settings are the cause. The exposure times for initial layers should be much longer - e.g. 25 seconds to ensure a strong connection to the print platform.

d) Poor object orientation / insufficient supports

Incorrect object orientation can be another source of issues with adhesion. After a layer is solidified, the printer has to detach it from the bottom of the tank - if there's a single support holding a large part of the object, it won't withstand the peel force, causing it to detach.

Solution: Please refer to the chapter Slicing - Best practices to learn how to position an object correctly.

e) Resin has been mixed with IPA

The resin has been mixed with IPA (e.g. while cleaning the print platform) and its properties have changed, causing it to not solidify.

Solution: Clean the resin tank properly, use a new batch of resin and try again.

f) The printer is not calibrated correctly

It's possible that something changed since the last calibration of the printer - you have replaced some parts or moved the printer to a new location.

Solution: A re-calibration is required. Please refer to the **4.5 Calibration chapter** for step-by-step instructions.

g) A faulty print display or UV LED panel

If the first layer didn't adhere to the print platform and it's not attached to the bottom of the tank either, it usually means that **the first layer wasn't created at all**. A possible cause is a faulty print display or a faulty or disconnected UV LED panel.

Solution: Please refer to the online troubleshooting section at <https://help.prusa3d.com> to learn more about diagnosing the function of these two parts.

15.3. Printed object has missing parts

In some cases, **a print can finish even if some parts of the object weren't fully printed**, but a missing part of an object will more often cause the whole print job to fail. Try printing a sample object to see whether it is also affected by this issue.



The warrior's right arm is missing completely and a part of the shield is damaged

There are **two main reasons** (and a third, less common one) why printed objects have missing parts and they both usually come down to incorrect slicing settings:

a) Lack of supports

Please check the **6.5 Slicing objects for the SL1S** chapter to learn how to correctly position an object and generate supports for it. Keep in mind that **parts of the object cannot start mid-air** and that the printer has a threshold for overhangs.

Solution: Improve the supports in PrusaSlicer, re-slice the object and try printing it again. If the problem persists, **try printing a sample object** and see if the problem is still present. If it is, there might be a problem with the printing display or UV LED panel. See online troubleshooting at <https://help.prusa3d.com> to learn more.

b) Incorrect exposure times

If you set **incorrect exposure times** (especially too low times), the resin will not have enough time solidify, which may result in missing details. Always make sure you're using recommended exposure times for your prints.

Solution: Make sure you are using exposure times recommended for the resin of your choice.

c) Faulty hardware

Another possibility (a less common one) is that your **print display or UV LED panel is faulty**, so either the mask is incorrectly displayed or only a part of the object is cured by UV light. Please refer to the Hardware troubleshooting section at <https://help.prusa3d.com> to learn how to diagnose the print display and UV LED panel.

15.4. Printed object is missing small details

The Original Prusa SL1S 3D printer can produce objects with an incredible amount of details - tiny wrinkles on clothes of a figure, structure of a skin, thin railings on buildings... however, in case the printed object is missing incredibly tiny details (not entire parts of the model), it can be due to incorrect exposure times.

a) Insufficient exposure

Too short exposure times will result in details being "melted" together. **Increase the exposure times** to recommended values to fix this issue.

b) Overexposed layers

Long exposure times will result in a "staircase" effect - the layers won't blend into each other perfectly and some details may be lost due to this effect. **Use recommended exposure time values** to fix this issue.

15.5. Printed object detached from supports

If the printed object detaches from supports mid-print, it usually falls into the resin tank, while the supports are still attached to the print platform. It's usually caused by **a combination of the printed object's weight and insufficient supports**. Another possibility is that you are printing a hollow object without drainage holes - this creates suction on the bottom of the tank and the object cannot detach properly.

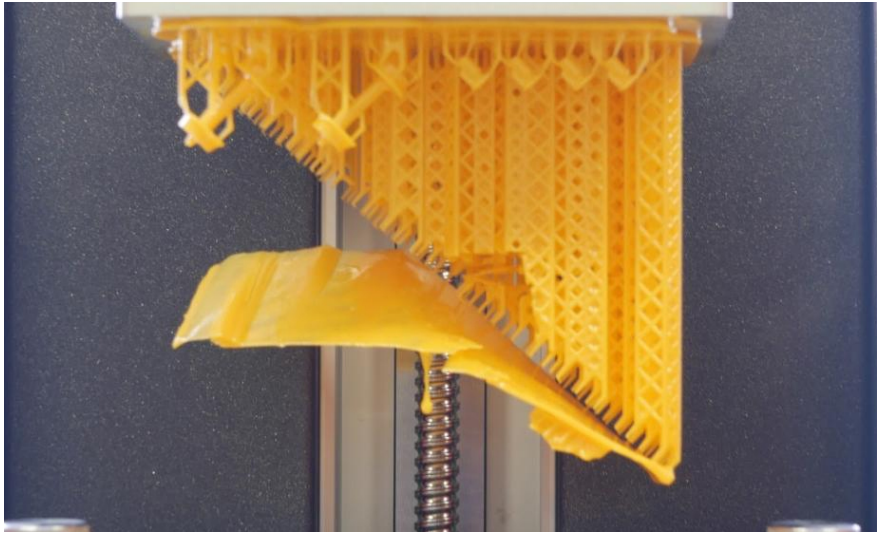

Consider using PrusaSlicer to hollow out the object. Too heavy (solid) objects may be too much for default supports and as a result, they often detach from supports once they reach a certain weight threshold.

Solution: Increase the number of supports or the thickness of supports. Check the exposure times and change them to recommended values. Use a slower print profile - when you select the object to print in your SL1S file browser, you can then open the Print Settings menu and switch the Print profile to the slower (safer) option.

15.6. Broken supports

Broken supports (or missing parts of supports) are usually caused by **incorrect settings in PrusaSlicer** - the supports are either too thin or the exposure time is set to too low value. In some cases, this can be also caused by a faulty UV LED panel or dirty FEP film.



Solution: Try printing one of the sample objects to see whether the issue remains. If the sample object was printed without trouble, reset your PrusaSlicer settings. If the sample object has the same sort of trouble, inspect the FEP film in the resin tank - it may be dirty. In very rare scenarios, a faulty UV LED panel can be the cause.

15.7. Printed object is skewed / deformed

A skewed/deformed print is **usually caused by loose screws** - either the large black knob at the top of the cantilever, or the resin tank screws are not properly tightened.

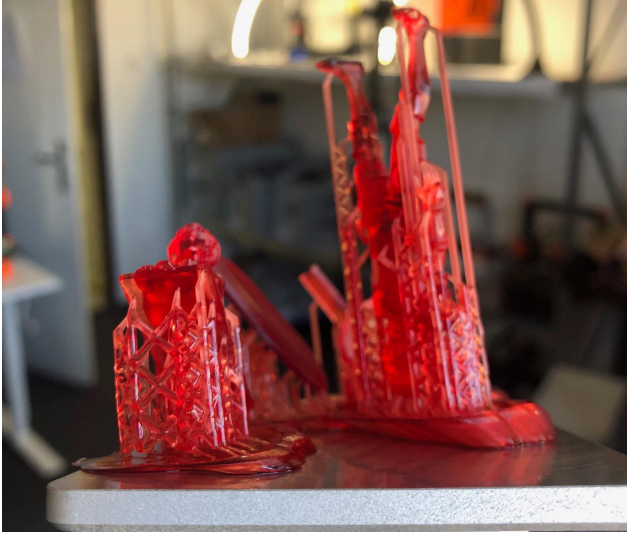

Solution: Make sure the printer is properly calibrated, tighten the black knob at the top of the tower and tighten both resin tank screws evenly and with the same amount of force.

15.8. Print doesn't appear / resin does not solidify

If the print **does not appear on the print platform, nor at the bottom of the resin tank**, there are a couple of possible causes: insufficient exposure times, faulty UV panel, faulty LCD screen, or there's too much isopropyl alcohol in the resin.

Solution: First try a new batch of resin. If you kept re-using one batch several times, it's possible the resin lost its original properties and won't solidify anymore. Check the UV panel and LCD screen, whether they work as intended - run the printer's self-test and calibration to make sure the hardware is not faulty.

15.9. Printed object has very visible layers

Even though SLA printers can achieve much better resolution than standard FFF/FDM 3D printers, layers on objects can be still visible if you look very closely. If you feel like the layers on

your prints are too visible, there's a couple of things you can try.



Solution: Print a sample object with a good/tested resin (like the sample bottle of Prusa Orange) and see if the issue is still present. If it's not, then the cause is usually related to slicing settings. Try rotating the object to eliminate gradually rising / declining surfaces. Extreme exposure times can also produce visible layers. Mixed / low quality resins can also affect the print quality - use a fresh, high-quality resin and shake the bottle for at least 20 seconds before you pour the resin in the tank.

15.10. Delamination / Separated layers

If you encounter delamination, separated layers or missing layers, the cause is usually in a broken SL1S / STL file - it's a different case than a lack of supports. Another cause can be a faulty UV LED panel or dirt in the resin tank.

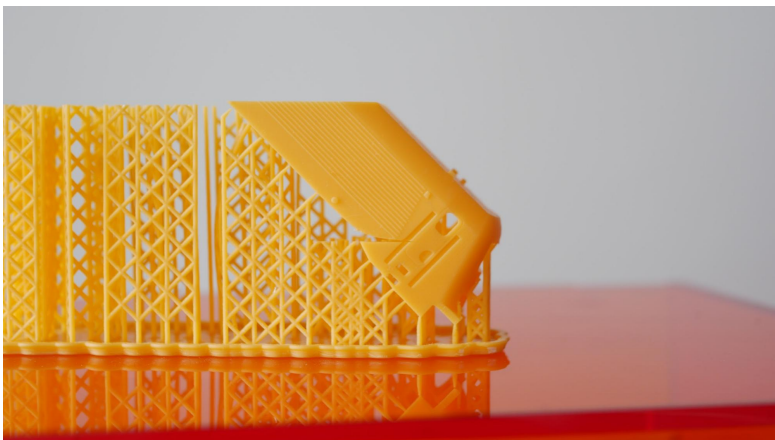

Solution: Try printing a sample object and see if the issue persists. If it does, clean the resin tank properly and try again. Continuous issues with separated / missing layers can be caused by a faulty UV LED panel - check whether it works correctly. Otherwise, the cause is most likely a broken object file. Either try re-slicing the model or download a new one.

15.11. Warped layers

Most resins have a tendency to **expand by several micrometers** after they are cured. These expansions and resulting forces can lead to layer warping and layer separation. However, these errors are usually limited to large solid layers.



Solution: This printing error is caused by the physical properties of resins. Consider hollowing problematic objects, if you encounter layer warping.

15.12. Large holes in printed objects

Solution: Make sure the FEP foil on the bottom of the tank is perfectly clean. Carefully remove any dirt / solidified bits. If the FEP foil is cloudy, use hot water and dishwashing soap to clean it and restore it to the original look.



Solution: Make sure the FEP foil on the bottom of the tank is perfectly clean. Carefully remove any dirt / solidified bits. If the FEP foil is cloudy, use hot water and dishwashing soap to clean it and restore it to the original look.

16. FAQ - Frequently Asked Questions

Q: UV LEDs don't light up

A: If you want to check whether the UV LED panel works correctly, NEVER LOOK DIRECTLY IN THE UV LIGHT! The safe way to check whether the panel works or not is to use your smartphone's camera - either look at the LED panel through your phone's screen or take a picture and inspect the photo. You can also place a sheet of paper onto the exposure display and then run the display check: *Main Menu - Settings - Calibration - Display Test*.

Q: Printer cannot be calibrated - the prints don't stick to the print platform

A: Try printing a sample object. If the print remains stuck to the bottom of the tank, re-run the calibration process. If it doesn't help, try replacing the FEP film.

Q: The printer displays a message related to overheating

A: Make sure the printer is located in a room with ambient temperature between 18-32°C. Check if all fans are spinning and there are no objects that would block the air inlets/outlets. There should be at least 20 cm of free space around the printer, 30 cm is better.

Q: USB is not recognized or 'File is corrupted' error

A: Try to export / copy the SL1S file again. In case the error is still there, try a different USB drive.

Q: Wifi browser does not list my network

A: Please, make sure that your wireless network name does not contain non-standard characters. Try renaming your Wi-Fi network and see if the problem is solved.

Q: I can't connect to unprotected (public) wireless networks

A: Due to security reasons, the printer can be connected only to WPA2-protected networks.

Q: Wifi / LAN does not connect

A: There can be various reasons why the printer won't connect to your network, but since every network is different, it's difficult to pinpoint the exact cause.

- Can you see the list of other wifi networks in the browser?
- Are you sure you are entering the password correctly?
- Can other devices connect to your network?
- Do you have a DHCP service running on your network, so IP addresses are assigned automatically?

Q: Printer doesn't turn on

A: Is the power cord attached firmly? Is the switch on the back side of the printer switched to the "On" position? Try disconnecting the power cord and then reconnecting it after a few seconds.

Q: LCD touch screen does not respond to touch

A: The display uses a capacitive touch screen layer and it might not recognize a touch with wet fingers. Make sure your hands are dry and the display is clean.

Q: Resin vapours are very noticeable

A: Some resins have a more prominent smell than others. Always run the printer in a well-ventilated room. Consider switching to a different brand of resins that promises less noticeable odors when printing. However, it's almost impossible to eliminate resin vapours completely. The SL1S features a rear fan with activated carbon filter with the option to attach a hose adapter (not a part of the package).

Q: The lid of the printer has been left open and the resin started to solidify in the tank

A: In most cases, it's possible to "save" the tank, sometimes even the FEP foil depending on how much has the resin solidified. Remove the tank from the printer, find a large volume container (e.g. a bucket and start removing the resin with a metal spatula carefully. If you damage the FEP film, you can replace it according to the instructions in this handbook.



Printables

by JOSEF PRUSA

**PRINT AND SHARE!
JOIN OUR COMMUNITY!**

Download 3D models for free
at [printables.com](https://www.printables.com) and participate
in design contests!

**Follow us for tips, guides,
inspiring videos and amazing 3D prints!**

Share your prints with

#printedbyprusa

