



HDS100 Series Oscilloscope Meter

User Manual

For product support, visit: www.owon.com.hk/download

※: The illustrations, interface, icons and characters in the user manual may be slightly different from the actual product. Please refer to the actual product.

Aug. 2024 edition V1.0.0

Copyright © LILLIPUT Company. All rights reserved.

The LILLIPUT's products are under the protection of the patent rights, including ones which have already obtained the patent rights and those which are applying for. The information in this manual will replace all materials published.

The information in this manual was correct at the time of printing. However, LILLIPUT will continue to improve products and reserves the rights to change specification at any time without notice.

owon[®] is the registered trademark of the LILLIPUT Company.

Fujian LILLIPUT Optoelectronics Technology Co., Ltd.

No. 19, Heming Road

Lantian Industrial Zone, Zhangzhou 363005 P.R. China

Tel: +86-596-2130430

Fax: +86-596-2109272

Web: www.owon.com

E-mail: info@owon.com.cn

General Warranty

We warrant that the product will be free from defects in materials and workmanship for a period of 1 years from the date of purchase of the product by the original purchaser from our company. This warranty only applies to the original purchaser and is not transferable to a third party.

If the product proves defective during the warranty period, we will either repair the defective product without charge for parts and labour, or will provide a replacement in exchange for the defective product. Parts, modules, and replacement products used by our company for warranty work may be new or reconditioned like new. All replaced parts, modules and products become the property of our company.

In order to obtain service under this warranty, the customer must notify our company of the defect before the expiration of the warranty period. Customer shall be responsible for packaging and shipping the defective product to the designated service centre, a copy of the customers proof of purchase is also required.

This warranty shall not apply to any defect, failure or damage caused by improper use or improper or inadequate maintenance and care.

We shall not be obligated to furnish service under this warranty a) to repair damage resulting from attempts by personnel other than our company representatives to install, repair or service the product; b) to repair damage resulting from improper use or connection to incompatible equipment; c) to repair any damage or malfunction caused by the use of not our supplies; or d) to service a product that has been modified or integrated with other products when the effect of such modification or integration increases the time or difficulty of servicing the product.

Please contact the nearest Sales and Service Offices for services.

Excepting the after-sales services provided in this summary or the applicable warranty statements, we will not offer any guarantee for maintenance declared or hinted, including but not limited to the implied guarantee for marketability and special-purpose acceptability. We should not take any responsibilities for any indirect, special, or consequent damages.

TABLE OF CONTENTS

1.SAFETY INFORMATION	1
General Safety Requirements	1
Measurement Category	3
Safety Terms and Symbols	4
2.QUICK START	5
General Inspection	5
Install the Batteries	5
Adjusting the Tilt Stand	6
Power on/off	6
Selecting the Range	7
Measurement Connections	7
3.INSTRUMENT PANEL	8
Front Panel and Keys	8
Side Panel	10
4.HOW TO USE THE MULTIMETER	11
About This Chapter	11
Instrument Interface	11
Input terminals	13
Making Measurements	13
Measuring AC or DC Voltage	13
Measuring Resistance	14
Measuring Continuity	15
Measuring Diodes	16
Measuring Capacitance	16
Measuring Frequency	17
Measuring DC or AC Current	18
Multimeter Features	19
Setting Scale	19
Setting Range	19
Making MAX/MIN Measurements	20
Making Comparative Measurements	20
Value Hold Mode	21
Making Relative Measurements	22
5.HOW TO USE THE OSCILLOSCOPE	23
Introduction to the User Interface of the Oscilloscope	23
Measuring System	25

Table of Contents

Automatic Measurement	25
Trigger System	26
Save and Recall Picture	28
System Settings	29
6. TECHNICAL SPECIFICATIONS	33
Multimeter Specification	33
Oscilloscope Specification	35
General Specification	35
7. APPENDIX	37
Appendix A: List of Accessories	37
Appendix B: Maintenance and Cleaning	37
General maintenance	37
Charging and Replacement of Battery	38
Replacement of Lithium Battery	38

1. Safety Information

(Be sure to read the safety information before using this product.)

General Safety Requirements

Before any operations, please read the following safety precautions to avoid any possible bodily injury and prevent this product or any other products connected from damage. In order to avoid any contingent danger, this product is only used within the range specified.

- **Limit operation to the specified measurement category, voltage, or amperage ratings.**
- **Do not use the oscilloscope meter if it is damaged.** Before you use the oscilloscope meter, inspect the case. Look for cracks or missing plastic. Pay particular attention to the insulation surrounding the connectors.
- **Do not use the test leads provided for other products.** Use only the certified test leads specified for this product.
- Inspect the test leads for damaged insulation or exposed metal.
- Before use, verify the oscilloscope meter's operation by measuring a known voltage.
- **Only the qualified technicians can implement the maintenance.**
- **Always use the specified battery type.** The power for the oscilloscope meter is supplied with a battery. Observe the correct polarity markings before you insert the batteries to ensure proper insertion of the batteries in the oscilloscope meter.
- **Check all Terminal Ratings.** To avoid fire or shock hazard, check all ratings and markers of this product. Refer to the user's manual for more information about ratings before connecting to the oscilloscope meter.
- Do not operate the oscilloscope meter with the cover or portions of the cover removed or loosened.
- **Use Proper Fuse.** Use only the specified type and rating fuse for the oscilloscope meter.
- **Do not operate if in any doubt.** If you suspect damage occurs to the

oscilloscope meter, have it inspected by qualified service personnel before further operations.

- **Do not operate this product in wet or damp conditions.**
- **Do not operate in an explosive atmosphere.**
- **Keep product surfaces clean and dry.**
- Do not apply more than the rated voltage (as marked on the oscilloscope meter) between terminals, or between terminal and earth ground.
- When measuring current, turn off the circuit power before connecting the oscilloscope meter in the circuit. Remember to place the oscilloscope meter in series with the circuit.
- When servicing the oscilloscope meter, use only the specified replacement parts.
- Use caution when working above 60 V DC, 30 V AC RMS, or 42.4 V peak. Such voltages pose a shock hazard.
- When using the test leads, keep your fingers behind the finger guards on the test leads.
- Remove the test leads from the oscilloscope meter before you open the battery cover.
- To avoid false readings, which may lead to possible electric shock or personal injury, replace the battery as soon as the low battery indicator appears and flashes.
- Disconnect circuit power and discharge all high-voltage capacitors before testing resistance, continuity, diodes, or capacitance.
- **Use the proper terminals, function, and range for your measurements.** When the range of the value to be measured is unknown, set the rotary switch position as the highest range, or choose the auto ranging mode. To avoid damages to the oscilloscope meter, do not exceed the maximum limits of the input values shown in the technical specification tables.
- Connect the common test lead before you connect the live test lead. When you disconnect the leads, disconnect the live test lead first.
- Before changing functions, disconnect the test leads from the circuit under test.

Measurement Category

The oscilloscope meter has a safety rating of 1000 V,CAT III.

Measurement category definition

Measurement CAT I applies to measurements performed on circuits not directly connected to the AC mains. Examples are measurements on circuits not derived from the AC mains and specially protected (internal) mains-derived circuits.

Measurement CAT II applies to protect against transients from energy-consuming equipment supplied from the fixed installation, such as TVs, PCs, portable tools, and other household circuits.

Measurement CAT III applies to protect against transients in equipment in fixed equipment installations, such as distribution panels, feeders and short branch circuits, and lighting systems in large buildings.

Measurement CAT IV applies to measurements performed at the source of the low-voltage installation. Examples are electricity meters and measurements on primary over current protection devices and ripple control units.

Safety Terms and Symbols

Safety Terms

Terms in this Manual. The following terms may appear in this manual:



Warning: Warning indicates the conditions or practices that could result in personal injury or death.



Caution: Caution indicates the conditions or practices that could result in damage to this product or other property.

Terms on the Product. The following terms may appear on this product:

Danger: It indicates an injury or hazard may immediately happen.

Warning: It indicates an injury or hazard may be accessible potentially.

Caution: It indicates a potential damage to the instrument or other property might occur.

Safety Symbols

Symbols on the Product. The following symbol may appear on the product:

	Direct current (DC)		Fuse
	Alternating current (AC)		Caution, risk of danger (refer to this manual for specific Warning or Caution information)
	Both direct and alternating current	CAT I	Category I overvoltage protection
	Ground terminal	CAT II	Category II overvoltage protection
	Conforms to European Union directives	CAT III	Category III overvoltage protection
	Equipment protected throughout by double insulation or reinforced insulation	CAT IV	Category IV overvoltage protection

2. Quick Start

General Inspection

After you get a new oscilloscope meter, make a check on the instrument according to the following steps:

1. Check whether there is any damage caused by transportation.

If it is found that the packaging carton or the foamed plastic protection cushion has suffered serious damage, do not throw it away first till the complete device and its accessories succeed in the electrical and mechanical property tests.

2. Check the Accessories.

The supplied accessories have been already described in the *Appendix A: Enclosure* of this Manual. You can check whether there is any loss of accessories with reference to this description. If it is found that there is any accessory lost or damaged, please get in touch with our distributor responsible for this service or our local offices.

3. Check the Complete Instrument.

If it is found that there is damage to the appearance of the instrument, or the instrument can not work normally, or fails in the performance test, please get in touch with our distributor responsible for this business or our local offices. If there is damage to the instrument caused by the transportation, please keep the package. With the transportation department or our distributor responsible for this business informed about it, a repairing or replacement of the instrument will be arranged by us.

Install the Batteries

The oscilloscope meter is powered by a 3.7V (18650) battery.



Warning: To avoid false readings, which could lead to possible electric shock or personal injury, please stop using and connect the device to the power supply for charging or replace the battery as soon as the low battery indicator appears.

Before replacing the battery, turn off the meter, disconnect test

leads and any connectors from any circuit under test, remove test leads from the input terminals. Use only the specified battery type.

Note: When charging, disconnect test leads from the input to open the charging cover and charge the device.

Use the following procedure to install the battery:

- (1) Power off, remove test leads and any connectors from the input terminals.
 - (2) Lift the tilt stand and loosen the screws with a suitable Phillips screwdriver and remove the battery cover.
 - (3) Observe the battery polarity indicated inside the battery compartment, Insert the battery.
 - (4) Place the battery cover back in its original position and tighten the screws.
-



Caution: To avoid instruments being damaged from battery leakage, remove the batteries and store them separately if the oscilloscope meter is not going to be used for a long period.

Adjusting the Tilt Stand

Pull the tilt stand outward to its maximum reach (about 85° to the meter body).

Power on/off

It can be turned on in the following ways:

- Press the  button at the bottom left of the host;
- Power on automatically when plugged in;
- Power on automatically after battery installation.

Note:

After the first boot, Reset, or battery removal, you will need to configure the date and time manually. Please refer to page **29** for detailed instructions on “**System Settings**”, specifically under the **Date | Time** section.





It can be turned off in the following ways:

- Manual shutdown, tap and hold  button (when the power is connected,

the shutdown will enter the standby mode);

- Automatic shutdown, emit a short beep one minute before shutdown, emit a long beep during shutdown;
- Low power automatic shutdown.

Selecting the Range

- Auto ranging is set as default when the meter is powered on, **Auto** is displayed.
- Under automatic range, press  or  to enter the manual range mode.
- Under manual range, each additional press of  sets the oscilloscope meter to the next higher range; each additional press of  sets the oscilloscope meter to the next lower range.
- Under manual range, press  to enter the auto range mode.

Note: Manual range is not available when measuring capacitance.

Measurement Connections

After selecting the desired measurement function, to avoid instrument damage, do not discretionarily switch the measurement function when measuring.

3.Instrument Panel



Front Panel and Keys

The front panel and keys of the oscilloscope meter are shown in Figure 3-1:





Figure 3- 1: Front panel

Description:

Num	Illustration in multimeter mode	Illustration in oscilloscope mode
1	Display area.	
2	The F1 - F4 keys are multi-function keys. In each menu mode, press the corresponding key to select the corresponding menu item.	
3	Function key,press to select the corresponding function.	Only  and  function.

Instrument Panel

4	Comparative value key.	Trigger menu key.
5	<p>Function of direction keys ▲ ▼:used for changing range.</p> <p>Function of  key:Restore auto gear.</p>	<p>Function of direction keys ▲ ▼: used for the amplitude scales.</p> <p>Function of direction keys ◀ ▶: used for zooming waveforms and the time base changing.</p> <p>Function of  key:Perform automatic setup.</p>
6	Relative value key.	Trigger value key,press it will automatically setting the trigger level to half of the current signal's Vpp.
7	Enter the system settings key.	
8	Image save key.	
9	Measurement input port.	
10	Value hold key.	Stop/Run key.
11	 :Long press to turn off, short press to turn on or display the status bar.	
12	Switch key for working state of oscilloscope and multimeter.	
13	Maximum and minimum value measurement button.	Measurement value display button.

Side Panel



Figure 3-2: Side panel

Description:

1. Charging or USB communication interface(Note:The measurement input port is not available when the interface is charging or communicating).
2. Bracket.

4. How to Use the Multimeter

About This Chapter

This chapter introduces the multimeter function and provides some basic examples of basic operations and how to use the menu.

Instrument Interface

The oscilloscope meter uses four 4-mm safety banana plug input ends: **A**、**mA**、**COM**、**VΩ** \rightarrow \leftarrow .

Multimeter interface:

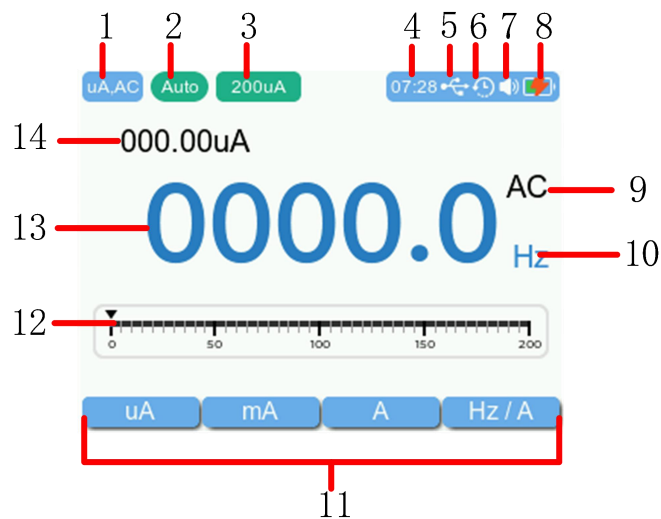

Multimeter interface

Description:

1. Measurement type indication:

Measurement type	Description
V,DC、 mV,DC	DC voltage measurement
V,AC、 mV,AC	AC voltage measurement
Res	Resistance measurement
Cont	On/Off measurement
Diode	Diode measurement
CAP	Capacitance measurement

Freq	Frequency measurement
uA,DC、mA,DC、A,DC	DC current measurement
uA,AC、mA,AC、A,AC	AC current measurement

2. Range indication: **Manu** means manual range; **Auto** means automatic range.
3. Current measurement range.
4. Time display.
5. Indicating that there is a USB cable inserted.
6. Automatic shutdown sign: Displays the flag when enabled. Closing will hide the identity.
7. Operation beep identification: Displays the flag when enabled. Closing will hide the identity.
8. Battery level and charge indication.
9. DC/AC/On-Off/Diode/Capacitance indication.
10. Main unit of measurement.
11. F1~F4 operation menu.
12. Range simulation strip.
13. Main measurement value.
14. Secondary measurement value.

Measurement units

Sign	Description
M	Mega 1E+06 (1000000)
k	kilo 1E+03 (1000)
m	milli 1E-03 (0.001)
μ	micro 1E-06 (0.000001)
n	nano 1E-09 (0.000000001)

Sign	Description	Measurement type
V	Voltage	Voltage
A	Ampere	Current
Ω	Ohm	Resistance

Hz	Hertz	Frequency
%	Percent	Duty cycle
F	Farad	Capacitance

Input terminals





The terminal connections for the different measurement functions of the oscilloscope meter are described in the table below.



Warning: Before starting any measurement, observe the rotary switch position of the oscilloscope meter, and then connect the test leads to the correct terminals.



Caution: To avoid damaging the oscilloscope meter, do not exceed the rated input limit.

Measurement key	Input terminals	Overload protection
	$V \Omega \rightarrow \leftarrow$ COM	750 VAC/1000 VDC
	$V \Omega \rightarrow \leftarrow$ COM	250 VAC/300 VDC
	mA COM	600mA/1000V fast-acting fuse
	A COM	10A/1000V fast-acting fuse

Making Measurements

Note: When the stylus is inserted into the measurement input port **A**、**mA**、 $V \Omega \rightarrow \leftarrow$, the instrument automatically switches to the default measurement type.







Measuring AC or DC Voltage



Warning: Do not measure any voltage of over 1000 Vdc or 750 Vac rms to avoid instrument damage or electric shock.
Do not apply more than 1000 Vdc or 750 Vac rms between the common terminal and the earth ground to avoid instrument

damage or electric shock.

This oscilloscope meter displays DC voltage values as well as their polarity. Negative DC voltages will display a negative sign on the left of the screen.

1. Press  to switch **DC Voltage measurement** mode, ***,DC** will be displayed in the upper left corner(* denotes mV or V).Then press  to switch into **AC Voltage measurement** mode, ***,AC** will be displayed in the upper left corner(* denotes mV or V).And then press  or  to select mV or V measurement function,press  or  to up and down measurement scales.
2. Connect the black test lead to the **COM** terminal and the red test lead to the **VΩ→←** terminal.

DC/AC Voltage Measurement connect test leads:

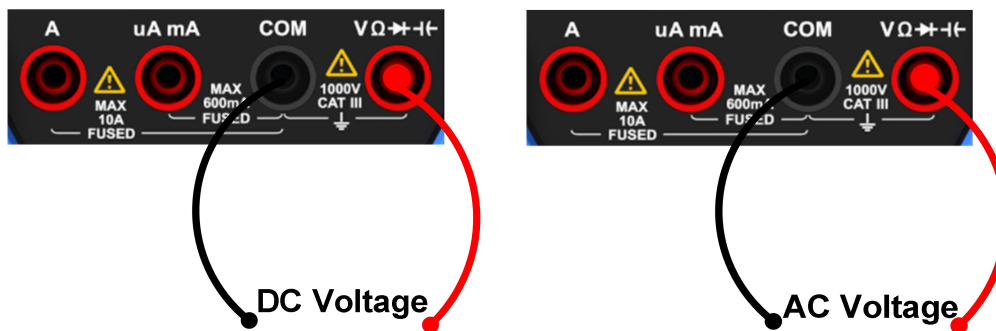

3. Probe the test points and read the display.

Note:When measuring AC voltage, press  to cycle through frequency measuring and original measuring.

Measuring Resistance

 **Caution:** To avoid possible damage to your oscilloscope meter or to the equipment under test, disconnect the circuit power and discharge all high-voltage capacitors before measuring resistance.

1. Press  to enter resistance testing mode,**Res** will be displayed in the upper left corner.

2. Connect the black test lead to the **COM** terminal and the red test lead to the **VΩ** terminal.

Resistance Measurement connect test leads:

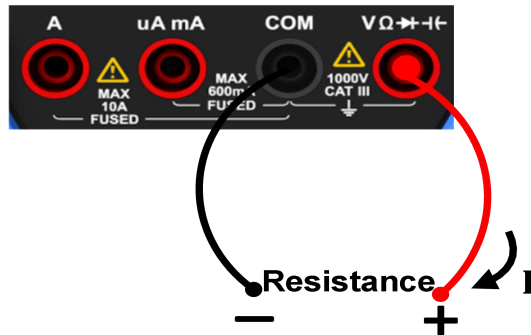

3. Probe the test points and read the display.

Measuring Continuity



Caution: To avoid possible damage to your oscilloscope meter or to the equipment under test, disconnect the circuit power and discharge all high-voltage capacitors before testing for continuity.

1. Press **Ω** to enter continuity testing mode, **Cont** will be displayed in the upper left corner.
2. Connect the black test lead to the **COM** terminal and the red test lead to the **VΩ** terminal.

Continuity Measurement connect test leads:

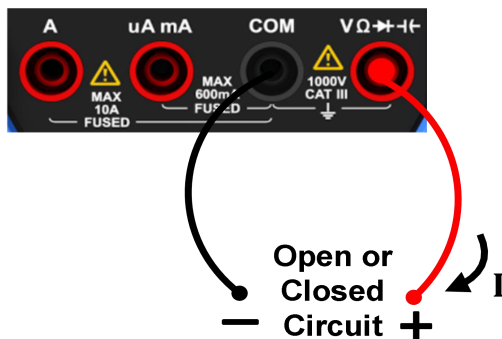



3. Probe the test points to measure the resistance in the circuit. When the reading is below 50 Ω, the oscilloscope meter will beep continuously.

Measuring Diodes



Caution: To avoid possible damage to your oscilloscope meter or to the equipment under test, disconnect the circuit power and discharge all high-voltage capacitors before testing diodes.

1. Press  to enter diode testing mode, **Diode** will be displayed in the upper left corner.
2. Connect the black test lead to the **COM** terminal and the red test lead to the **VΩ**  terminal.

Diode Measurement connect test leads:

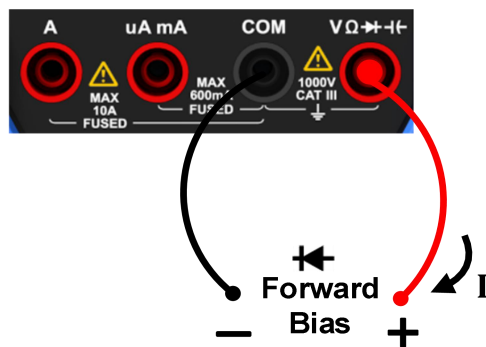

3. Connect the red test lead to the positive terminal of the diode and the black test lead to the negative terminal .
4. Read the diode forward bias. If the test lead connection is reversed, the oscilloscope meter will display "OL".

Measuring Capacitance



Caution: To avoid possible damage to the oscilloscope meter or to the equipment under test, disconnect circuit power and discharge all high-voltage capacitors before measuring capacitance. Use the DC voltage function to confirm that the capacitor is fully discharged.

1. Press  to enter capacitance testing mode, **CAP** will be displayed in the upper left corner.
2. Connect the black test lead to the **COM** terminal and the red test lead to

the $V\Omega$ terminal.

Capacitance Measurement connect test leads:

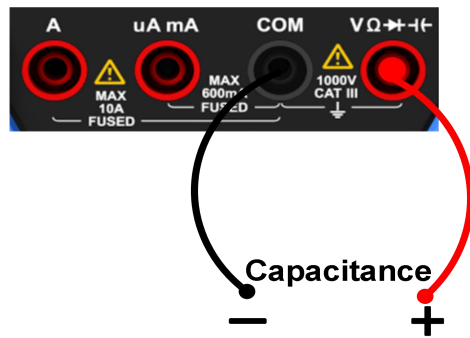

3. Probe the test points and read the display.

Measuring Frequency

1. Press Hz to enter frequency measurement mode, **Freq** will be displayed in the upper left corner.
2. Connect the black test lead to the **COM** terminal and the red test lead to the $V\Omega$ terminal.

Frequency Measurement connect test leads:

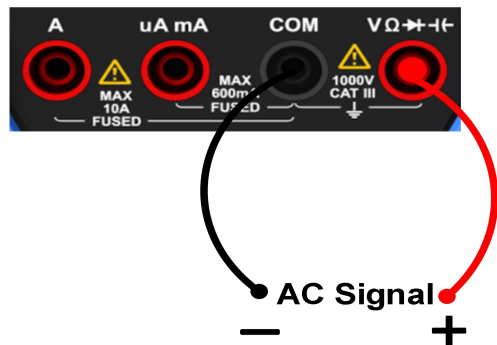

3. Probe the test points and read the display.
4. Press **F4** to switch between the frequency and duty cycle measurements.

Note: When measuring AC voltage or AC current, press **F4** to cycle through frequency measuring and original measuring.

To measure the frequency of signal with large amplitude, it is recommended to

press **F4** to measure the frequency in AC voltage measurement mode.

Measuring DC or AC Current

Warning: Never attempt an in-circuit current measurement where the open-circuit potential to earth is greater than 250 V. Doing so will cause damage to the oscilloscope meter and possible electric shock or personal injury.

Caution: To avoid possible damage to the oscilloscope meter or to the equipment under test, check the oscilloscope meter's fuse before measuring current. Use the proper terminals, function, and range for your measurement. Never place the test leads in parallel with any circuit or component when the leads are plugged into the current terminals.

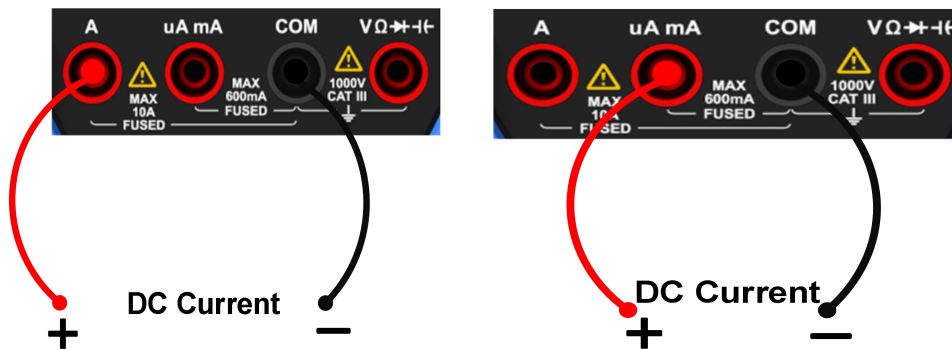

1. Turn off the power of the measured circuit. Discharge all high-voltage capacitors.
2. Connect the black test lead to the **COM** terminal.
3. Press **A** to switch **DC Current measurement** mode, ***DC** will be displayed in the upper left corner(* denotes uA、 mA or A).Then press **A** to switch into **AC Current measurement** mode, ***AC** will be displayed in the upper left corner(* denotes uA、 mA or A).Press **F1** ~ **F3** to select uA、 mA or A.When choosing uA or mA,connect the red test lead to the mA terminal;when choosing A,connect the red test lead to the A terminal.

DC Current Measurement connect test leads:

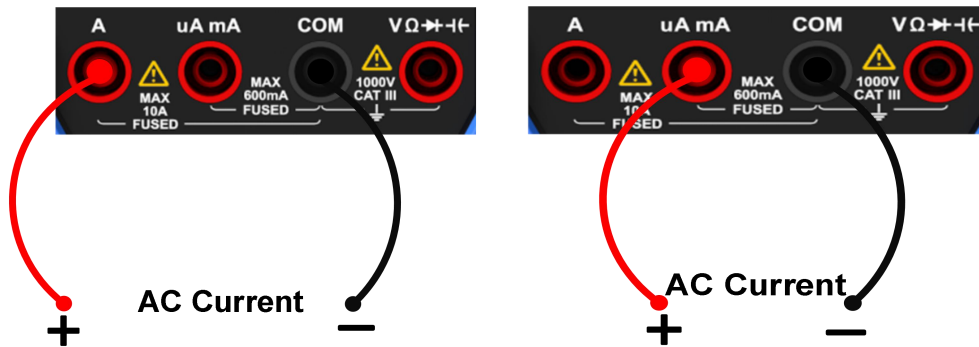

AC Current Measurement connect test leads:



4. Disconnect the circuit path to be tested. Connect the black test lead to one side of the circuit (with a lower voltage); connect the red test lead to the other side (with a higher voltage). Reversing the leads will produce a negative reading, but will not damage the oscilloscope meter.
5. Turn on the power of the measured circuit, and read the display. Press  or  to the position with higher range. When "OL" is displayed, it indicates the input exceeds.
6. Turn off the power of the measured circuit and discharge all high-voltage capacitors. Remove the test leads and restore the circuit to the original condition.





Note: When measuring AC current, press  to cycle through frequency measuring and original measuring.

Multimeter Features

Setting Scale

1. Press  to enter automatic gear mode.
2. In the automatic gear mode, press  or  to enter manual gear mode.

Setting Range

1. Press  to switch into **DC Voltage measurement**, then press 
or  to select mV or V, and then press  or  to up and down

measurement scales.

2. Press **V** to switch into **AC Voltage measurement**, then press **F1** , **F2** or **F4** to select mV、 V or Hz/V, and then press **▲** or **▼** to up and down measurement scales.
3. Press **A** to switch into **DC Current measurement**, then press **F1** ~ **F3** to select uA、 mA or A, and then press **▲** or **▼** to up and down measurement scales.
4. Press **A** to switch into **AC Current measurement**, then press **F1** ~ **F4** to select uA、 mA、 A or Hz/A, and then press **▲** or **▼** to up and down measurement scales.

Making MAX/MIN Measurements

Press **MAXMIN** to enter **MAX/MIN measurement**. When the button is pressed, it will automatically enter the manual gear mode. Press the button again to exit the MAXMIN mode and resume the automatic gear mode.



Making Comparative Measurements

In multimeter mode, press **COMP** to enter comparison measurement mode. (Before using this function, it is necessary to set the corresponding comparison range. For detailed instructions on setting up, please refer to page 29, "System Settings".)



- When the condition is met for being outside the range: If the current measurement value displayed on the main screen is outside the comparison range, it will be considered as a pass.
- When the condition is met for being outside the range: If the current measurement value displayed on the main screen is inside the comparison range, it will be considered as a fail.
- When the condition is met for being inside the range: If the current measurement value displayed on the main screen is inside the comparison range, it will be considered as a pass.
- When the condition is met for being inside the range: If the current measurement value displayed on the main screen is outside the comparison range, it will be considered as a fail.

Value Hole Mode

The value hold mode keeps the current reading on the display.

1. Press , the current reading will be maintained, **HOLD** will be displayed. Simultaneously, the device will continue to display the actual measurement value in the status bar at the top of the main screen.
2. Press it again to exit the mode.



Making Relative Measurements

When making relative measurements, reading is the difference between a stored reference value and the input signal.

1. Press **REL** to enter the relative mode, Δ will be shown on the display.

The measurement value when pressing **REL** as the reference value. In this mode, $\Delta(\text{current reading}) = \text{input value} - \text{reference value}$.

2. Press it again to exit the mode.

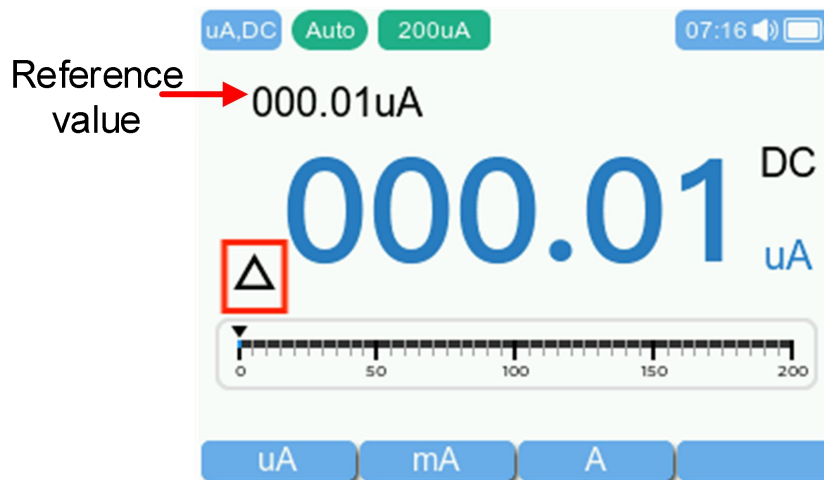

In relative measurement, the manual range mode will be activated automatically. (When the range is exceeded, the relative value mode cannot be turned on, that is, this function is only available under the manual range mode.)

5.How to Use the Oscilloscope

Introduction to the User Interface of the Oscilloscope

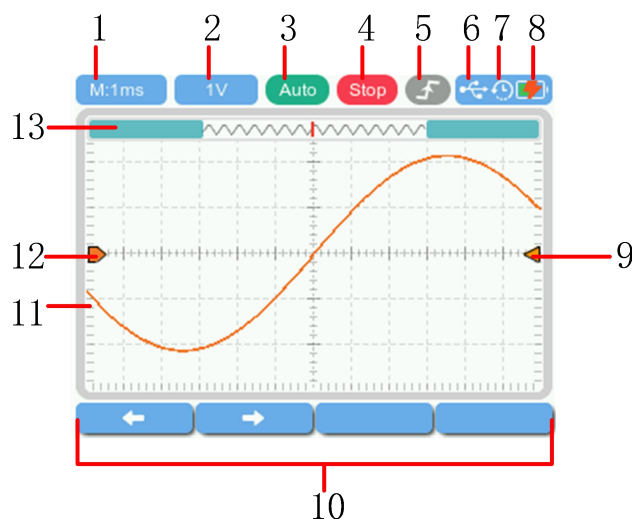

Figure 3-3: Oscilloscope Interface

Description:

1. Time base(In the vertical direction,the per grid denotes time).
2. Amplitude(In the vertical direction,the per grid denotes voltage or current).
3. Trigger operation mode:

Auto: In this trigger mode,if the specified trigger condition is not detected, the oscilloscope will initiate a forced triggering and acquisition process to display the waveform.This triggering method is suitable for unknown signal levels or when displaying DC signals, as well as when trigger conditions occur frequently and there is no need for forced triggering.When the base time is greater than or equal to 100 milliseconds, enter the scanning mode.

Normal: In this trigger mode, the oscilloscope only performs triggering and acquisition when the specified trigger condition is detected.This triggering method is applicable to low repetition rate signals, selective capture of specific events determined by trigger settings, and ensuring a stable display by preventing automatic triggering by the

oscilloscope.

Single: In this trigger mode, the oscilloscope performs a single triggering and acquisition only when the specified trigger condition is detected, and then stops. This triggering method is suitable for situations where a single capture of a specific event is needed for subsequent analysis (enabling translation and scaling of the current displayed waveform, with subsequent waveform data not overwriting the current waveform). After a single triggering, the oscilloscope enters the "STOP" state.

4. The trigger status indicates the following information:

Trig: A trigger has been detected and post trigger information is being collected.

Ready: All pre-trigger data have been obtained and the oscilloscope is ready.

Scan: Continuously collect and display waveform data.

Stop: Stop collecting waveform data.

5. Trigger edge type.
6. It indicates that there is a USB disk connecting.
7. Automatic shutdown sign: Displays the flag when enabled. Closing will hide the identity.
8. Battery level and charge indication..
9. Trigger level horizontal position.
10. F1~F4 operation menu.
11. Waveform display area.
12. Channel waveforms.
13. Waveform scroll bar.

Measuring System

Automatic Measurement

In oscilloscope mode, press  can display automatic measurement value, the screen displays six measurement types in the lower left corner: Freq、Max、Min、Vpp、Avg and Rms.

The automatic measurement of voltage parameters

The oscilloscopes provide automatic voltage measurements including Avg, Vpp, Rms, Max, Min and Vamp. Figure 3-4 below shows a pulse with some of the voltage measurement points.

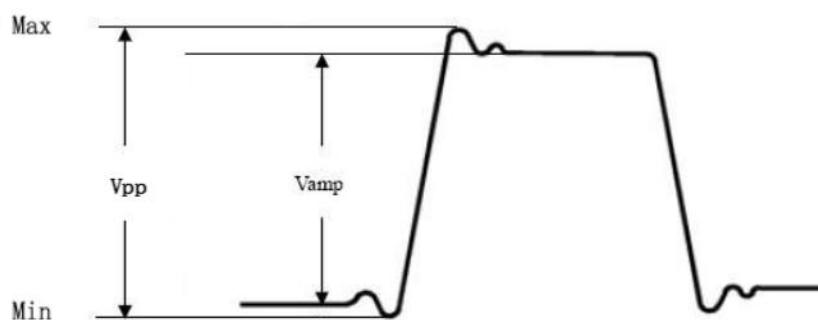

Figure 3-4

Avg: <1 cycle: The whole displayed waveform is used for calculation;
>1 cycle: A waveform of n cycles is used for calculation.



Vpp: Peak-to-Peak Voltage.

Rms: <1 cycle: The whole displayed waveform is used for calculation;
>1 cycle: A waveform of n cycles is used for calculation.

Max: The most positive peak voltage measured over the entire waveform.

Min: The most negative peak voltage measured over the entire waveform.

Measurement:

1. Press  to switch into oscilloscope mode.
2. Press  to open or close automatic measurement function. The measurement values of the waveform will be displayed in the lower left corner of the screen.



3. Press to enter voltage measurement, press or to select **mV** or **V** measurement unit, and then press or to up and down measurement gear, press or to adjust time base gear.
4. Press to enter current measurement, press ~ to select **uA**、**mA** or **A** measurement unit, and then press or to up and down measurement gear, press or to adjust time base gear.
5. Press to enter pause mode, if you press or can horizontally shift the waveform and press or to zoom in or out the waveform.
6. Press , automatically setting the trigger level to half of the current signal's Vpp.

Trigger System

The trigger determines when the oscilloscope starts to acquire data and display waveforms. Once the trigger is set correctly, it can convert an unstable display into a meaningful waveform.

When the oscilloscope starts to acquire data, it first acquires enough data to draw the waveform on the left side of the trigger point. The oscilloscope continuously acquires data while waiting for the trigger condition to occur.

When a trigger is detected, the oscilloscope continuously acquires enough



data to draw a waveform on the right of the trigger point.

The trigger mode of this series of oscilloscopes is edge trigger.

The edge trigger mode is to trigger on the trigger electrical level of the edge of the input signal, that is, trigger on the rising and falling edges of the input signal.



Press  to enter edge trigger menu.

The description of the trigger system setting menu is as follows:

Function Menu	Setting	Description
Mode	Auto	Waveforms can be acquired without detecting trigger conditions.
	Normal	The waveform is acquired only when the trigger conditions are met.
	Single	When a trigger is detected, a waveform is sampled and then stopped.
Edge		Trigger on the rising edge of the signal.
		Trigger on the falling edge of the signal.

Mode: Press  can cycle through Auto、 Normal or Single.

Edge: Press  can cycle through rising edge and falling edge.

Trigger level position: Press  or  can up and down trigger level position.

6. Save and Recall Picture

1. **Save picture:** Press  button will initiate the process of capturing a screenshot. Upon completion, a prompt will appear containing information about the directory where the screenshot is saved. By default, it is possible to save up to 20 screenshots, with new captures overwriting older ones once the limit is reached.





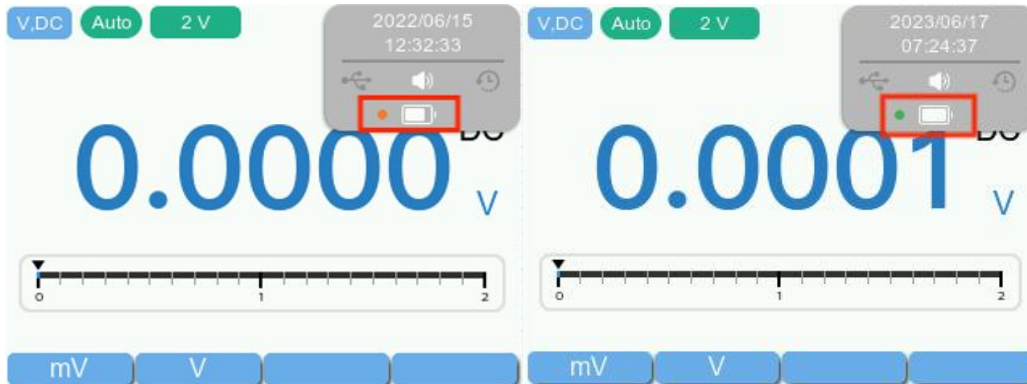

Note: The dot next to the battery will display orange if the storage space is insufficient, and it will display green if the storage space is adequate.



2. **Recall picture:** Upon connecting the USB cable to a computer, to open the saved image, select the path where the image is stored.

7. System Settings

Press  to enter the system function menu. Press  or  to select the desired function menu, and then press  or  to select desired setting.

- **Date|Time**





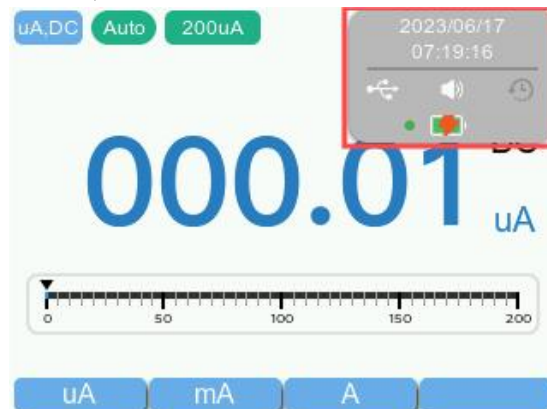

Select **Date|Time** page, you can do the following.

The description of the option is as follows:

Page options	Description
Date, Time	Set the required time.
Hour 12h	Set the display mode to 12-hour format.
Date Tran	Set the time display format.

1. Press the power button  can display the hidden time icon; press any button, can hide the date.





2. **Time setting:** Select **Date, Time** option. Press  or  to select year、month、day、hour、minute and second, and then press  or  to set required time.
3. **12-hour format setting:** Select **Hour 12h** option. Press  the time display will be in the 12-hour format and press it again will switch to 24-hour format.
4. **Date display settings:** Select **Date Tran** option. Press  the date will be displayed in the format of DD/MM/YYYY (day/month/year), and press it again, the date will be displayed in the format of YYYY/MM/DD.

● **Display**

Select **Display** page,you can do the following.

The description of the option is as follows:

Page options	Description
Dark Mode	Set the multimeter display mode
Brightness	Adjust brightness High, Mid or Low.

1. **Multimeter display mode setting:**Select **Dark Mode** option,and then press ,the "Reboot device Press again" prompt box will pop up on the screen. Pressing the  button at the same time will restart the device and apply the new display mode.Press any key to undo the action currently being performed.





2. **Brightness setting:**Select **Brightness** option,and then press ,the brightness varies between Low, Mid, and High.

● **Sound**

Select **Sound** page,you can do the following.

The description of the option is as follows:

Page options	Description
Voice	Set the key operation prompt tone.
Volume	Set the volume.
Warning	Set alarms.

1. **Voice setting:**Select **Voice** option,and then press  will produce a sound prompt;press it again will be no sound prompt upon pressing a key.
2. **Volume setting:**Select **Volume** option,press  will increase volume; press  will decrease volume.The sound is set to maximum by

default.





3. **Warning setting:**Select **Warning** option,and then press  an alarm notification will be enabled;press it again will there will be no alarm notification(Such as: probe socket detection.).

● **System**

Select **System** page,you can do the following.

The description of the option is as follows:

Page options	Description
Auto Power Off	Set automatic shutdown.
Power Off	Set the automatic shutdown time.
Reset	Restore default setting.
About	Display information about the instrument.

1. **Automatic shutdown setting:**Select **Auto Power Off** option,and then press  will enable automatically shut down.When enabled, the device will automatically power off after a specified period of inactivity; pressing the button again will require manual shutdown.
2. **Automatic shutdown time setting:**Select **Power Off** option.Press  the shutdown time will change between 5 min and 30 min.
3. **Reset setting:**Select **Reset** option,and then press ,”Reset settings Press again” will pop up on screen, press  at the same time,the device will restart and restore default setting.Press any key to undo the action currently being performed..

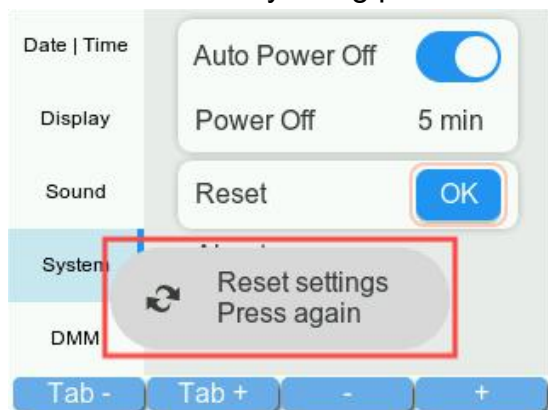



● **DMM**

Select **DMM** page,you can do the following:

The description of the option is as follows:

System Settings

Page options	Description
Cont SENS	Set the on-off value(HDS120 series device can not be set).
Comp Range	Set comparison range.
Out Range Pass	Set the comparison pass condition range as outside the interval.

1. **Set on-off range:**Select **Comp Range** option, and then press  or  can modify the range of the interval (left and right intervals will be automatically determined).
2. **Set out range pass:**Select **Out Range Pass** option,and then press  to enable or disable the option.Enabling this option sets the comparison pass condition as outside the interval. Disabling this option sets the comparison pass condition as inside the interval.

8. Technical Specifications

Standard conditions: The environment temperature is 18°C to 28°C, the relative humidity is less than 80%.

Note:

When measuring AC voltage, accuracy guarantee range is 10% to 100% of the range.

When measuring DC voltage, AC/DC current or capacitance, accuracy guarantee range is 5% to 100% of the range.

Multimeter Specification

Function		Measurement Range	Resolution/ Frequency Range	Accuracy ± (% of reading + LSB)	
DC Voltage (V)	mV	20.000mV	0.001mV	±(0.1%+20dig)	
		200.00mV	0.01mV	±(0.1%+6dig)	
	V	2.0000V	0.1mV	±(0.1%+5dig)	
		20.000V	1mV		
		200.00V	10mV		
1000.0V	0.1V	±(0.15%+5dig)			
AC Voltage (V)	mV	20.000mV	0.001 mV	VRMS Freq range: 40Hz-1000Hz	±(0.6%+10dig)
		200.00mV	0.01mV		
	V	2.0000V	0.1mV		
		20.000V	1mV		
		200.00V	10mV		
		750.0V	0.1V		±(0.8%+10dig)
DC Current (A)	μA	200.00μA	0.01μA	±(0.6%+10dig)	
		2000.0μA	0.1μA	±(0.5%+10dig)	
	mA	20.000mA	1μA	±(0.6%+10dig)	
		200.00mA	10μA	±(0.5%+10dig)	
	A	2.0000A	100μA	±(1.0%+10dig)	
		10.000A ^[1]	1mA	±(2.0%+10dig)	
AC Current (A)	μA	200.00μA	0.01μA	VRMS Freq range: 40Hz-1000Hz	±(0.8%+10dig)
		2000.0μA	0.1μA		
	mA	20.000mA	1μA		
		200.00mA	10μA		

Technical Specifications

	A	2.0000A	100 μ A		$\pm(1.5\%+10\text{dig})$
		10.000A ^[1]	1mA		$\pm(2.5\%+10\text{dig})$
Resistance(Ω)		200.00 Ω	0.01 Ω		$\pm(0.8\%+10\text{dig})$
		2.0000k Ω	0.1 Ω		$\pm(0.3\%+5\text{dig})$
		20.000k Ω	1 Ω		$\pm(0.3\%+5\text{dig})$
		200.00k Ω	10 Ω		
		2.0000M Ω	100 Ω		$\pm(0.5\%+5\text{dig})$
		20.000M Ω	1k Ω		
		100.00M Ω	10k Ω		
Capacitance(F)		2.000nF	1pF		$\pm(5.0\%+10\text{dig})$
		20.00nF	10pF		$\pm(3.0\%+10\text{dig})$
		200.0nF	100pF		
		2.000 μ F	1nF		
		20.00 μ F	10nF		
		200.0 μ F	100nF		
		2.000mF	1 μ F		
		20.00mF ^[2]	10 μ F		
Frequency^[3] (Hz)		200.00Hz	0.01Hz		$\pm(0.1\%+5\text{dig})$
		2.0000kHz	0.1Hz		
		20.000kHz	1Hz		
		200.00kHz	10Hz		
		2.0000MHz	0.1kHz		
		20.000MHz	1kHz		
Duty Cycle^[4] (%)		0.1% -99.9% (Typical: V _{rms} =1 V, f=100Hz)	0.1%		$\pm(1.2\%+3\text{dig})$
		0.1%-99.9%(\geq 1 kHz)			$\pm(2.5\%+10\text{dig})$
Diode		3.0000V	0.0001V		$\pm(1.0\%+10\text{dig})$
On-Off		1000.0 Ω	0.1 Ω		
Maximum Reading	20000				

[1] When measuring current, for 10A the measuring duration should not be over 2 minutes within 10 minutes, and in this 10 minutes, no other current should flow through except within the measuring duration.

[2] When measuring capacitance, for the 20.00mF range, the measuring duration should be over 30 seconds.

[3] When measuring frequency, the typical waveform is Square or Sine. The

Technical Specifications

signal meets the following conditions:

Frequency	Amplitude(rms)
1 Hz – 20 MHz	≥ 1 V

[4] When measuring duty cycle, the typical waveform is Square.

Note: when measuring resistance and capacitance, the influence of the resistance reactance of the pen itself on the measured value should be considered.

Oscilloscope Specification

Characteristics	Instruction
Analog bandwidth	1MHz (only ACV scale)
Maximum sample	5.0MSa/s
Channel	1
Input impedance	approximately 10MΩ
Time base range	2.5us~10s/grid
Time base accuracy	±(0.01% + 0.1div)
Voltage vertical sensitivity range	30mV~500V/grid
Current vertical sensitivity range	100μA~5A/grid
Vertical amplitude accuracy	±(5% + 0.2div)
Maximum voltage limit	1000V DC+AC Peak value
Maximum current limit	15A DC+AC Peak value
Trigger mode	Auto/Normal/Single
Autoset	Time base/Vertical amplitude/Trigger value
Trigger edge	Rise edge/Fall edge
Measurement function	Vmax,Vmin,Vp-p,Vavg,Vrms,Hz

Note: The signal is within 5dB attenuation with an analog bandwidth of up to 1MHz.

General Specification

Characteristics	Instruction
Sleep Mode	√
Low battery indication	√
Backlight	√
Input Protection	√

Technical Specifications

Input Impedance	≥ 10 MΩ
Battery	Single 18650 3.7v
Display	2.8 inch IPS:320*240 resolution
Weight (without package)	Approx. 0.33kg(without battery)
Dimension	188mm(Length)* 93mm(Width)*41.5mm(Depth)
Working temperature	0°C to 40°C
Storage temperature	−10°C to 60°C
Relative Humidity	≤ 80%
Altitude	Operating: 3,000 meters Non-operating: 15,000 meters

Interval Period of Adjustment:

One year is recommended for the calibration interval period.

9. Appendix

Appendix A: List of Accessories

- 1 set of probes
- 1 quick guide
- 1 USB-TYPEC line

Appendix B: Maintenance and Cleaning

General maintenance

Do not store or place the instrument in a place where the LCD screen will be exposed to direct sunlight for a long time.

Caution: Do not let spray, liquid or solvent touch the instrument or probe to prevent damage to the instrument or probe.

Cleaning:

Check the instrument and probe frequently according to the operation. Clean the external surface of the instrument as follows:

1. Please wipe the floating dust outside the instrument and probe with a soft cloth. When cleaning the LCD, be careful not to scratch the transparent LCD protection screen.
2. Wipe the instrument with a damp but non dripping soft cloth. Please disconnect the power supply. It can be scrubbed with soft detergent or water. Do not use any abrasive chemical cleaning agent to avoid damaging the instrument or probe.



Warning: Please make sure the instrument is dry before re-energizing to avoid electrical short circuit or personal injury caused by moisture.

Charging and Replacement of Battery

During the long-term storage of the device, the battery may be too low due to the self-discharge of the lithium battery and the device cannot be turned on.

This is a normal phenomenon.

To pre-charge the device for 0.5 to 1 hour (depending on the storage time) before turning it on. In addition, if the device is not used for a long time, it is recommended to charge it at regular intervals to avoid over-discharge of the lithium battery.

Battery Charging

The lithium battery may not be fully charged when delivered. The power supply and battery indicator symbols in the upper right corner of the screen are explained as follows:

Model	Charging	Discharging
120 series device	≥2.5 hour	≥24 hour

 symbol indicates the power-on charging status;

 symbol indicates battery power supply;

 symbol indicates that there is only about five minutes of use time left.

Please charge as soon as possible according to the relevant tips to avoid damage to the battery.

Charging Method

Connect the oscilloscope meter to a computer or other equipment through a USB data cable for charging (pay attention to the load capacity of the power supply equipment to avoid abnormal operation of the equipment).

Note

To avoid overheating of the battery during charging, the ambient temperature must not exceed the allowable value given in the technical specifications.

Replacement of Lithium Battery

Generally, the battery does not need to be replaced. However, when necessary, it can only be replaced by qualified personnel, and only **lithium batteries of the same specification** can be used.