

General Warranty

We warrant that the product will be free from defects in materials and workmanship for a period of 1 years from the date of purchase of the product by the original purchaser from our company. This warranty only applies to the original purchaser and is not transferable to a third party.

If the product proves defective during the warranty period, we will either repair the defective product without charge for parts and labour, or will provide a replacement in exchange for the defective product. Parts, modules, and replacement products used by our company for warranty work may be new or reconditioned like new. All replaced parts, modules and products become the property of our company.

In order to obtain service under this warranty, the customer must notify our company of the defect before the expiration of the warranty period. Customer shall be responsible for packaging and shipping the defective product to the designated service centre, a copy of the customers proof of purchase is also required.

This warranty shall not apply to any defect, failure or damage caused by improper use or improper or inadequate maintenance and care.

We shall not be obligated to furnish service under this warranty a) to repair damage resulting from attempts by personnel other than our company representatives to install, repair or service the product; b) to repair damage resulting from improper use or connection to incompatible equipment; c) to repair any damage or malfunction caused by the use of not our supplies; or d) to service a product that has been modified or integrated with other products when the effect of such modification or integration increases the time or difficulty of servicing the product.

Please contact the nearest Sales and Service Offices for services.

Excepting the after-sales services provided in this summary or the applicable warranty statements, we will not offer any guarantee for maintenance declared or hinted, including but not limited to the implied guarantee for marketability and special-purpose acceptability. We should not take any responsibilities for any indirect, special, or consequent damages.

※: The illustrations, interface, icons and characters in the user manual may be slightly different from the actual product. Please refer to the actual product.

Table of Contents

1. Safety Information	1
General Safety Requirements	1
Measurement Category	3
Safety Terms and Symbols	3
2. Quick Start	5
General Inspection	5
Install the Batteries	5
Adjusting the Tilt Stand	6
Power on/off	6
Selecting the Range	7
Measurement Connections	7
Instrument Panel	9
Front Panel and Keys	9
Side Panel	11
Instrument Interface	12
Multimeter interface	12
Oscilloscope interface	13
3. Save and Recall Picture	16
4. System Settings	17
5. Appendix	21
Appendix A: List of Accessories	21
Appendix B: Maintenance and Cleaning	21
General maintenance	21
Charging and Replacement of Battery	22
Replacement of Lithium Battery	22

1. Safety Information

(Be sure to read the safety information before using this product.)

General Safety Requirements

Before any operations, please read the following safety precautions to avoid any possible bodily injury and prevent this product or any other products connected from damage. In order to avoid any contingent danger, this product is only used within the range specified.

- **Limit operation to the specified measurement category, voltage, or amperage ratings.**
- **Do not use the oscilloscope meter if it is damaged.** Before you use the oscilloscope meter, inspect the case. Look for cracks or missing plastic. Pay particular attention to the insulation surrounding the connectors.
- **Do not use the test leads provided for other products.** Use only the certified test leads specified for this product.
- Inspect the test leads for damaged insulation or exposed metal.
- Before use, verify the oscilloscope meter's operation by measuring a known voltage.
- **Only the qualified technicians can implement the maintenance.**
- **Always use the specified battery type.** The power for the oscilloscope meter is supplied with a battery. Observe the correct polarity markings before you insert the batteries to ensure proper insertion of the batteries in the oscilloscope meter.
- **Check all Terminal Ratings.** To avoid fire or shock hazard, check all ratings and markers of this product. Refer to the user's manual for more information about ratings before connecting to the oscilloscope meter.
- Do not operate the oscilloscope meter with the cover or portions of the cover removed or loosened.
- **Use Proper Fuse.** Use only the specified type and rating fuse for the oscilloscope meter.
- **Do not operate if in any doubt.** If you suspect damage occurs to the

oscilloscope meter, have it inspected by qualified service personnel before further operations.

- **Do not operate this product in wet or damp conditions.**
- **Do not operate in an explosive atmosphere.**
- **Keep product surfaces clean and dry.**
- Do not apply more than the rated voltage (as marked on the oscilloscope meter) between terminals, or between terminal and earth ground.
- When measuring current, turn off the circuit power before connecting the oscilloscope meter in the circuit. Remember to place the oscilloscope meter in series with the circuit.
- When servicing the oscilloscope meter, use only the specified replacement parts.
- Use caution when working above 60 V DC, 30 V AC RMS, or 42.4 V peak. Such voltages pose a shock hazard.
- When using the test leads, keep your fingers behind the finger guards on the test leads.
- Remove the test leads from the oscilloscope meter before you open the battery cover.
- To avoid false readings, which may lead to possible electric shock or personal injury, replace the battery as soon as the low battery indicator appears and flashes.
- Disconnect circuit power and discharge all high-voltage capacitors before testing resistance, continuity, diodes, or capacitance.
- **Use the proper terminals, function, and range for your measurements.** When the range of the value to be measured is unknown, set the rotary switch position as the highest range, or choose the auto ranging mode. To avoid damages to the oscilloscope meter, do not exceed the maximum limits of the input values shown in the technical specification tables.
- Connect the common test lead before you connect the live test lead. When you disconnect the leads, disconnect the live test lead first.
- Before changing functions, disconnect the test leads from the circuit under test.

Measurement Category

The oscilloscope meter has a safety rating of 1000 V, CAT III.

Measurement category definition

Measurement CAT I applies to measurements performed on circuits not directly connected to the AC mains. Examples are measurements on circuits not derived from the AC mains and specially protected (internal) mains-derived circuits.

Measurement CAT II applies to protect against transients from energy-consuming equipment supplied from the fixed installation, such as TVs, PCs, portable tools, and other household circuits.

Measurement CAT III applies to protect against transients in equipment in fixed equipment installations, such as distribution panels, feeders and short branch circuits, and lighting systems in large buildings.

Measurement CAT IV applies to measurements performed at the source of the low-voltage installation. Examples are electricity meters and measurements on primary over current protection devices and ripple control units.

Safety Terms and Symbols

Safety Terms

Terms in this Manual. The following terms may appear in this manual:



Warning: Warning indicates the conditions or practices that could result in personal injury or death.



Caution: Caution indicates the conditions or practices that could result in damage to this product or other property.

Terms on the Product. The following terms may appear on this product:









Danger: It indicates an injury or hazard may immediately happen.

Warning: It indicates an injury or hazard may be accessible potentially.

Caution: It indicates a potential damage to the instrument or other property might occur.

Safety Symbols

Symbols on the Product. The following symbol may appear on the product:

	Direct current (DC)		Fuse
	Alternating current (AC)		Caution, risk of danger (refer to this manual for specific Warning or Caution information)
	Both direct and alternating current	CAT I	Category I overvoltage protection
	Ground terminal	CAT II	Category II overvoltage protection
	Conforms to European Union directives	CAT III	Category III overvoltage protection
	Equipment protected throughout by double insulation or reinforced insulation	CAT IV	Category IV overvoltage protection

2. Quick Start

General Inspection

After you get a new oscilloscope meter, make a check on the instrument according to the following steps:

1. Check whether there is any damage caused by transportation.

If it is found that the packaging carton or the foamed plastic protection cushion has suffered serious damage, do not throw it away first till the complete device and its accessories succeed in the electrical and mechanical property tests.

2. Check the Accessories

The supplied accessories have been already described in the 错误! 未定义书签。 of this Manual. You can check whether there is any loss of accessories with reference to this description. If it is found that there is any accessory lost or damaged, please get in touch with our distributor responsible for this service or our local offices.

3. Check the Complete Instrument

If it is found that there is damage to the appearance of the instrument, or the instrument can not work normally, or fails in the performance test, please get in touch with our distributor responsible for this business or our local offices. If there is damage to the instrument caused by the transportation, please keep the package. With the transportation department or our distributor responsible for this business informed about it, a repairing or replacement of the instrument will be arranged by us.

Install the Batteries

The oscilloscope meter is powered by a 3.7V (18650) battery.



Warning: To avoid false readings, which could lead to possible electric shock or personal injury, please stop using and connect the device to the power supply for charging or replace the battery as soon as the low battery indicator appears.

Before replacing the battery, turn off the meter, disconnect test leads and any connectors from any circuit under test, remove test leads from the input terminals. Use only the specified battery type.

Note:When charging,disconnect test leads from the input to open the charging cover and charge the device.

Use the following procedure to install the battery:

- (1) Power off, remove test leads and any connectors from the input terminals.
- (2) Lift the tilt stand and loosen the screws with a suitable Phillips screwdriver and remove the battery cover.
- (3) Observe the battery polarity indicated inside the battery compartment, Insert the battery.
- (4) Place the battery cover back in its original position and tighten the screws.



Caution: To avoid instruments being damage from battery leakage, remove the batteries and store them separately if the oscilloscope meter is not going to be used for a long period.

Adjusting the Tilt Stand

Pull the tilt stand outward to its maximum reach (about 85° to the meter body).

Power on/off

It can be turned on in the following ways:

- Press the  button at the bottom left of the host;
- Power on automatically when plugged in;
- Power on automatically after battery installation.





Note:

After the first boot, Reset, or battery removal, you will need to configure the date and time manually. Please refer to page 17 for detailed instructions on “**System Settings**”, specifically under the **Date|Time** section.

It can be turned off in the following ways:

- Manual shutdown, tap and hold  button (when the power is connected, the shutdown will enter the standby mode);
- Automatic shutdown, emit a short beep one minute before shutdown, emit a long beep during shutdown;
- Low power automatic shutdown.

Selecting the Range

- Auto ranging is set as default when the meter is powered on, **Auto** is displayed.
- Under automatic range, press  or  to enter the manual range mode.
- Under manual range, each additional press of  sets the oscilloscope meter to the next higher range; each additional press of  sets the oscilloscope meter to the next lower range.
- Under manual range, press  to enter the auto range mode.

Note: Manual range is not available when measuring capacitance.

Measurement Connections

After selecting the desired measurement function, please connect the signal (device) under test to the oscilloscope meter according to the method below. To avoid instrument damage, do not discretionarily switch the measurement function when measuring.

DC Voltage Measurement

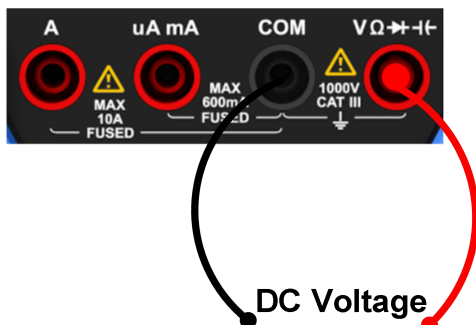

AC Voltage Measurement

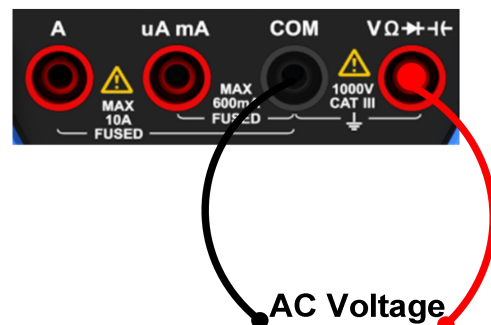

DC Current Measurement

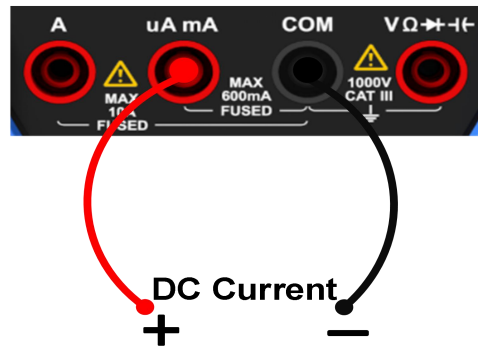
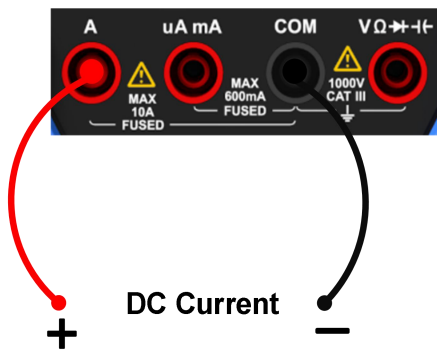

AC Current Measurement

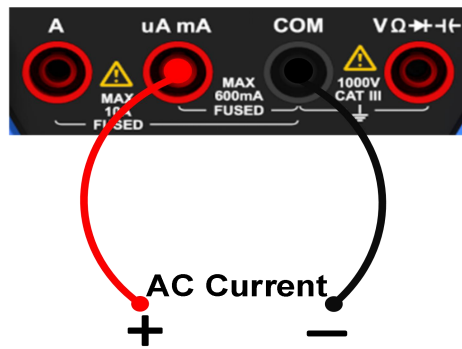
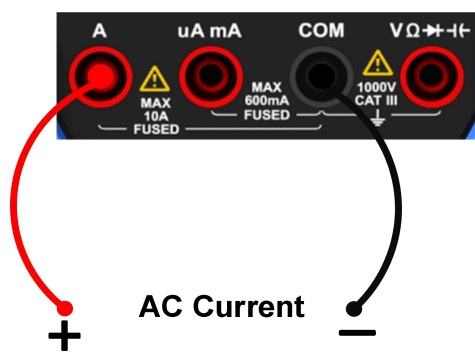

Resistance Measurement

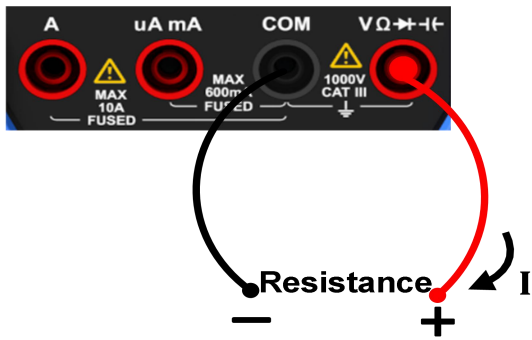

Continuity Test

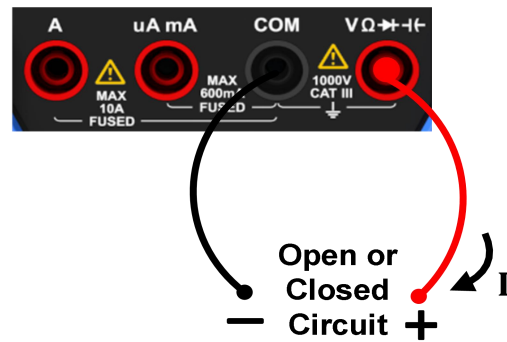

Diode Measurement

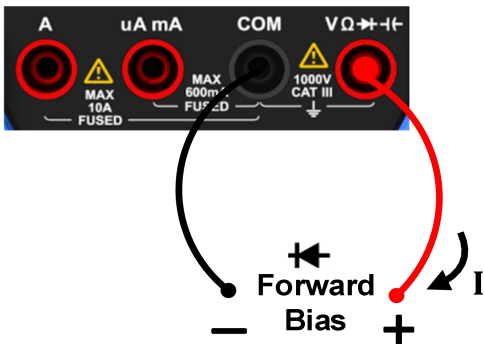

Capacitance Measurement

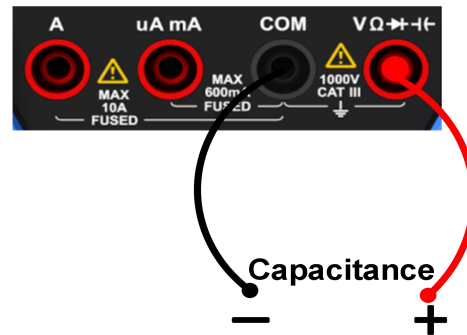

Frequency Measurement

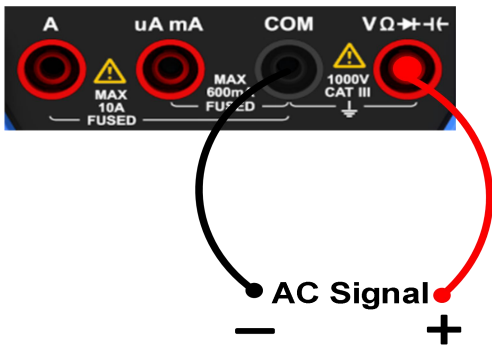





Instrument Panel

Front Panel and Keys



Figure 2-1: Front panel

Description:

Num	Illustration in multimeter mode	Illustration in oscilloscope mode
1	Display area.	
2	The F1 - F4 keys are multi-function keys. In each menu mode, press the corresponding key to select the corresponding menu item.	
3	Function key, press to select the corresponding function.	Only  and  function.
4	Comparative value key.	Trigger menu key.
5	Function of direction keys ▲ ▼: used for changing range. Function of  key: Restore auto gear.	Function of direction keys ▲ ▼: used for the amplitude scales. Function of direction keys ◀ ▶: used for zooming waveforms and the time base changing. Function of  key: Perform automatic setup.
6	Relative value key.	Trigger value key, press it will automatically setting the trigger level to half of the current signal's Vpp.
7	Enter the system settings key.	
8	Image save key.	
9	Measurement input port.	
10	Value hold key.	Stop/Run key.
11	 : Long press to turn off, short press to turn on or display the status bar.	
12	Switch key for working state of oscilloscope and multimeter.	
13	Maximum and minimum value measurement button.	Measurement value display button.

Side Panel



Figure 2-2: Side panel

Description:

1. Charging or USB communication interface(Note:The measurement input port is not available when the interface is charging or communicating).
2. Bracket.

Instrument Interface

Multimeter interface

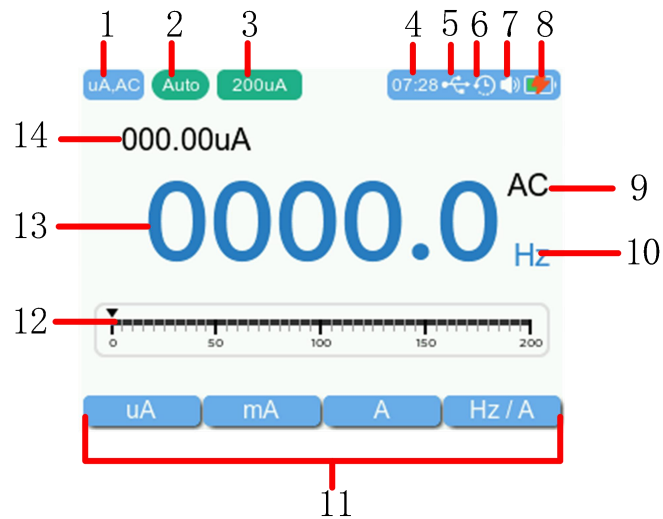

Description:

1. Measurement type indication:

Measurement type	Description
V,DC、 mV,DC	DC voltage measurement
V,AC、 mV,AC	AC voltage measurement
Res	Resistance measurement
Cont	On/Off measurement
Diode	Diode measurement
CAP	Capacitance measurement
Freq	Frequency measurement
uA,DC、 mA,DC、 A,DC	DC current measurement
uA,AC、 mA,AC、 A,AC	AC current measurement

2. Range indication: **Manual** means manual range; **Auto** means automatic range.
3. Current measurement range.
4. Time display.
5. Indicating that there is a USB cable inserted.

6. Automatic shutdown sign:Displays the flag when enabled. Closing will hide the identity.
7. Operation beep identification:Displays the flag when enabled. Closing will hide the identity.
8. Battery level and charge indication.
9. DC/AC/On-Off/Diode/Capacitance indication.
10. Main unit of measurement.
11. F1~F4 operation menu.
12. Range simulation strip.
13. Main measurement value.
14. Secondary measurement value.

Oscilloscope interface

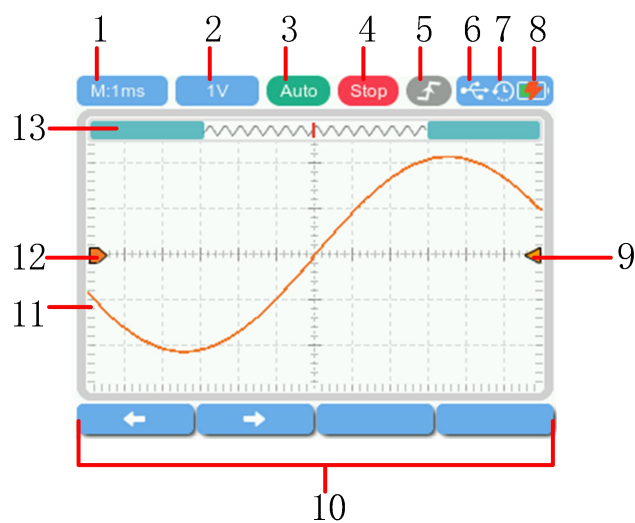

Description:

1. Time base(In the vertical direction,the per grid denotes time).
2. Amplitude(In the vertical direction,the per grid denotes voltage or current).
3. Trigger operation mode:

Auto: In this trigger mode,if the specified trigger condition is not detected, the oscilloscope will initiate a forced triggering and acquisition process to display the waveform.This triggering method is suitable for unknown signal levels or when displaying DC signals, as

well as when trigger conditions occur frequently and there is no need for forced triggering. When the base time is greater than or equal to 100 milliseconds, enter the scanning mode.

Normal: In this trigger mode, the oscilloscope only performs triggering and acquisition when the specified trigger condition is detected. This triggering method is applicable to low repetition rate signals, selective capture of specific events determined by trigger settings, and ensuring a stable display by preventing automatic triggering by the oscilloscope.

Single: In this trigger mode, the oscilloscope performs a single triggering and acquisition only when the specified trigger condition is detected, and then stops. This triggering method is suitable for situations where a single capture of a specific event is needed for subsequent analysis (enabling translation and scaling of the current displayed waveform, with subsequent waveform data not overwriting the current waveform). After a single triggering, the oscilloscope enters the "STOP" state.

4. The trigger status indicates the following information:

Trig: A trigger has been detected and post trigger information is being collected.

Ready: All pre-trigger data have been obtained and the oscilloscope is ready.

Scan: Continuously collect and display waveform data.

Stop: Stop collecting waveform data.

5. Trigger edge type.

6. It indicates that there is a USB disk connecting.

7. Automatic shutdown sign: Displays the flag when enabled. Closing will hide the identity.

8. Battery level and charge indication.

9. Trigger level horizontal position.

10. F1~F4 operation menu.

11. Waveform display area.
12. Channel waveforms.
13. Waveform scroll bar.

3. Save and Recall Picture

1. **Save picture:** Press  button will initiate the process of capturing a screenshot. Upon completion, a prompt will appear containing information about the directory where the screenshot is saved. By default, it is possible to save up to 20 screenshots, with new captures overwriting older ones once the limit is reached.





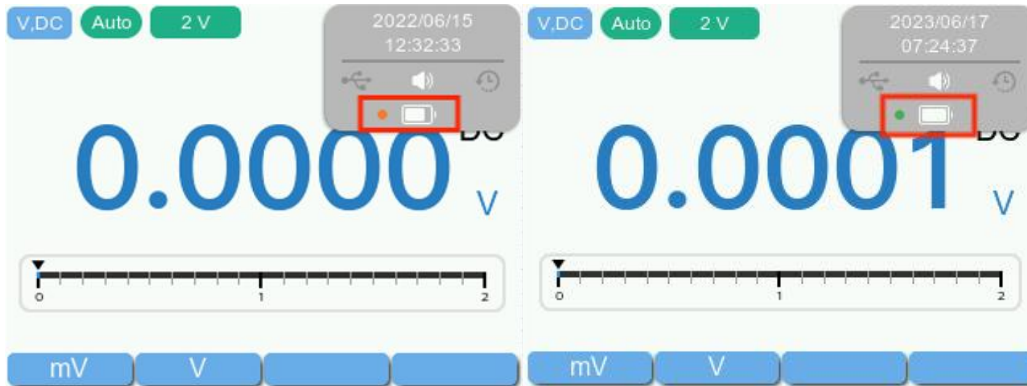

Note: The dot next to the battery will display orange if the storage space is insufficient, and it will display green if the storage space is adequate.



2. **Recall picture:** Upon connecting the USB cable to a computer, to open the saved image, select the path where the image is stored.

4. System Settings

Press  to enter the system function menu. Press  or  to select the desired function menu, and then press  or  to select desired setting.

● Date|Time





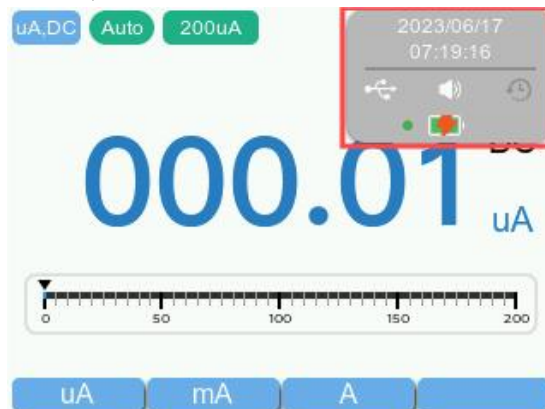

Select **Date|Time** page, you can do the following.

The description of the option is as follows:

Page options	Description
Date, Time	Set the required time.
Hour 12h	Set the display mode to 12-hour format.
Date Tran	Set the time display format.

1. Press the power button  can display the hidden time icon; press any button, can hide the date.



2. **Time setting:** Select **Date, Time** option. Press  or  to select year, month, day, hour, minute and second, and then press  or  to set required time.
3. **12-hour format setting:** Select **Hour 12h** option. Press  the time display will be in the 12-hour format and press it again will switch to 24-hour format.
4. **Date display settings:** Select **Date Tran** option. Press  the date will be displayed in the format of DD/MM/YYYY (day/month/year), and press it again, the date will be displayed in the format of YYYY/MM/DD.

- **Display**

Select **Display** page,you can do the following.

The description of the option is as follows:

Page options	Description
Dark Mode	Set the multimeter display mode
Brightness	Adjust brightness High, Mid or Low.

1. **Multimeter display mode setting:**Select **Dark Mode** option,and then press ,the "Reboot device Press again" prompt box will pop up on the screen. Pressing the  button at the same time will restart the device and apply the new display mode.Press any key to undo the action currently being performed.





2. **Brightness setting:**Select **Brightness** option,and then press ,the brightness varies between Low, Mid, and High.

- **Sound**

Select **Sound** page,you can do the following.

The description of the option is as follows:

Page options	Description
Voice	Set the key operation prompt tone.
Volume	Set the volume.
Warning	Set alarms.

1. **Voice setting:**Select **Voice** option,and then press  will produce a sound prompt;press it again will be no sound prompt upon pressing a key.
2. **Volume setting:**Select **Volume** option,press  will increase volume; press  will decrease volume.The sound is set to maximum by default.





- Warning setting:**Select **Warning** option,and then press  an alarm notification will be enabled;press it again will there will be no alarm notification(Such as: probe socket detection.).

- **System**

Select **System** page,you can do the following.

The description of the option is as follows:

Page options	Description
Auto Power Off	Set automatic shutdown.
Power Off	Set the automatic shutdown time.
Reset	Restore default setting.
About	Display information about the instrument.

- Automatic shutdown setting:**Select **Auto Power Off** option,and then press  will enable automatically shut down.When enabled, the device will automatically power off after a specified period of inactivity; pressing the button again will require manual shutdown.
- Automatic shutdown time setting:**Select **Power Off** option.Press  the shutdown time will change between 5 min and 30 min.
- Reset setting:**Select **Reset** option,and then press ,”Reset settings Press again” will pop up on screen, press  at the same time,the device will restart and restore default setting.Press any key to undo the action currently being performed..

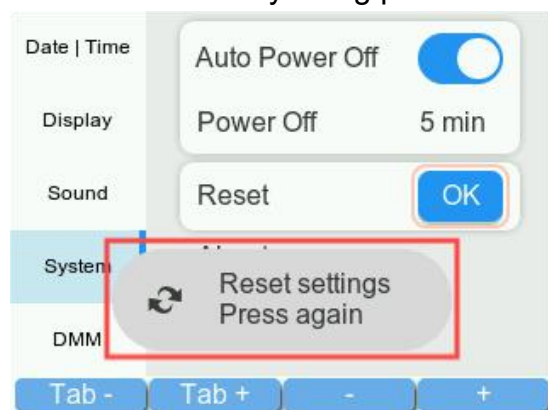



- **DMM**

Select **DMM** page,you can do the following:

The description of the option is as follows:

Page options	Description
Cont SENS	Set the on-off value(HDS120 series device can not be set).
Comp Range	Set comparison range.
Out Range Pass	Set the comparison pass condition range as outside the interval.

1. **Set on-off range:**Select **Comp Range** option, and then press  or  can modify the range of the interval (left and right intervals will be automatically determined).
2. **Set out range pass:**Select **Out Range Pass** option,and then press  to enable or disable the option.Enabling this option sets the comparison pass condition as outside the interval. Disabling this option sets the comparison pass condition as inside the interval.

5. Appendix

Appendix A: List of Accessories

- 1 set of probes
- 1 quick guide
- 1 USB-TYPEC line

Appendix B: Maintenance and Cleaning

General maintenance

Do not store or place the instrument in a place where the LCD screen will be exposed to direct sunlight for a long time.

Caution: Do not let spray, liquid or solvent touch the instrument or probe to prevent damage to the instrument or probe.

Cleaning:

Check the instrument and probe frequently according to the operation. Clean the external surface of the instrument as follows:

1. Please wipe the floating dust outside the instrument and probe with a soft cloth. When cleaning the LCD, be careful not to scratch the transparent LCD protection screen.
2. Wipe the instrument with a damp but non dripping soft cloth. Please disconnect the power supply. It can be scrubbed with soft detergent or water. Do not use any abrasive chemical cleaning agent to avoid damaging the instrument or probe.



Warning: Please make sure the instrument is dry before re-energizing to avoid electrical short circuit or personal injury caused by moisture.

Charging and Replacement of Battery

During the long-term storage of the device, the battery may be too low due to the self-discharge of the lithium battery and the device cannot be turned on. This is a normal phenomenon.

To pre-charge the device for 0.5 to 1 hour (depending on the storage time) before turning it on. In addition, if the device is not used for a long time, it is recommended to charge it at regular intervals to avoid over-discharge of the lithium battery.

Battery Charging

The lithium battery may not be fully charged when delivered. The power supply and battery indicator symbols in the upper right corner of the screen are explained as follows:

Model	Charging	Discharging
120 series device	≥2.5 hour	≥24 hour

 symbol indicates the power-on charging status;

 symbol indicates battery power supply;

 symbol indicates that there is only about five minutes of use time left.

Please charge as soon as possible according to the relevant tips to avoid damage to the battery.

Charging Method

Connect the oscilloscope meter to a computer or other equipment through a USB data cable for charging (pay attention to the load capacity of the power supply equipment to avoid abnormal operation of the equipment).

Note

To avoid overheating of the battery during charging, the ambient temperature must not exceed the allowable value given in the technical specifications.

Replacement of Lithium Battery

Generally, the battery does not need to be replaced. However, when necessary, it can only be replaced by qualified personnel, and only **lithium batteries of the same specification** can be used.