

# Table of Contents

<b>1. Introduction</b>	7
Step 1 - All the required tools are included	8
Step 2 - Additional utilities for this guide	8
Step 3 - Labels guide	9
Step 4 - Spare bag	9
Step 5 - View high resolution images	10
Step 6 - Printed parts - versioning	10
Step 7 - We are here for you!	11
Step 8 - Pro tip: inserting the nuts	12
Step 9 - Important: Electronics protection	13
Step 10 - Reward yourself	14
Step 11 - How to successfully finish the assembly	15
Step 12 - Additional Information	16
Step 13 - Prepare your desk	16
<b>2. Frame assembly</b>	17
Step 1 - Tools necessary for this chapter	18
Step 2 - YZ frame: parts preparation	18
Step 3 - YZ frame: mounting the longer extrusions	19
Step 4 - YZ frame: mounting the shorter extrusions	20
Step 5 - YZ frame: final check	20
Step 6 - Y-axis: front and rear plate preparation	21
Step 7 - Y-axis: front plate assembly	21
Step 8 - Y-axis: rear plate assembly	22
Step 9 - Y-axis: preparation for the xBuddy box	22
Step 10 - Y-axis: preparation for the PSU	23
Step 11 - Y-axis: geometry check	23
Step 12 - Mounting antivibration feet and cable clips: parts preparation	24
Step 13 - Mounting antivibration feet	24
Step 14 - Installing the cable clip	25
Step 15 - Installing the cable clips	25
Step 16 - PSU: parts preparation	26
Step 17 - Attaching the PSU	26
Step 18 - Securing the PSU	27
Step 19 - xBuddy box: parts preparation	28
Step 20 - Mounting the xBuddy box: parts preparation	28
Step 21 - Mounting the xBuddy box: inserting screws	29
Step 22 - Attaching the xBuddy box	29
Step 23 - Securing the xBuddy box	30
Step 24 - Applying the thermal pads	30
Step 25 - Mounting the xBuddy board	31
Step 26 - Attaching the zip ties	32
Step 27 - Y-belt-idler: parts preparation	32
Step 28 - Assembling Y-belt-idler	33
Step 29 - Mounting the Y-belt-idler	33
Step 30 - Assembling the Y motor: parts preparation	34
Step 31 - Assembling the Y motor	34
Step 32 - Assembling the Y-motor-holder	35
Step 33 - Adjusting the Y-motor pulley	35
Step 34 - Attaching the Y-motor-holder	36
Step 35 - Haribo	37

Step 36 - It's done!	37
<b>3. X-axis &amp; X-carriage assembly</b>	<b>38</b>
Step 1 - Tools necessary for this chapter	39
Step 2 - X-axis assembly: parts preparation	39
Step 3 - Assembling the X-end-motor (part I)	40
Step 4 - Assembling the X-end-motor (part II)	40
Step 5 - Assembling the X-end-idler (part I)	41
Step 6 - Assembling the X-end-idler (part II)	41
Step 7 - Assembling the X-end-idler (part III)	42
Step 8 - Mounting the bearings: parts preparation	42
Step 9 - Inserting the bearings: bearing pads	43
Step 10 - Inserting the bearings: bearing clips	43
Step 11 - Covering the bearings: X-end-motor	44
Step 12 - Inserting the bearings: X-end-idler	44
Step 13 - Assembling the X-axis: parts preparation	45
Step 14 - Assembling the X-axis: Marking the bearings	45
Step 15 - Assembling the X-axis: Inserting smooth rods	46
Step 16 - Assembling the X-axis: mounting the X-end-motor	46
Step 17 - Assembling the X-carriage: parts preparation	47
Step 18 - Assembling the X-carriage	47
Step 19 - Attaching the spacers	48
Step 20 - Securing the spacers	48
Step 21 - Assembling the X-carriage-clip: parts preparation	49
Step 22 - Assembling the X-carriage-clip	49
Step 23 - Attaching the X-carriage-clip	50
Step 24 - Attaching the X motor: parts preparation	51
Step 25 - Attaching the X motor	51
Step 26 - Attaching the X motor: mounting the pulley	52
Step 27 - Guiding the X belt: parts preparation	52
Step 28 - Guiding the X belt: X-end-idler	53
Step 29 - Guiding the X belt: X-end-motor	53
Step 30 - Guiding the X belt: X-carriage	54
Step 31 - Assembling the X-carriage: final check	54
Step 32 - Haribo	55
Step 33 - It's done!	55
<b>4. Z-axis assembly</b>	<b>56</b>
Step 1 - Tools necessary for this chapter	57
Step 2 - Assembling the Z-bottoms: parts preparation	57
Step 3 - Inserting the rods	58
Step 4 - Assembling the Z-bottoms	58
Step 5 - Z motor assembling: parts preparation	59
Step 6 - Attaching the rubber pads	59
Step 7 - Installing the Z motors	60
Step 8 - Connecting the Z motors	60
Step 9 - Mounting the X-axis assembly: parts preparation	61
Step 10 - Assembling the X-axis and smooth rods	61
Step 11 - Installing the X-axis assembly	62
Step 12 - Assembling the trapezoidal nuts	62
Step 13 - Installing the Z-top parts: parts preparation	63
Step 14 - Placing the Z-top parts	63
Step 15 - LoveBoard: parts preparation	64
Step 16 - Assembling the LoveBoard	64
Step 17 - Connecting the extruder main cable	65
Step 18 - Mounting the extruder main cable	65

Step 19 - Connecting the extruder main cable: parts preparation .....	66
Step 20 - Connecting the extruder main cable .....	66
Step 21 - Covering the X-carriage: parts preparation .....	67
Step 22 - Covering the X-carriage: inserting the nylon filament .....	67
Step 23 - Attaching the X-cover-back .....	68
Step 24 - Guiding the main-cable: parts preparation .....	68
Step 25 - Wrapping the extruder main cable .....	69
Step 26 - Wrapping the textile sleeve .....	69
Step 27 - Attaching the Ext-cable-holder: parts preparation .....	70
Step 28 - Wrapping the X motor cable .....	70
Step 29 - Attaching the Ext-cable-holder .....	71
Step 30 - Assembling the Ext-cable-holder .....	71
Step 31 - Covering the Ext-cable-holder .....	72
Step 32 - Mounting the Ext-cable-holder .....	72
Step 33 - Reward yourself! .....	73
Step 34 - Here it is! .....	73
<b>5. Nextruder assembly .....</b>	<b>74</b>
Step 1 - Tools necessary for this chapter .....	75
Step 2 - Nextruder idler assembly: parts preparation .....	75
Step 3 - Assembling the extruder idler .....	76
Step 4 - Assembling the extruder: parts preparation I. ....	76
Step 5 - Assembling the extruder: parts preparation II. ....	77
Step 6 - Assembling the extruder .....	77
Step 7 - Assembling the gearbox .....	78
Step 8 - Assembling the PG-ring .....	78
Step 9 - Assembling the PG-assembly .....	79
Step 10 - Checking the PG-assembly .....	79
Step 11 - Assembling the Nextruder idler .....	80
Step 12 - Gear lubrication: parts preparation .....	80
Step 13 - Lubricating the gear .....	81
Step 14 - Covering the planetary gear .....	81
Step 15 - Assembling the Idler-swivel: parts preparation .....	82
Step 16 - Assembling the Idler-swivel .....	82
Step 17 - Assembling the Idler-nut .....	83
Step 18 - Mounting the Idler-swivel assembly .....	83
Step 19 - NTC thermistor & fan holder: parts preparation .....	84
Step 20 - Assembling the NTC thermistor .....	84
Step 21 - Assembling the Nextruder .....	85
Step 22 - Attaching the Nextruder .....	85
Step 23 - Connecting the NTC thermistor .....	86
Step 24 - Assembling the hotend fan: parts preparation .....	86
Step 25 - Assembling the hotend fan .....	87
Step 26 - Print fan blower: parts preparation .....	87
Step 27 - Assembling the print fan case .....	88
Step 28 - Assembling the print fan blower .....	88
Step 29 - Assembling the fan shroud .....	89
Step 30 - Mounting the print fan blower assembly .....	89
Step 31 - Connecting the print fan blower .....	90
Step 32 - Inserting the hotend assembly: parts preparation .....	90
Step 33 - Inserting the hotend assembly .....	91
Step 34 - Nozzle insertion check .....	91
Step 35 - Connecting the hotend cables .....	92
Step 36 - Fan door cover: parts preparation .....	92
Step 37 - Attaching the Fan-door-cover .....	93

Step 38 - Connecting the extruder cables .....	93
Step 39 - LoveBoard: Wiring check .....	94
Step 40 - Covering the LoveBoard: parts preparation .....	94
Step 41 - Covering the LoveBoard: side cover .....	95
Step 42 - Covering the LoveBoard: top cover .....	95
Step 43 - Tensioning the X-axis belt .....	96
Step 44 - Belt tension check .....	97
Step 45 - Testing the X-axis belt .....	97
Step 46 - Haribo time! .....	98
Step 47 - The extruder is assembled .....	98
<b>6. xLCD assembly .....</b>	<b>99</b>
Step 1 - Tools necessary for this chapter .....	100
Step 2 - xLCD assembly: parts preparation (part 1) .....	100
Step 3 - xLCD assembly: parts preparation (part 2) .....	101
Step 4 - Installing the xReflector sticker .....	101
Step 5 - Covering the xLCD .....	102
Step 6 - Installing the PE Faston .....	102
Step 7 - xLCD cables: parts preparation .....	103
Step 8 - Connecting the xLCD cable & PE cable .....	103
Step 9 - Attaching the knob .....	104
Step 10 - Attaching the xLCD assembly .....	104
Step 11 - Connecting the PSU: parts preparation .....	105
Step 12 - Connecting the PSU: PE cable .....	105
Step 13 - Power cables info .....	106
Step 14 - Connecting the PSU (part 1) .....	107
Step 15 - Connecting the PSU (part 2) .....	107
Step 16 - Connecting the power panic .....	108
Step 17 - Guiding the Z motor right cable .....	108
Step 18 - Guiding the power cable bundle .....	109
Step 19 - Guiding the power cables .....	109
Step 20 - Connecting the X and Y motor cables .....	110
Step 21 - Connecting the PSU cable: parts preparation .....	110
Step 22 - Connecting the PSU cables: PE cable .....	111
Step 23 - Connecting the PSU cables: .....	111
Step 24 - Securing the PSU cables .....	112
Step 25 - Guiding the Z motor left cable .....	112
Step 26 - Connecting the xLCD cables .....	113
Step 27 - Connecting the extruder main cable .....	113
Step 28 - Time for energy delivery! .....	114
Step 29 - Almost there! .....	114
<b>7. Y-carriage &amp; Heatbed assembly .....</b>	<b>115</b>
Step 1 - Tools necessary for this chapter .....	116
Step 2 - Heatbed cable assembly: parts preparation .....	117
Step 3 - Heatbed cable assembly (part 1) .....	117
Step 4 - Heatbed cable assembly (part 2) .....	118
Step 5 - Heatbed cable assembly (part 3) .....	118
Step 6 - Covering the heatbed cables: parts preparation .....	119
Step 7 - Assembling the heatbed-cable-cover-bottom .....	119
Step 8 - Assembling the heatbed-cable-cover: nylon filament .....	120
Step 9 - Assembling the heatbed-cable-cover-bottom .....	120
Step 10 - Assembling the heatbed-cable-cover-top .....	121
Step 11 - Wrapping the textile sleeve .....	121
Step 12 - Y-carriage: parts preparation .....	122
Step 13 - Assembling the bearing clips .....	122

Step 14 - Installing the bearing on the Y-carriage .....	123
Step 15 - Aligning the bearing .....	123
Step 16 - Installing the bearings on the Y-carriage .....	124
Step 17 - Positioning of the bearings .....	124
Step 18 - Y-axis: smooth rods holders .....	125
Step 19 - Inserting smooth rods into Y-carriage .....	125
Step 20 - Preparing Y-rod-holder .....	126
Step 21 - Mounting the Y-rod-holder parts .....	126
Step 22 - Installing the Y-carriage .....	127
Step 23 - Aligning the smooth rods .....	127
Step 24 - Assembling the Y belt: parts preparation .....	128
Step 25 - Assembling the Y-belt-holder .....	128
Step 26 - Assembling the Y belt .....	129
Step 27 - Attaching the Y belt holder .....	129
Step 28 - Assembling the Y belt tensioner .....	130
Step 29 - Attaching the Y belt tensioner .....	130
Step 30 - Tensioning the Y belt .....	131
Step 31 - Belt tension check .....	131
Step 32 - Aligning the Y belt .....	132
Step 33 - Installing the Expansion joints: parts preparation .....	132
Step 34 - Preparing the expansion joints .....	133
Step 35 - Installing the Expansion joints .....	133
Step 36 - Attaching the heatbed: parts preparation .....	134
Step 37 - Attaching the heatbed .....	134
Step 38 - Tightening the heatbed .....	135
Step 39 - Guiding the heatbed cables: parts preparation .....	135
Step 40 - Assembling the Wi-Fi .....	136
Step 41 - Guiding the heatbed cables .....	136
Step 42 - Installing the WiFi cover assembly .....	137
Step 43 - NFC antenna: parts preparation I. ....	138
Step 44 - NFC antenna: parts preparation II. ....	138
Step 45 - Connecting the NFC antenna .....	139
Step 46 - Preparing the NFCcoil .....	140
Step 47 - Assembling the NFC antenna .....	140
Step 48 - Verify all connections once more! .....	141
Step 49 - Covering the xBuddy box: bottom cover .....	141
Step 50 - Covering the xBuddy box .....	142
Step 51 - Assembling the double spool holder (part 1) .....	142
Step 52 - Assembling the double spool holder (part 2) .....	143
Step 53 - Assembling the Filament guide: parts preparation .....	143
Step 54 - Filament guide assembly (part 1) .....	144
Step 55 - Filament guide assembly (part 2) .....	144
Step 56 - Haribo time! .....	145
Step 57 - That's it .....	145
<b>8. Preflight check .....</b>	<b>146</b>
Step 1 - Attaching the steel sheet .....	147
Step 2 - First run .....	147
Step 3 - Printer setup .....	148
Step 4 - Network setup: Wi-Fi connection (Optional) .....	149
Step 5 - Network setup: Prusa Connect (Optional) .....	150
Step 6 - Wizard - Selftest start .....	151
Step 7 - Wizard - Loadcell Test .....	151
Step 8 - Wizard - Gearbox Alignment .....	152
Step 9 - Wizard - Filament Sensor Calibration .....	152

Step 10 - Wizard complete .....	153
Step 11 - Reward yourself! .....	153
Step 12 - Loading a filament .....	154
Step 13 - Printable 3D models .....	154
Step 14 - Firmware update .....	155
Step 15 - PrusaSlicer for MK4S .....	155
Step 16 - PrusaLink & Prusa Connect .....	156
Step 17 - Quick guide for your first prints .....	156
Step 18 - Prusa knowledge base .....	157
Step 19 - Join Printables! .....	157
<b>Manual changelog</b> .....	<b>158</b>
Step 1 - Version history .....	159

# 1. Introduction



## STEP 1 All the required tools are included

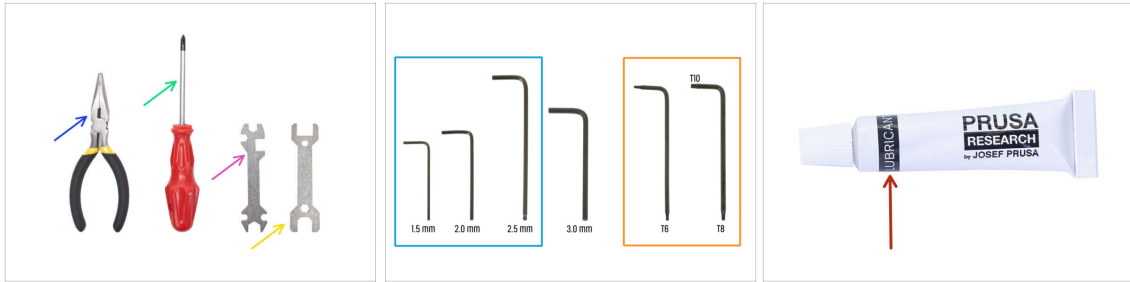

● The tool package can be found in the Fasteners & ELE box. The tool package includes:

- Needle-nose pliers (1x)
- Philips (PH2) screwdriver (1x)
- Universal wrench (1x)
- Wrench size 13 mm (1x)
- Allen key set
- Torx key set
- Lubricant (*included in Fasteners & ELE box*)

## STEP 2 Additional utilities for this guide



● Some steps in the manual will require commonly available items to help you with assembly (not included in the kit):

- Scissors - *For cutting a bag with bearings*
- Permanent marker - choose black or another dark color. *The marker will come in handy a few chapters further, for marking bearings and magnets.*
- Paper towels or piece of cloth - *For wiping residual grease off the bearings and smooth rods and as a soft pad for preparing the Y-carriage assembly.*

ⓘ No soldering or wire crimping is required.



## STEP 3 Labels guide

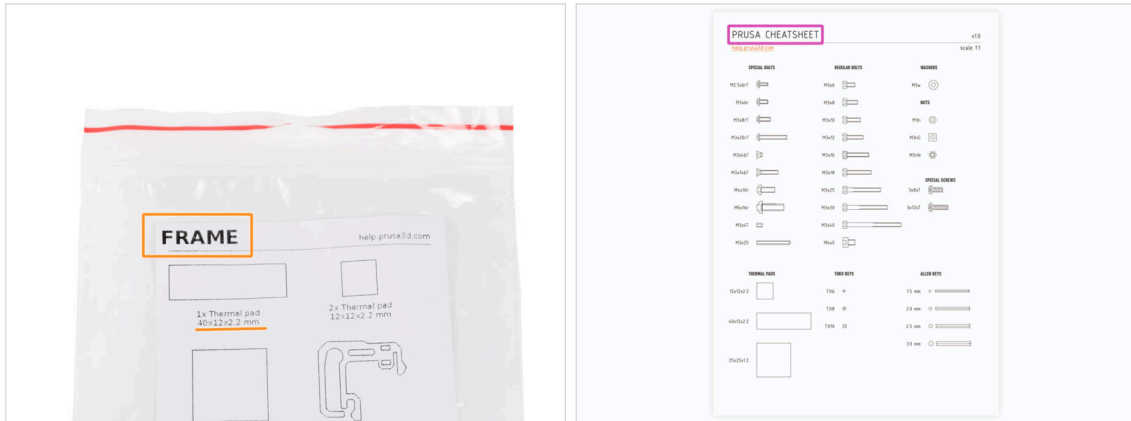

- All the boxes and bags including parts for the build are labeled.
- The labels include the list of contents and part count.
- You can download a **Cheatsheet** with 1:1 fastener drawings from our site [prusa.io/cheatsheet-mk4s](https://prusa.io/cheatsheet-mk4s). Print it at 100 %, don't rescale it, otherwise, it won't work.
- ⓘ For PRUSA veterans: Fasteners are divided into individual bags according to its type. Not into packages for individual chapters, as it was with previous printers.

## STEP 4 Spare bag



- There is a bag with spare parts like thermal pads, springs, etc.
- Spare fasteners are included in each bag of fasteners. The amount of spare is always included in the total number shown on the bag.

## STEP 5 View high resolution images



- ◆ When you browse the guide on [help.prusa3d.com](https://help.prusa3d.com), you can view the original images in high resolution for clarity.
- ◆ Just hover your cursor over the image and click the Magnifier button ("View original") in the top left corner.

## STEP 6 Printed parts - versioning



- ◆ Most of the 3D printed parts on Original Prusa MK4S are marked with their version.
  - ◆ **E, F and Gx series** (e.g. E1) - those parts are printed on Prusa Research farm and are distributed with the kit.
  - ◆ **R, S and Tx series** (e.g. R1) - those parts are available for download at [prusa.io/printable-parts-mk4s](https://prusa.io/printable-parts-mk4s). They are identical to the factory ones.
- ⓘ In case you have issues while assembling the printer with the certain printed part, please try to find this label and tell it to our support team.

## STEP 7 We are here for you!

**3. Frame assembly**

**3. X-axis & X-carriage assembly**

**4. Z-axis assembly**

**5. Nextuder assembly**

- 1. Tools necessary for this chapter
- 2. Filament sensor parts preparation
- 3. Assembling the filament sensor
- 4. Assembling the filament sensor
- 5. Nextuder idler assembly: parts preparation
- 6. Assembling the extruder idler
- 7. Assembling the extruder: parts preparation I
- 8. Assembling the extruder: parts preparation II
- 9. Assembling the extruder
- 10. Assembling the gear
- 11. Assembling the planetary gear
- 12. Assembling the planetary gear
- 13. Assembling the Nextuder idler
- 14. Covering the planetary gear
- 15. Assembling the idler set: parts preparation

**Step 13 Assembling the Nextuder idler**

- Insert the idler assembly between the PG-ring and the extruder motor. There is a cutout for the spacer in the main-plate. Line up the idler spacer with the hole in the PG-ring.
- Secure both parts with grub screw 3x25. Do not overtighten the screw! The grub screw protrudes from the PG-ring after tightening.
- Apply a small amount of Prusa Lubricant all around the PG-ring and PG-assembly teeth.
- Tip: apply a small amount of lubricant to the tip of the zip tie and then spread the lubricant over the gears.
- Using a paper towel, wipe off any excess lubricant on the front surfaces.

Secure both parts with grub screw 3x25. Do not overtighten the screw! The grub screw protrudes from the PG-ring after tightening.

Apply a small amount of Prusa Lubricant all around the PG-ring and PG-assembly teeth.

Tip: apply a small amount of lubricant to the tip of the zip tie and then spread the lubricant over the gears.

Using a paper towel, wipe off any excess lubricant on the front surfaces.

Apply a small amount of Prusa Lubricant all around the PG-ring and PG-assembly teeth.

Tip: apply a small amount of lubricant to the tip of the zip tie and then spread the lubricant over the gears.

Using a paper towel, wipe off any excess lubricant on the front surfaces.

2 comments

POWERED BY TINY

SUBMIT

Chat now

- 🛡️ Lost in the instructions, missing screw or cracked printed part? **Let us know!**
- 🛡️ You can contact us using the following channels:
  - 🟢 Using comments under each step.
  - 🟡 Using our 24/7 live chat here at [help.prusa3d.com](https://help.prusa3d.com)
  - 🛡️ Writing an email to [info@prusa3d.com](mailto:info@prusa3d.com)

**STEP 8** Pro tip: inserting the nuts

- 3D printed parts are very precise, however, there still might be a tolerance in the printed part and the same goes for the size of the nut.
- Therefore it might happen, that the nut won't fit easily in or might be falling out. Let's see, how to fix it:
  - **Nut won't fit in:** use a screw with a thread along its entire length (typically: M3x10, M3x18) and screw it from the opposite side of the opening. While tightening the screw, the nut will be pulled in. Remove the screw afterwards.
  - **Alternative option:** you can use X-holder tool included in the package. Insert any screw (typically: M3x10 or M3x18) and screw the nut fully on the tip of the thread. Push the nut into the printed part and remove the screw with X-holder.
  - **Nut keeps falling out:** Use a piece of tape to fix the nut temporarily in place, as soon as you insert the screw in, you can remove the tape. *Using glue isn't recommended as it can partly reach into the thread and you won't be able to tighten the screw properly.*
- Every time we recommend using the "screw pulling technique", you will be reminded with Joe's avatar ;)
- ⓘ Parts in the pictures are used as an example.

## STEP 9 Important: Electronics protection

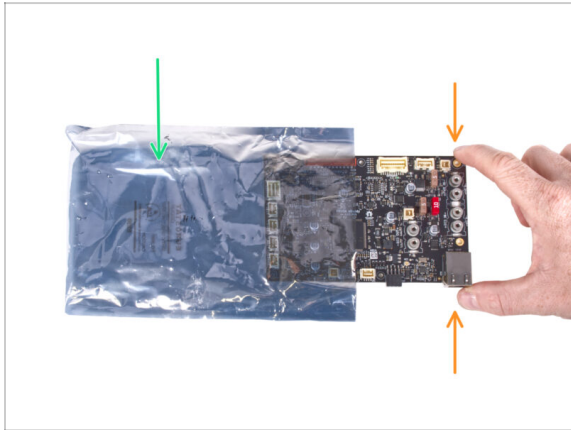

**⚠ WARNING:** Make sure to **protect the electronics against electrostatic discharge (ESD)**. Always unpack the electronics right before you need them!

● Here are some **tips to prevent damage to the electronics:**

- **Keep the electronics inside the ESD bag** right until you are asked to install them.
- **Always touch the sides of the board only** while handling it. Avoid touching the components on the surface.
- **Before you touch the electronics** use any conductive (metal) structure nearby to neutralize the possible static charge from your hands.
- Be extra cautious **in rooms with carpets**, which are often a source of electrostatic energy.
- Clothes made of wool or certain synthetic fabrics can easily gather static electricity too. It is safer to wear cotton clothing for the assembly.



## STEP 10 Reward yourself



- ◆ Based on the feedback, building the MK4S printer is even more enjoyable compared to the MK4. However, you should still treat yourself for every finished chapter. Look in the box and find a bag of Haribo Bears.
- ⚠ **The biggest issue from our experience (MK4, MK3S+, MK3S, MK3, MK2S, ...) is inadequate bear consumption. Many of you didn't have enough gummy bears for all chapters, some even ate them all before they started!**
- ◆ After years of thorough scientific research, we came to a solution => At the end of each chapter, you will be told a specific amount of bears to consume.
- ◆ Eating an incorrect amount than prescribed in the manual might lead to a sudden boost of energy. Please consult a professional in the closest candy store.
- ⚠ **Hide the Haribo for now! From our experience, an unattended bag with sweets will suddenly disappear. Confirmed by multiple cases all around the World.**

## STEP 11 How to successfully finish the assembly

**Step 25** Attaching the spacers

- Insert two M3n nuts to the X-carriage-back.
- ① Use the screw pulling technique.
- From the opposite side, insert the M3x10 screw into the X-carriage-back. The screw must protrude from the "front" side of the part.
- Attach the spacer 10 mm on the M3x10 screw and tighten the screw. **Note the cutout of the same shape as the spacer. It must fit perfectly and must not rotate.**



2 comments

 **To successfully finish the MK4S kit please follow all these:**

- ◆ **Always read all the instructions at the current step first**, it will help you to understand what you need to do. Don't cut or trim unless you are told to!!!
- ◆ **Don't follow pictures only!** It is not enough, the written instructions are as brief as they could be. **Read them!**
- ◆ Read the comments from the other users, they are great sources of ideas. We read them too and based on your feedback improved the manual and the entire assembly.
- ◆ **Use a reasonable force**, the printed parts are tough, but not unbreakable. If it doesn't fit, check your approach twice.
- ◆ **Eat the gummy bears as instructed!** Disobedience won't be tolerated :D
- ◆ **Most importantly: Enjoy the build, and have fun.** Cooperate with your kids, friends or partners.

## STEP 12 Additional Information



- i** This information applies to users planning to install accessories, such as the Original Prusa Enclosure, or upgrades like the MMU3.
- Before installing any accessories, it's essential to **assemble and test your printer according to the instructions**. Once the printer is fully functional, follow the separate MMU3 or Enclosure assembly manual to modify the printer for installation.

## STEP 13 Prepare your desk



- **Tidy up your desk!** Tidying up decreases the probability of losing small parts.
- **Clear your workspace.** Make sure you have enough room. A nice clear flat workbench will get you the results you are aiming for.
- **Let there be light!** Make sure you are in a well-lit environment. Another lamp or even an extra flashlight will probably come in handy.
- Prepare something to contain the plastic bags and the removed packing materials so you can recycle them afterwards. Make sure there are no important parts being discarded.
- OK, we are ready. Let's start! Go to chapter **2. Frame assembly**



## 2. Frame assembly



## STEP 1 Tools necessary for this chapter

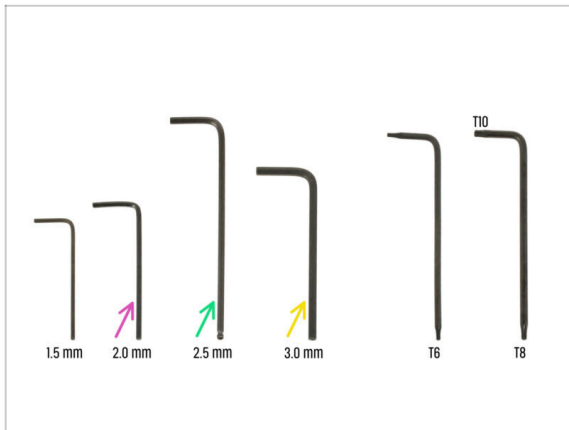

● **For this chapter, please prepare:**

- 2.0mm Allen key for tightening the grub screws
- 2.5mm Allen key for most of the M3 screws on the assembly
- 3mm Allen key for M5 screws used on the frame

## STEP 2 YZ frame: parts preparation

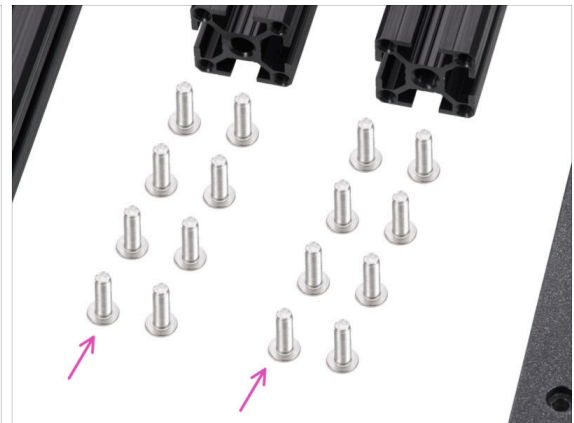
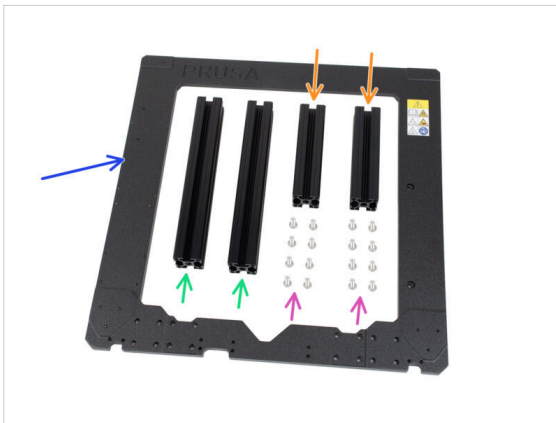

● **Prepare the following parts to build the YZ frame:**

- Extrusion 3030 120 mm (2x)
- Extrusion 3030 205 mm (2x)
- Printer frame (1x)
- M5x16r screw (16x)

⚠ **Before you proceed further, please place the frame on a flat surface.**

### STEP 3 YZ frame: mounting the longer extrusions

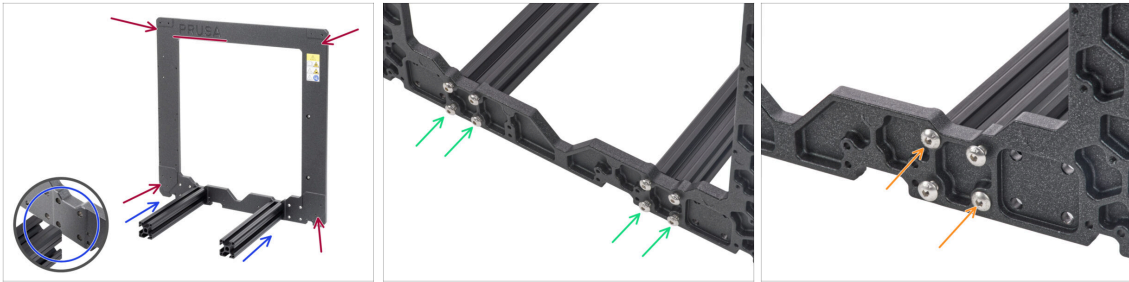

- ◆ Take the **LONGER** extrusions and place them next to the frame.
- ⚠ **Make sure the engraved PRUSA logo (top left) on the frame is visible. This is the front side. The longer extrusions are going to be mounted to the front side.**
- ⓘ Note: screws are inserted from the opposite side of the frame. If you need to manipulate with the frame, make sure the extrusions are on the correct side once again.
- Ensure you are using the correct **holes closer to the center** of the frame, see the second picture. Use the M5 screws to connect extrusions to the frame. Tighten the screws with the 3mm Allen key just slightly!
- Now, tighten the screws fully, but **IN A DIAGONAL PATTERN**, see the last picture. As soon as you finish tightening the first diagonal pair, tighten the second pair. Then proceed to the other long extrusion.
- ⚠ **Be cautious when tightening these screws to avoid damaging the Allen key slot. Ensure the Allen key is fully inserted into the screw head. Tighten the screw firmly but gently.**

## STEP 4 YZ frame: mounting the shorter extrusions

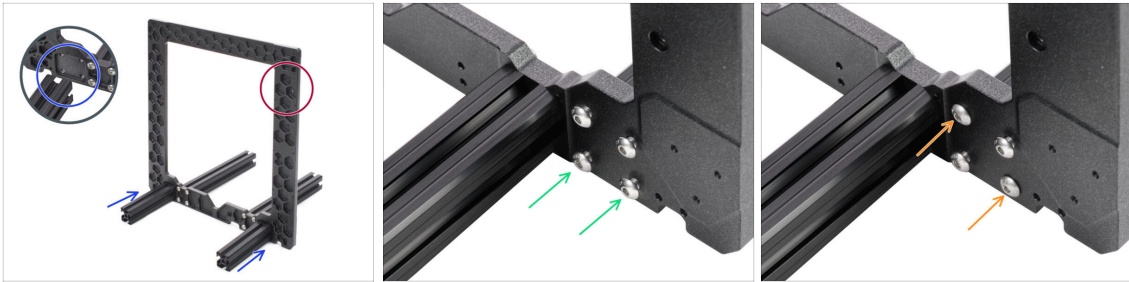

- ◆ Take the **SHORTER** extrusions and place them next to the frame.
- ⚠ **Short extrusions must be placed on the side with the hexagonal recesses.**
- ⓘ Note: screws are inserted from the opposite side of the frame. If you need to manipulate with the frame, make sure the extrusions are on the correct side.
- ◆ Ensure you are using the correct holes, see the second picture. Use the M5x16r screws to connect extrusions to the frame. Tighten the screws just slightly!
- ◆ Now, tighten the screws fully, but **IN A DIAGONAL PATTERN**, see the last picture. As soon as you finish the first diagonal pair, tighten the other screws. Then proceed to the last short extrusion.
- ⚠ **Be cautious when tightening these screws to avoid damaging the Allen key slot. Ensure the Allen key is fully inserted into the screw head. Tighten the screw firmly but gently.**

## STEP 5 YZ frame: final check



- ⚠ Before we proceed further, let's make a final check. **IT IS VERY IMPORTANT** to have extrusions on the correct side of the frame.
- ◆ **Long extrusions** - must be mounted to the side of the frame **with the Prusa logo**. Also ensure longer extrusions are **closer together**.
- ◆ **Short extrusions** - must be on the other side of the frame **without the Prusa logo**. Also ensure shorter extrusions are **further away from each other**.

## STEP 6 Y-axis: front and rear plate preparation

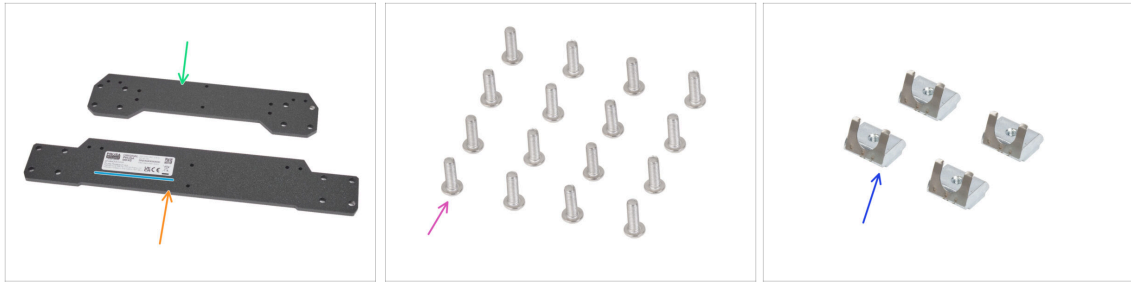

◆ For the following steps, please prepare:

- ◆ Front plate (1x)
- ◆ Rear plate (1x)
- ◆ There is a silver label with serial number on the rear plate. Keep it in mind, we use it as a guide to orient the part later on. **Do not remove the label!**
- ◆ M5x16r screw (16x)
- ◆ M3nEs nuts (4x)

## STEP 7 Y-axis: front plate assembly

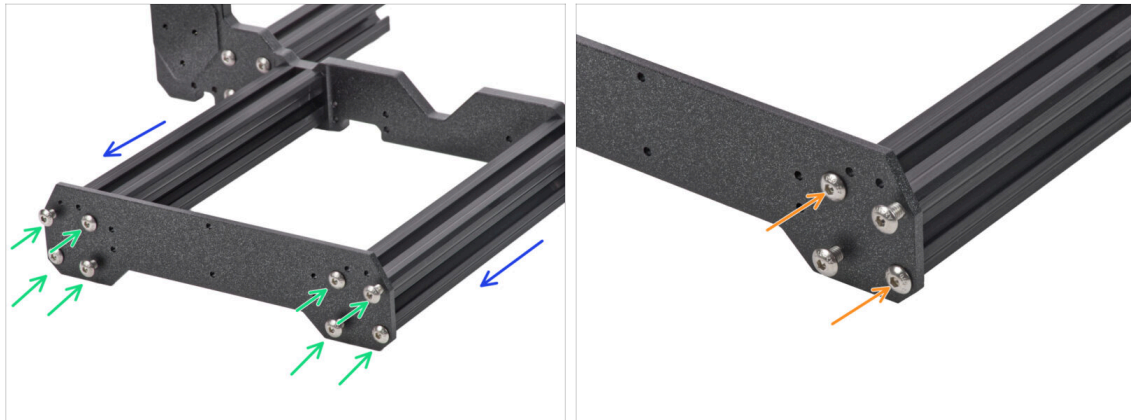

- ◆ Rotate the frame so the longer extrusions are facing towards you.
- ◆ Place the front plate (the shorter one) onto the extrusions and secure it with M5x16r screws, **DON'T TIGHTEN** them yet!
- ◆ Now, tighten the screws fully, but **IN A DIAGONAL PATTERN**, see the second picture. As soon as you finish the first diagonal pair, tighten the second pair. Then proceed to the other long extrusion.

⚠ **Be cautious when tightening** these screws to avoid damaging the Allen key slot. **Ensure the Allen key is fully inserted into the screw head. Tighten the screw firmly but gently.**

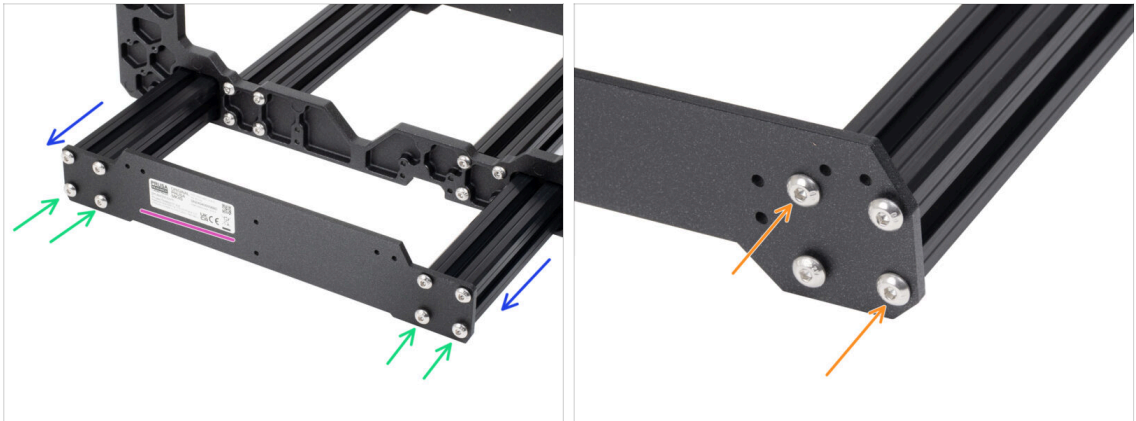
**STEP 8** Y-axis: rear plate assembly

- Ensure the side of the frame with the shorter extrusions is still facing you.
- Place the rear plate onto the extrusions and secure it with M5x16r screws, **DON'T TIGHTEN** them yet!
- Orient the part so that the sticker is on the back of the printer.
- Now, tighten the screws fully, but **IN A DIAGONAL PATTERN**, see the second picture. As soon as you finish the first diagonal pair, tighten the second pair. Then proceed to the other extrusion.

⚠ **Be cautious when tightening** these screws to avoid damaging the Allen key slot. **Ensure the Allen key is fully inserted into the screw head. Tighten the screw firmly but gently.**

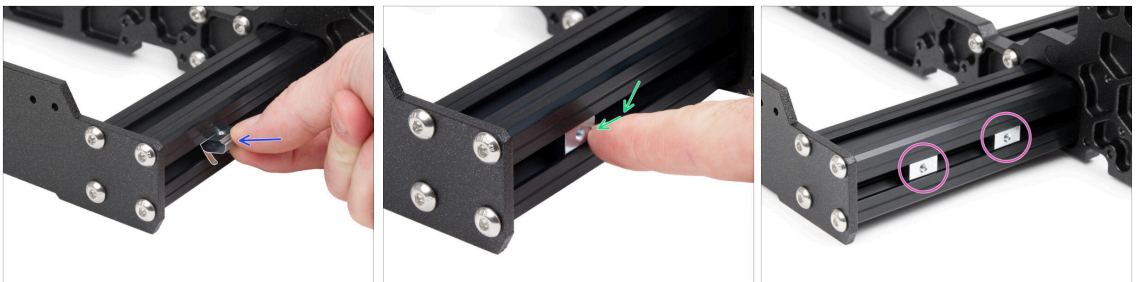
**STEP 9** Y-axis: preparation for the xBuddy box

- Insert the M3nEs nut into the left short extrusion (side without the PSU). Insert the side with the spring (metal plate) first.
- Orient the nut with the metal spring facing down.
- Push the entire nut inside the extrusion using your finger.
- Use this method for both M3nEs nuts. The exact position of the nuts doesn't matter at this time.

## STEP 10 Y-axis: preparation for the PSU



- Turn the printer with the right short extrusion facing you.
- Following the same procedure as in the previous step, insert two M3nEs nuts into the short extrusion profile.
- ⓘ The exact position of the nuts doesn't matter at this time.

## STEP 11 Y-axis: geometry check

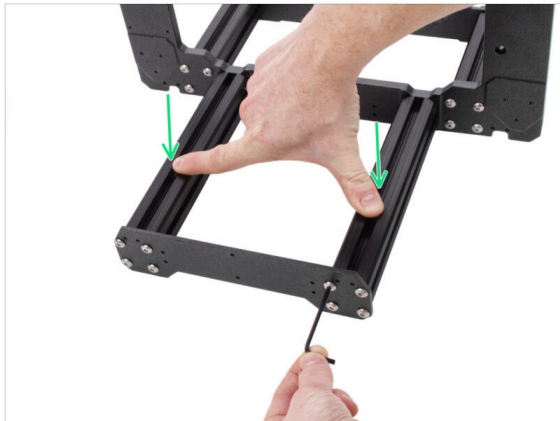

- ⚠ Before you proceed any further, please make sure the frame is standing on a **FLAT SURFACE**.
- The frame screw openings are drilled by a high-precision CNC machine. Uneven tightening during can slightly warp the frame assembly. It can be corrected though.
- Using your hand, try to wiggle the frame side to side to check whether some of the corners are lifting up.
- In case you find any imperfections, release the screws, press the extrusions against the **FLAT SURFACE** and tighten them again. Then check if the frame still rocks side to side, back and forth. **Rotate the whole assembly 90 degrees and check again.** Repeat the whole process if necessary.
- ⚠ If any of the corners isn't lifting more than 2mm (0.08 inch) high, proceed to the next step.

## STEP 12 Mounting antivibration feet and cable clips: parts preparation



● For the following steps, please prepare:

● Antivibration foot (4x)

● Cable clip (6x)

## STEP 13 Mounting antivibration feet



● Turn the whole frame assembly onto the side and insert an antivibration foot into the bottom groove of the each extrusion. Insert and turn 90 degrees to lock it in place.

● Repeat this process for all 4 feet. Place them 1-2 cm far from the end of each extrusion.



### STEP 14 Installing the cable clip

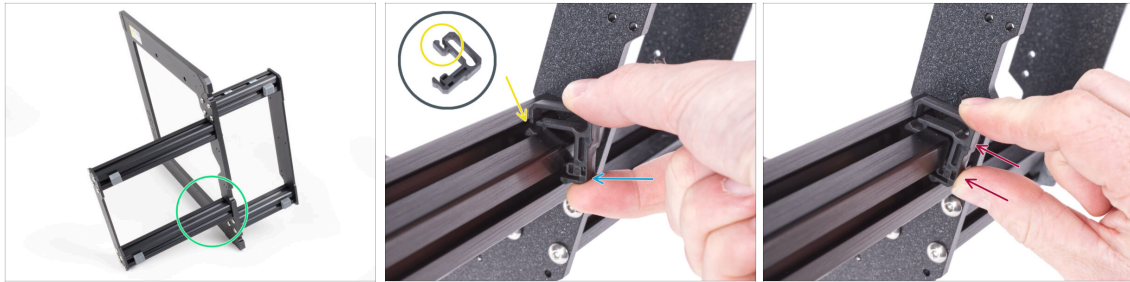

- Turn the frame like in the picture and focus on the marked area
- Take one of the cable clips and hook the side with the clip into the inner groove of the lower longer extrusion. There is a hook on the part, see the detail.
- Place the other end of the clip on the underside of the extrusion.
- Use more force to push on the bottom side of the cable clip. It must fit into the groove and you must feel it "click" in.

### STEP 15 Installing the cable clips



- Install three clips to the long extrusion.
- Install one clip to the short extrusion.
- Turn the frame, install two clips to the second short extrusion.

## STEP 16 PSU: parts preparation



- ◆ For the following steps, please prepare:
- ◆ Delta PSU 240 W 24 V (1x)
- ◆ M3x10 screw (2x)
- ◆ M4x10r screw with dome head (2x)
- ⓘ The PSU (Power Supply Unit) is designed to work worldwide and automatically adapt to the local voltage.

## STEP 17 Attaching the PSU



- ◆ Have a look at the right side of the frame and locate the M3nE nuts. Insert M3x10 screws into them. Turn them only 3-4 times by using a 2.5mm Allen key, just for the screws to be kept in place.
- ◆ Take the PSU and place it above the screws. Adjust the M3nE nuts so they line up with the grooves on the bottom of the PSU's case.
- ◆ Slide the PSU down onto the screws. Screw them in some more, but **don't tighten them firmly yet** - we need the PSU to be able to move slightly so we can adjust its position in the next step!
- ⓘ The screws should be able to hold the PSU in a "vertical" position for now.

## STEP 18 Securing the PSU

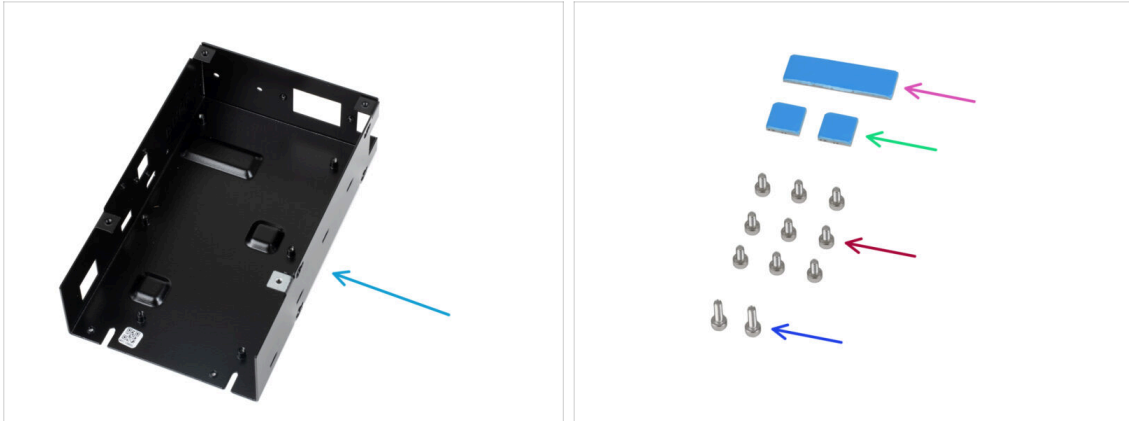

- Now have a look at the frame from the front side. Verify the PSU is on the right back side of the frame when looking from the front.
- Insert M4x10r screws into the holes in the frame, towards the front of the PSU.
- Adjust the position of the PSU, there are holes in the PSU's case, which must align with the holes in the frame. By default the PSU sits slightly lower than needed, pull it up little bit. until the M4 screws are able to catch the thread in the PSU.
- Make sure the PSU is pressed against both the frame and the extrusion on the bottom.
- Everything aligned? Tighten the M4 screws up using the same 2.5mm Allen key.
- Now, tighten up the M3 screws on the bottom.

**STEP 19** xBuddy box: parts preparation

◆ For the following steps, please prepare:

◆ xBuddy box (1x)

ⓘ xBuddy box is located in the box with plastic parts.

◆ Thermal pad 40x12x2.2 mm (1x)

◆ Thermal pad 12x12x2.2 mm (2x)

◆ M3x6 screw (9x)

◆ M3x10 screw (2x)

ⓘ The list continues in the next step...

**STEP 20** Mounting the xBuddy box: parts preparation

◆ For the following steps, please prepare:

◆ xBuddy board (1x)

⚠ **Always touch the sides of the electronics board while manipulating it. Avoid touching the chips, capacitors and other parts of the electronics.**

◆ Zip tie (4x)

◆ X-holder (1x)

## STEP 21 Mounting the xBuddy box: inserting screws



- Insert four M3x6 screws to the back of the frame (side with shorter extrusions), so they resemble a rectangular pattern. Tighten the screws fully into the frame to clean the threads. Then loosen the screws, **leaving a gap of at least 3 mm between the screw head and the frame.**
  - ⚠ **Make sure you are using the correct holes.**
- Insert two M3x10 screws into the M3nE nuts in the second short extrusion. Turn them only 3-4 times by using a 2.5mm Allen key, just for the screws to be kept in place.

## STEP 22 Attaching the xBuddy box

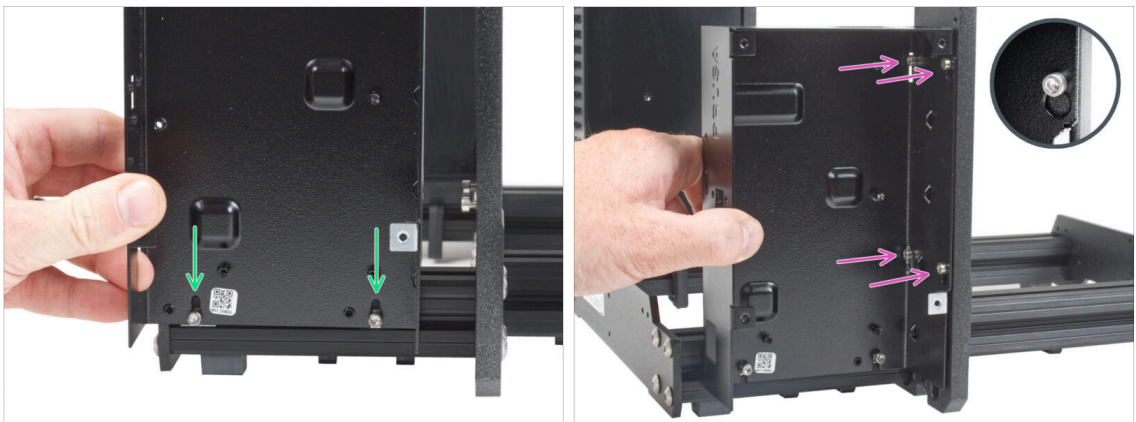

- Attach the xBuddy box on the M3x10 screws in the extrusion. **Do not tighten the screws at the moment!**
- Slide the xBuddy box to the frame and attach the box to all 4 screws in the frame. The screws must fit into the top part of the "key" hole. See the detail.

## STEP 23 Securing the xBuddy box

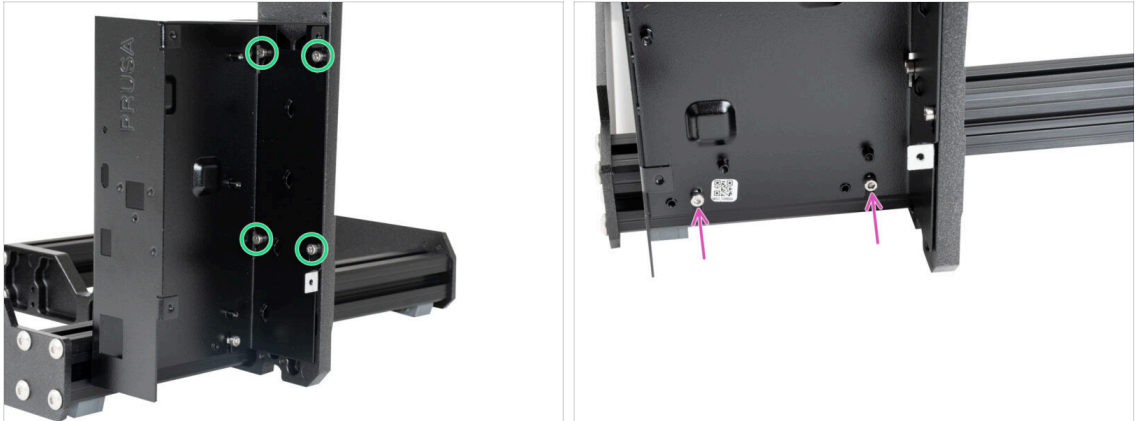

- Fully tighten all four M3x6 screws to secure the xBuddy box.
- ⓘ Be careful when tightening the "rear" top screw. Use the shorter side of the Allen key for final tightening.
- Fully tighten both M3x10 screws in the M3nE nuts.

## STEP 24 Applying the thermal pads

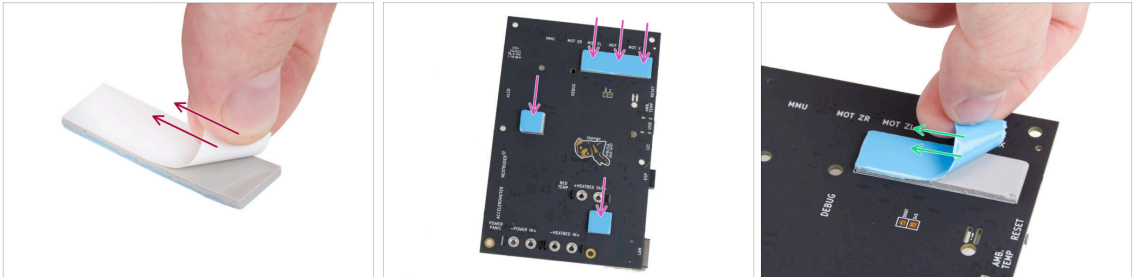

- Peel off the white protective layer from all thermal pads.
- ⚠ **Always touch the sides of the electronics board while manipulating it. Avoid touching the chips, capacitors and other parts of the electronics.**
- Attach the pads onto the back of the xBuddy board. There are markings that indicate the correct size and positions.
- ⓘ The surface to which the pads are stucked must be cleaned of grease. This will ensure better adhesion.
- ⚠ **For the protection of the board's electronic components, we strongly recommend placing the xBuddy board on the soft pad. You can use the original xBuddy bubble wrap package.**
- Peel off the blue protective layer from all thermal pads.

## STEP 25 Mounting the xBuddy board

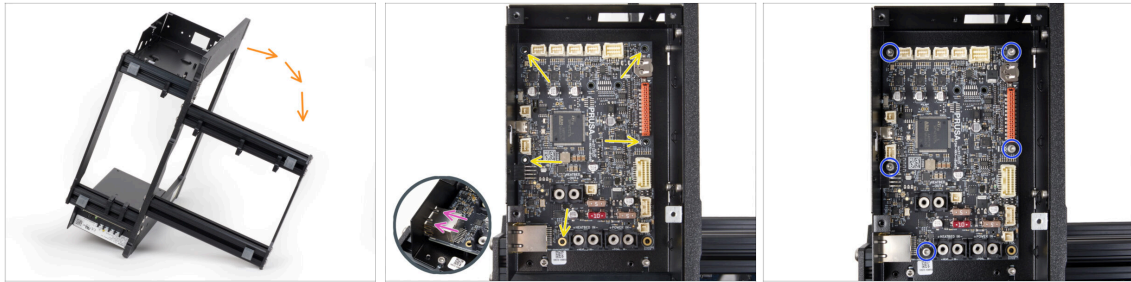

- For better access to the xBuddy box, carefully place the frame on the side with the PSU.
- Insert the xBuddy board into the xBuddy box. **Before fully attaching it completely, center the holes** in the board with the holes (columns) in the xBuddy box
- Make sure the Ethernet connector is properly inserted into the hole in the xBuddy box.
- Fix the position of the xBuddy board by inserting **five M3x6 screws**. **Do not fully tighten the screws**. A few turns are enough for now.
  - ⚠ **Put aside your instinct and leave the hole on the bottom right empty.**
- Fully tighten all five screws. **But very carefully**, otherwise you can damage the electronics board.

## STEP 26 Attaching the zip ties

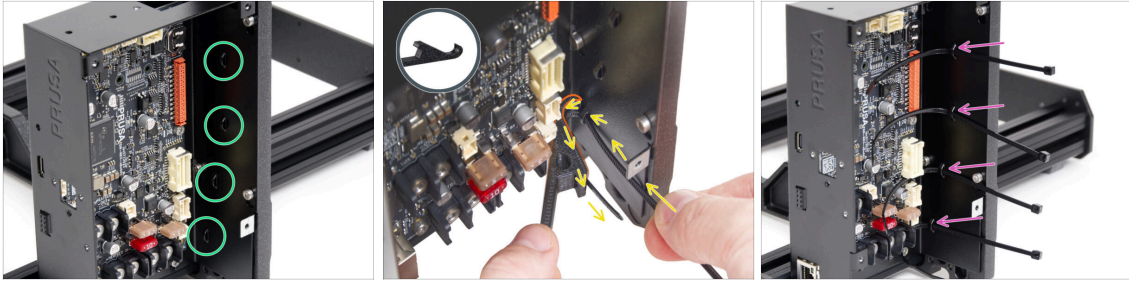

- ◆ Take a closer look at to the xBuddy box. There are four perforations on the metal case.
- ⓘ You can place the frame on the PSU side for better access to the xBuddy box.
- ⚠ **Proceed very carefully. Be careful not to damage the connectors or capacitors on the xBuddy board.**
- ◆ Use the X-holder as a zip tie guidance. Place the X-holder behind the lowest perforation like in the picture. Push the zip tie through the protrusion to the X-holder. Keep protruding 3 - 5 cm of the zip tie from the perforation.
  - ⚠ **Note the correct orientation of the zip tie. The teeth on the zip tie must be on the visible side.**
- ◆ Use this procedure for all four protrusions.
- ⚠ **Do not discard the X-holder. You will need it later again.**
- ◆ Place the printer back on its "feet".

## STEP 27 Y-belt-idler: parts preparation

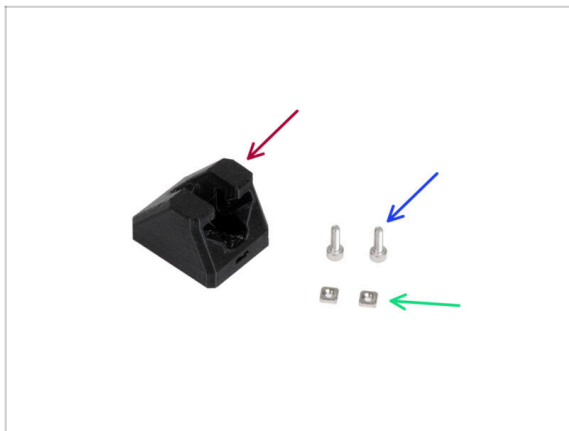

- ◆ **For the following steps, please prepare:**
- ◆ Y-belt-idler (1x)
- ◆ M3x10 screw (2x)
- ◆ M3nS nut (2x)



## STEP 28 Assembling Y-belt-idler



- ◆ Insert two M3nS nuts into the Y-belt-idler.
  - ⓘ There is a groove in the hole for pushing the nut all the way in with an Allen key.

## STEP 29 Mounting the Y-belt-idler

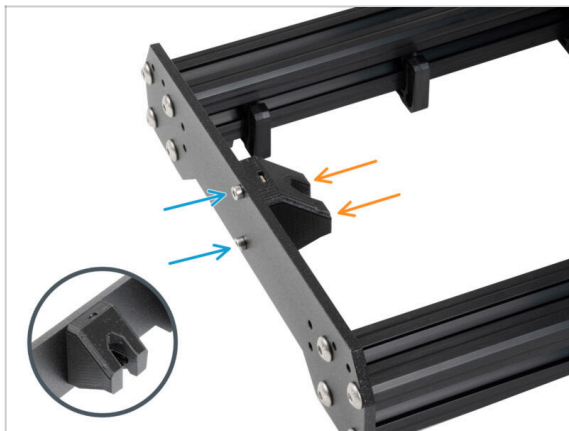

- ◆ Arrange the frame so that the longer extrusions are facing you.
- ◆ Attach the Y-belt-idler from "inside" to the front plate. **Note the correct orientation of the part.**
- ◆ Secure the Y-belt-idler with two M3x10 screws.

## STEP 30 Assembling the Y motor: parts preparation

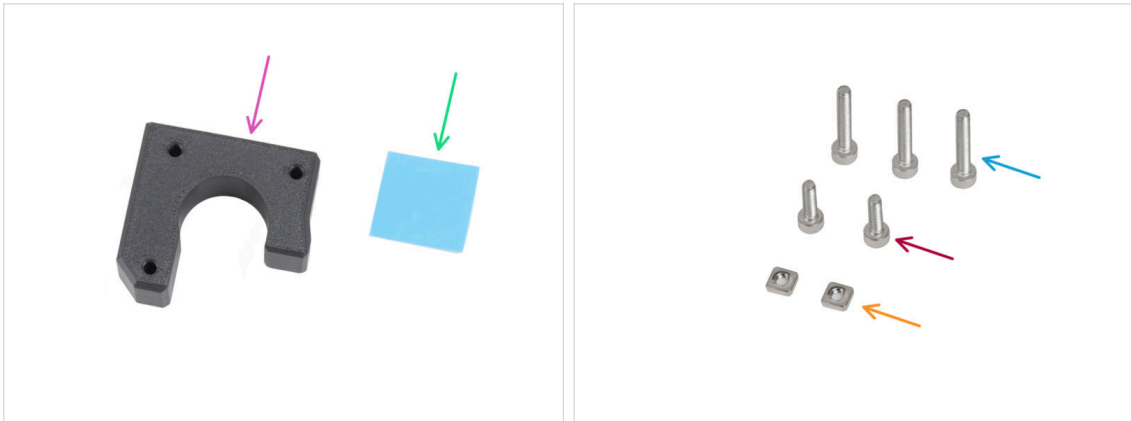

● For the following steps, please prepare:

- Y-motor-holder (1x)
- Thermal pad 25 x 25 x 1.2 mm (1x)
- M3x18 screw (3x)
- M3x10 screw (2x)
- M3nS nut (2x)

ⓘ The list continues in the next step...

## STEP 31 Assembling the Y motor

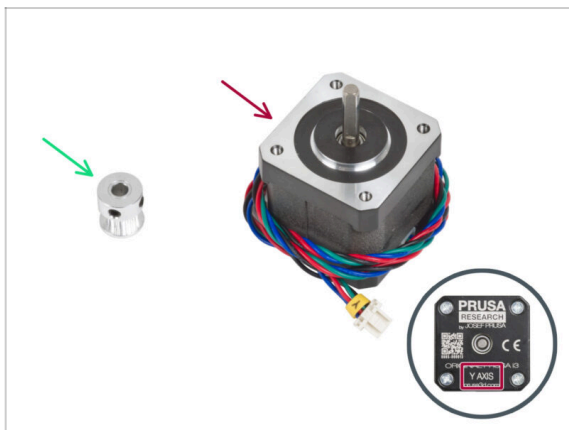

● For the following steps, please prepare:

- Y motor (1x)

⚠ **Ensure you are using the correct motor**, there is a label on the bottom of the casing. The reason is, each motor has different cable length.

- GT2-16 pulley (1x)

## STEP 32 Assembling the Y-motor-holder



- ◆ Insert the M3nS nut into the corresponding openings on the top side of the Y-motor-holder. Using the Allen key, push the nut all the way in.
  - i Some older versions of the part may be slightly different visually. However, this does not affect the procedure.
- ◆ Insert the M3nS nut all the way into the part from the side.
- ◆ Place the Y motor like in the picture. Use the motor cable as a guide.
- ◆ Attach the Y-motor-holder onto the Y motor and join both parts together with three M3x18 screws.

## STEP 33 Adjusting the Y-motor pulley



- ◆ There is a flat part on the motor shaft. Rotate the shaft, so the flat part is facing you through the opening in the Y-motor-holder.
- ◆ Attach the pulley on the shaft and ensure that one of the grub screws is facing the flat part of the shaft. **Do not tighten the grub screw yet.**
  - ⚠ **Note the CORRECT ORIENTATION of the pulley.**
- ◆ Put one of the Allen keys on the **MOST TOP surface** of the printed part, like in the picture. And align the pulley with the Allen key.
- ◆ When the pulley is aligned, tighten the grub screw in the pulley against the flat part of the **shaft**. **Then rotate the pulley and tighten the second grub screw.**

## STEP 34 Attaching the Y-motor-holder

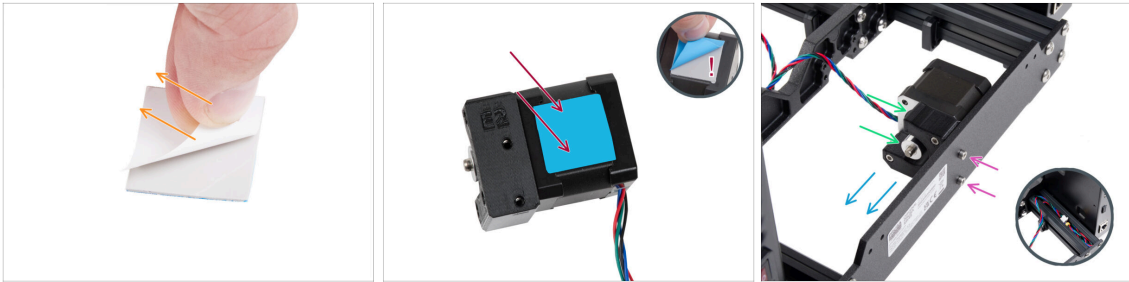

- Peel off the white protective film from the thermal pad 25x25x1.2 mm.
  - ⓘ The side with the white film is more adhesive. If you have a thermal pad with a blue protective film on both sides, the side doesn't matter.
- Stick the thermal pad on the Y motor and **peel off the second protective layer** from it.
  - ⓘ The surface to which the pad is stuck must be cleaned of grease. This will ensure better adhesion.
- Place the Y-motor-holder onto the inner side of the rear plate of the frame.
- Ensure the correct orientation. The pulley must be facing towards the PSU.
- Attach the Y-motor-holder by using two M3x10 screws.
- To keep the Y motor cable safe during the assembly, temporarily hide it in the extrusion on the xBuddy box side.

## STEP 35 Haribo

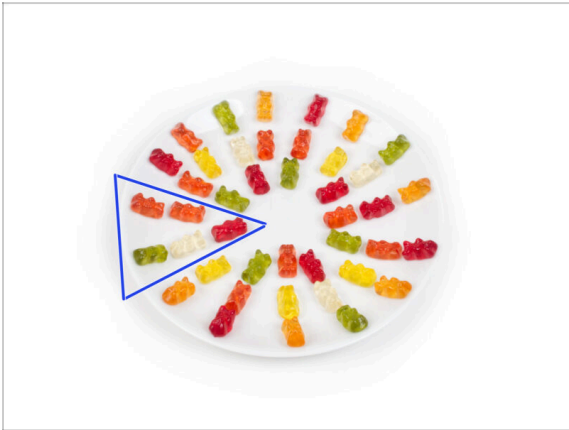

**⚠ Carefully and quietly open the bag with the Haribo sweets. High level of noise might attract nearby predators!**

- ◆ Spread the entire contents of the bag on a clean plate and arrange them according to the picture. The color doesn't matter that much.
- ⓘ The total number in your package may vary slightly. However, the exact number is important. If any gummy bears are missing, please go to your nearest candy store immediately.
- ◆ Eat five gummy bears.
- ⓘ **Did you know that** gummy bears were first created by a German candy maker named Hans Riegel in the 1920s.

## STEP 36 It's done!



- ◆ Compare the final look of the assembly with the picture.
- ◆ So that was an easy start, wasn't it? Good job anyway!
- ◆ Now, let's play with the next chapter: **3. X-axis & X-carriage assembly**

### 3. X-axis & X-carriage assembly



## STEP 1 Tools necessary for this chapter

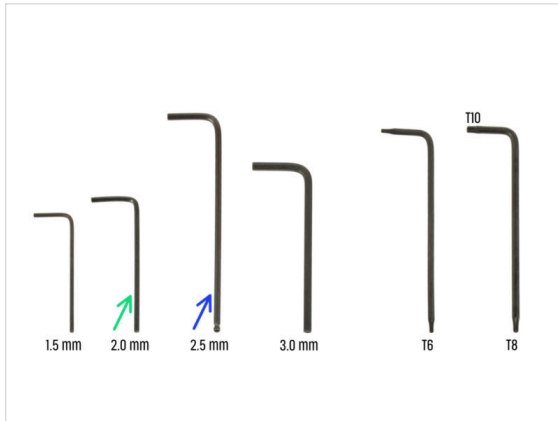

● For this chapter, please prepare:

- 2.0mm Allen key
- 2.5mm Allen key
- Permanent marker (*not included in the kit*)

## STEP 2 X-axis assembly: parts preparation

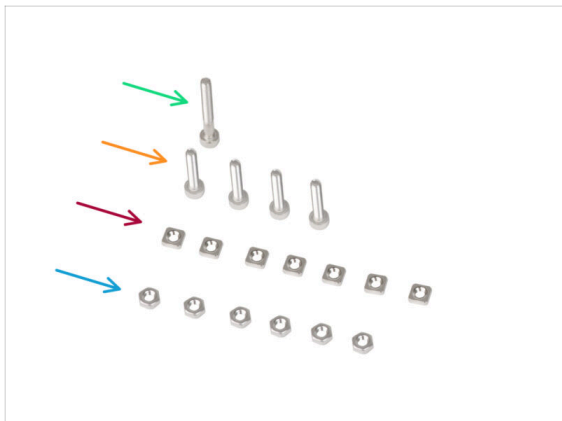
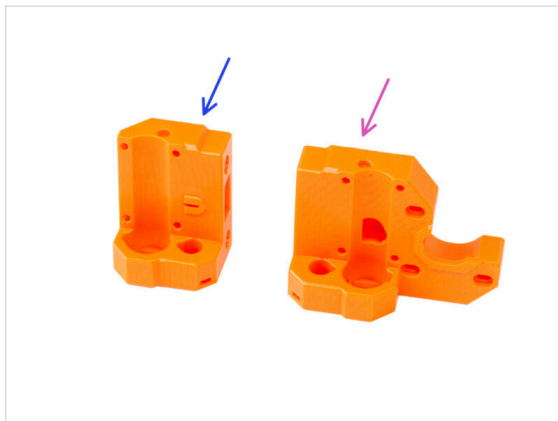

● For the following steps, please prepare:

- X-end-idler (1x)
- X-end-motor (1x)
- M3x25 screw (1x)
- M3x16 screw (4x)
- M3nS nut (7x)
- M3n nut (6x)

### STEP 3 Assembling the X-end-motor (part I)



- ◆ Insert four M3n nuts into the holes on the backside of the X-end-motor.
  - i Use the screw pulling technique.
- ◆ Insert and tighten the M3nS nut into the plastic part.
- ◆ Screw the M3x25 screw into the plastic part. Do not tighten the screw completely. Keep the screw head aligned with the top surface of the part.
- ◆ From the "bottom" side of the part, insert and tighten the M3x16 screw.
  - ⚡ There is no thread in the plastic part, no nut. The screw cuts a thread into the plastic when tightened.
- ⚠ **Make sure you are using the correct length of the screw M3x16, not M3x18. If you're not sure, always compare the dimensions of the screws with the cheatsheet.**
- ◆ Insert and tighten one M3x16 screw from the "top" side of the part.

### STEP 4 Assembling the X-end-motor (part II)

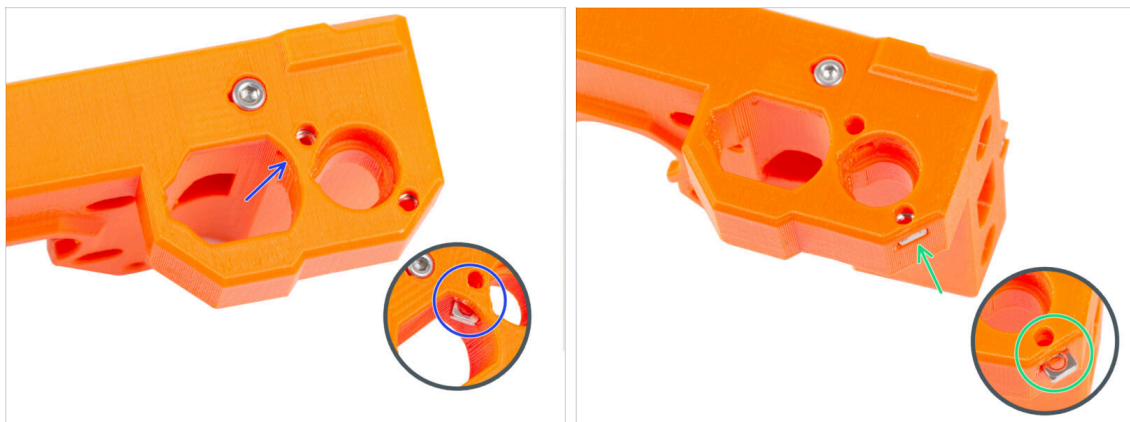

- ◆ From inside the oval opening, insert the M3nS nut into the X-end-motor.
- ◆ From the side, insert the second M3nS nut into the part.
- ⚠ **Do not put too much pressure on the nut to avoid damaging the opposite printed wall.**



## STEP 5 Assembling the X-end-idler (part I)

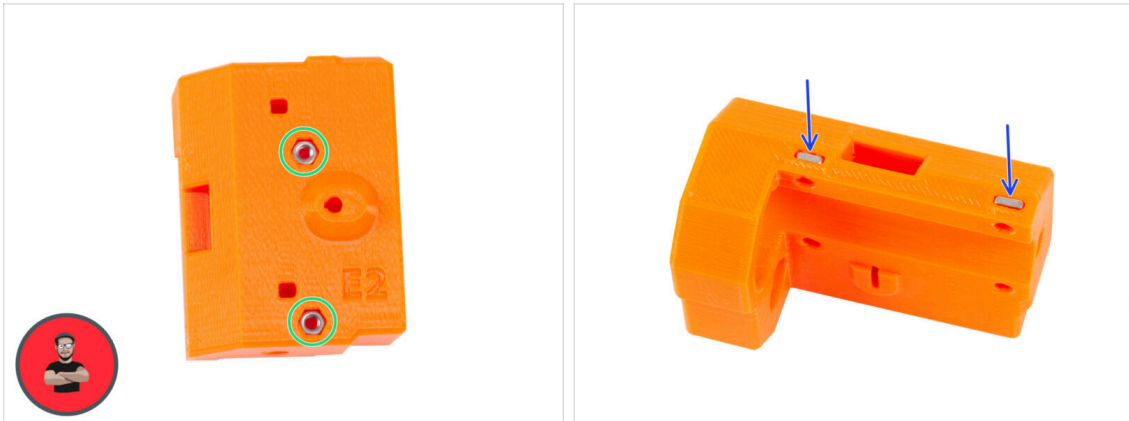

- Insert two M3n nuts into the holes on the backside of the X-end-idler.
  - Use the screw pulling technique.
- Insert two M3nS nut from the side to the plastic part.

## STEP 6 Assembling the X-end-idler (part II)

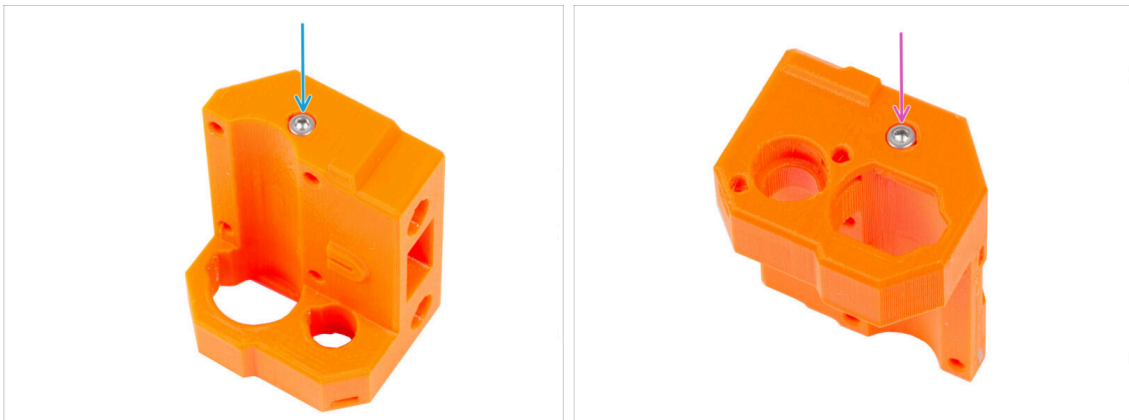

- Warning:** Make sure you are using the correct length of the screw **M3x16**, not M3x18. If you're not sure, always compare the dimensions of the screws with the cheatsheet.
- From the "bottom" side of the part, insert and tighten the M3x16 screw.
  - There is no thread in the plastic part, no nut. The screw cuts a thread into the plastic when tightened.
- Insert and tighten the second M3x16 screw from the "top" side of the part.

## STEP 7 Assembling the X-end-idler (part III)

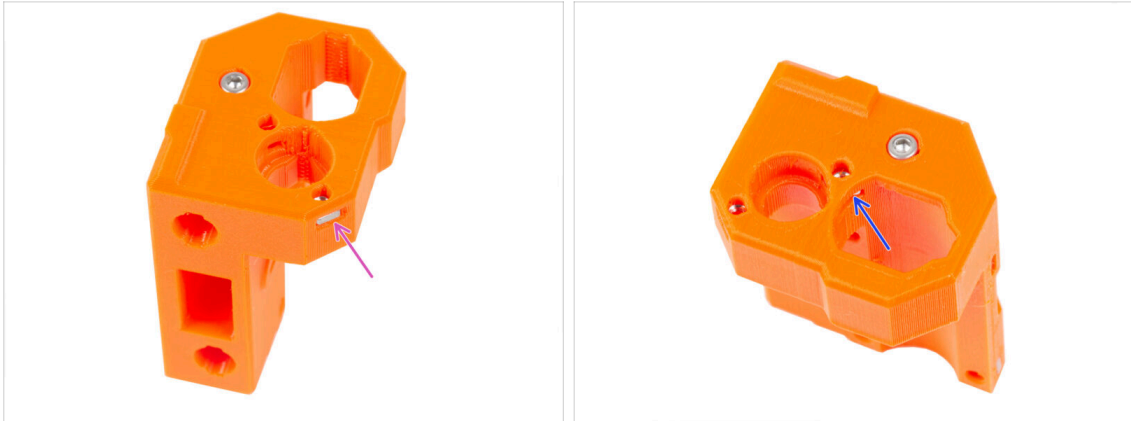

🟪 Insert the M3nS nut into the X-end-idler from the side.

⚠️ Do not put too much pressure on the nut to avoid damaging the opposite printed wall.

🟦 From inside the oval opening, insert the M3nS nut into the X-end-idler.

## STEP 8 Mounting the bearings: parts preparation

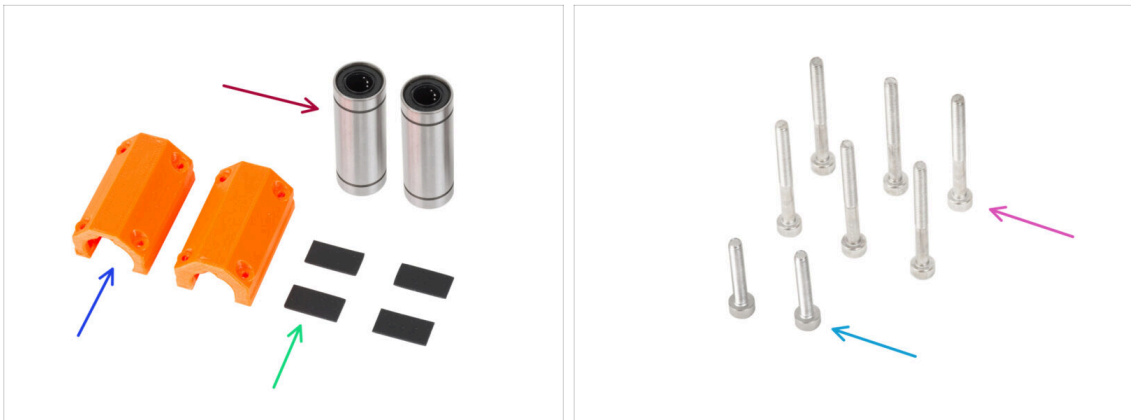

⬛ For the following steps, please prepare:

🟪 LM10LUU linear bearing (2x)

⬛ The bearings come pre-lubricated from our factory and do not require additional lubrication upon initial use.

🟦 X-end-clip (2x)

🟩 Rubber pad 20x10x1 mm (4x)

🟪 M3x30 screw (6x)

🟦 M3x18 screw (2x)

## STEP 9 Inserting the bearings: bearing pads



- ◆ Take one X-end-clip. Notice, there are two rectangular pockets inside the plastic part.
- ◆ Place the rubber pads into both pockets by pushing the finger on them.
- ◆ Apply the same procedure for both X-end-clips.

## STEP 10 Inserting the bearings: bearing clips



- ◆ Carefully insert one of the LM10LUU bearings into the bearing clip.
- ◆ Push it as far as possible to the rear edge of the bearing clip.
- ⚠ **Make sure the bearing pads are in place when inserting the bearing.**
- ◆ Position the bearing like in the third picture. The ball rows must be oriented to "X" in the bearing clip.
- ◆ Repeat the same procedure for the second bearing clip.

## STEP 11 Covering the bearings: X-end-motor



- ◆ Insert the bearing clip assembly into the bearing guide channel in the X-end-motor.
- ◆ Slide the bearing clip assembly with the bearing as close as possible to the stop lug of the X-end-motor.
- ◆ Insert four M3x30 screws into the X-end-clip. Tighten the screws diagonally.
- ◆ Tighten the screws completely, **but diagonally**.

## STEP 12 Inserting the bearings: X-end-idler



- ◆ Insert the bearing clip assembly into the bearing guide channel in the X-end-idler.
- ◆ Slide the bearing clip assembly with the bearing as close as possible to the stop lug of the X-end-idler.
- ◆ **There are two types of the screws for the X-end-clip on the X-end-idler:**
  - ◆ Insert two M3x30 screw into the holes on the **left side**.
  - ◆ Insert two M3x18 screws into the holes on the **right side**.
- ◆ Tighten the screws completely, **but diagonally**.

## STEP 13 Assembling the X-axis: parts preparation



● For the following steps, please prepare:

⚠ Notice that you have received **three different lengths of smooth rods**. We recommend arranging them all side by side, for easier comparison of their sizes.

● Smooth rod 8x370 mm (2x) *the longest couple*

ⓘ Wipe off the preservative oil from the smooth rods with a paper towel or a piece of cloth.

● LM8UU bearing (3x)

● The bearings come pre-lubricated from our factory and do not require additional lubrication upon initial use.

## STEP 14 Assembling the X-axis: Marking the bearings

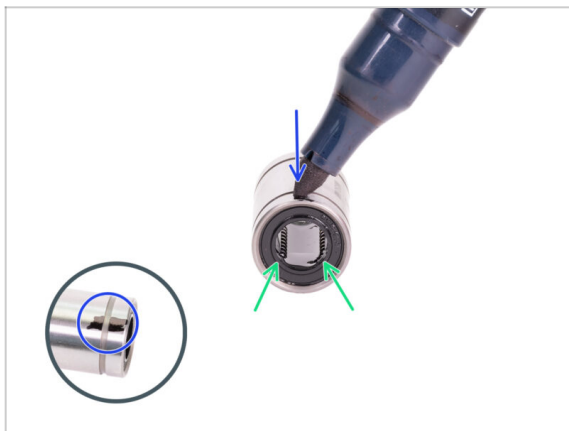

● Wipe grease from the outer surface of the bearing with a paper towel.

● Position the bearing so that you can see two rows of balls. Like in the picture.

● Make a mark with a permanent marker on the outer surface of the bearing, in the middle above two rows of balls.

● Use the same procedure for the remaining two bearings.

ⓘ We will use these markings in the upcoming chapters to achieve the desired bearing orientation.

## STEP 15 Assembling the X-axis: Inserting smooth rods



✿ Insert the smooth rods all the way into the X-end-idler.

⚠ **Insert the rods very carefully. Do not tilt the rods too much.**

🔵 Through the inspection hole check if the smooth rods are in touch with the screws inside the part.

🟠 **Carefully and gently** slide three bearings onto the smooth rods. One bearing on the upper rod and two bearings on the lower rod. See the picture. Orientation of the markings doesn't matter at this moment

📄 In case you manage to push out balls from the bearings, please count them. One or two balls are ok, if there are more of them, please consider ordering new bearings.

## STEP 16 Assembling the X-axis: mounting the X-end-motor

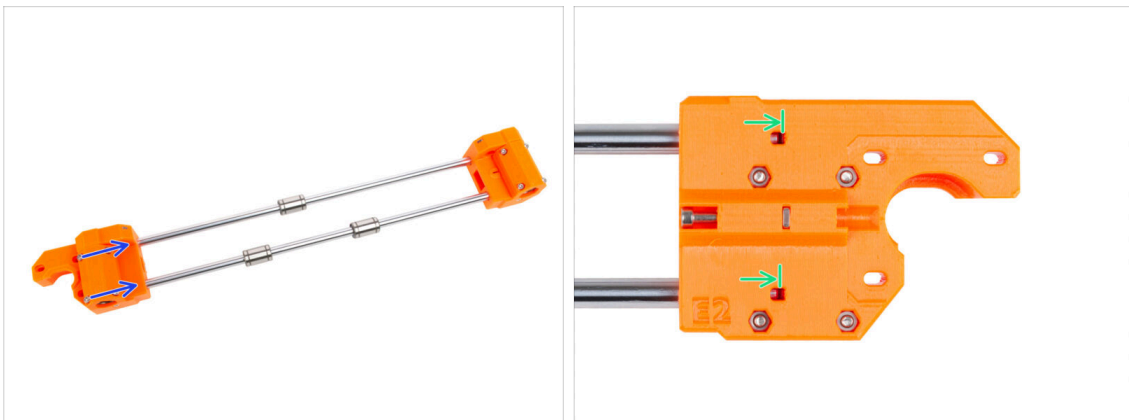

🔵 Carefully slide the X-end-motor fully onto both smooth rods.

🟢 Through the inspection hole check if the smooth rods are in touch with the screw.

## STEP 17 Assembling the X-carriage: parts preparation



● For the following steps, please prepare:

- X-carriage (1x)
- Hex spacer M3x10 (3x)
- M3n nuts (2x)
- M3x10 screw (3x)
- M3nS nut (8x)

## STEP 18 Assembling the X-carriage

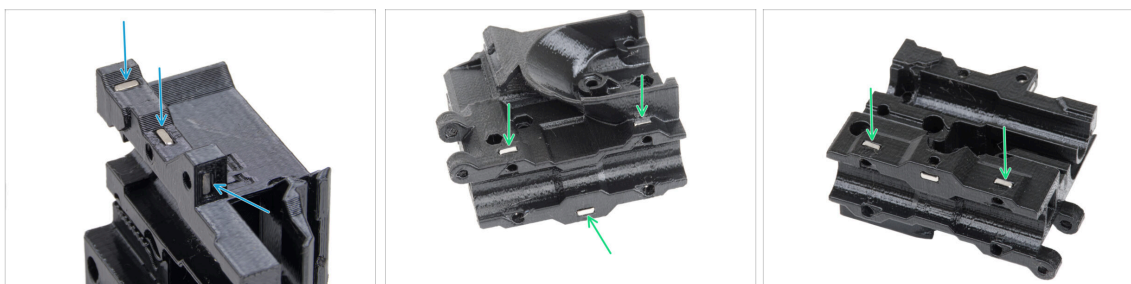

- Locate the protrusions on the X-carriage part and insert three M3nS nuts into the square holes.
- From the "bottom" of the part, insert five M3nS nuts into the part.

## STEP 19 Attaching the spacers



- Insert two M3n nuts to the X-carriage-back.
- ⓘ Use the screw pulling technique.
- From the opposite side, insert the M3x10 screw into the X-carriage-back. The screw must protrude from the "front" side of the part.
- Attach the hex spacer on the M3x10 screw and tighten the screw. **Note the cutout of the same shape as the spacer. It must fit perfectly and must not rotate.**

## STEP 20 Securing the spacers



- Push two M3x10 screws through the X-carriage
- From the "front" side of the X-carriage, attach two hex spacers on the protruding M3x10 screws in the same way described in the previous step. Tighten the screws.
- ⚠ **Note the cutout of the same shape as the spacer. It must fit perfectly and must not rotate.**



## STEP 21 Assembling the X-carriage-clip: parts preparation

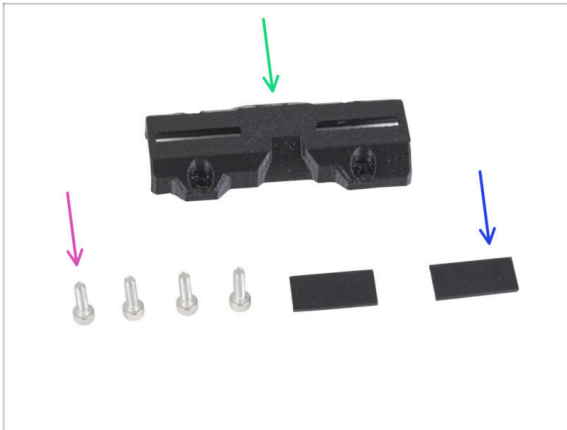

◆ For the following steps, please prepare:

- ◆ X-carriage-clip (1x)
- ◆ M3x10 screw (4x)
- ◆ Rubber pad 20x10x1 mm (2x)

## STEP 22 Assembling the X-carriage-clip



- ◆ Place two rubber pads into the rectangular pockets inside the X-carriage-clip.

## STEP 23 Attaching the X-carriage-clip

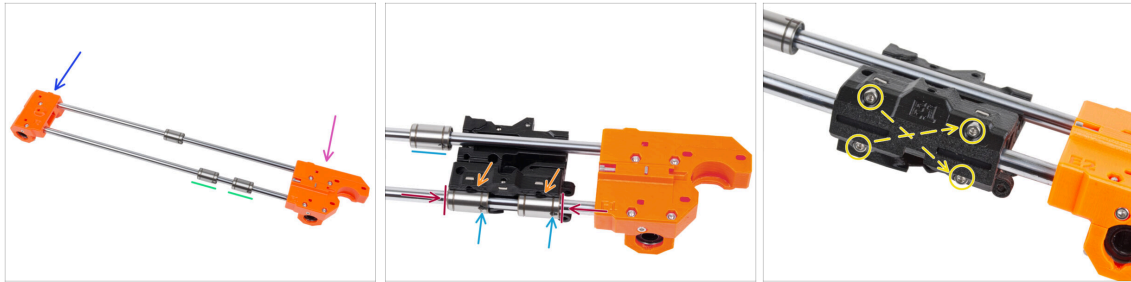

**⚠ CAUTION: Make sure you have the parts oriented correctly:**

- ◆ X-end-idler on the left.
- ◆ X-end-motor on the right.
- ◆ Two bearings on the "lower" smooth rod (closer to you).
- ◆ Attach the X-carriage on both bearings on the lower rod. See the orientation of the X-carriage-motor on the picture.
- ◆ Slide both lower bearings all the way into the pockets in the X-carriage and align them with the outer surface of the X-carriage.
- ◆ Rotate both bearings so that the marking is facing you (down). Leave the upper bearing out of the X-carriage for now.
- ◆ Cover the bearings with the X-carriage-clip and secure it by four M3x10 screws. Notice the orientation of the part. **Do not fully tighten the screws at the moment.**

## STEP 24 Attaching the X motor: parts preparation

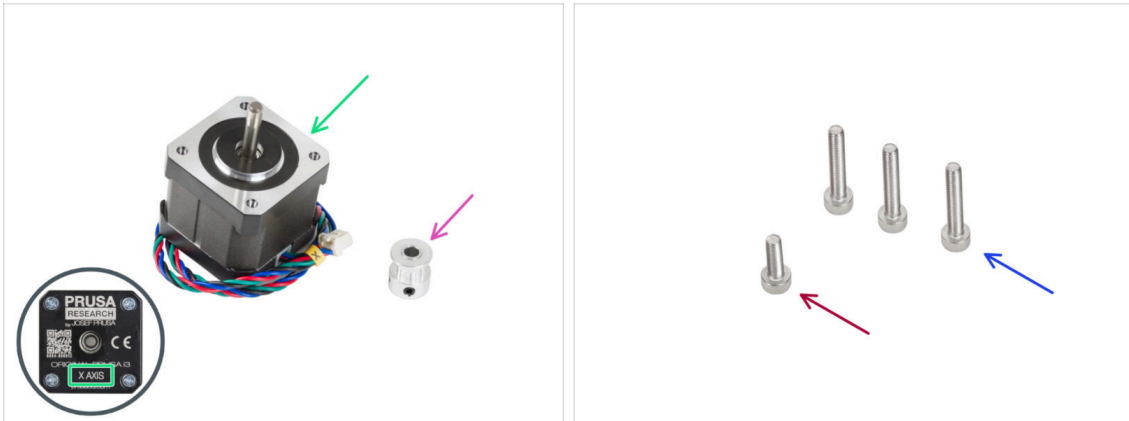

For the following steps, please prepare:

X motor (1x)

⚠ **Ensure you are using the correct motor, there is a label on the bottom of the casing. The reason is, each motor has different cable length.**

GT2-16 pulley (1x)

M3x18 screw (3x)

M3x10 screw (1x)

## STEP 25 Attaching the X motor

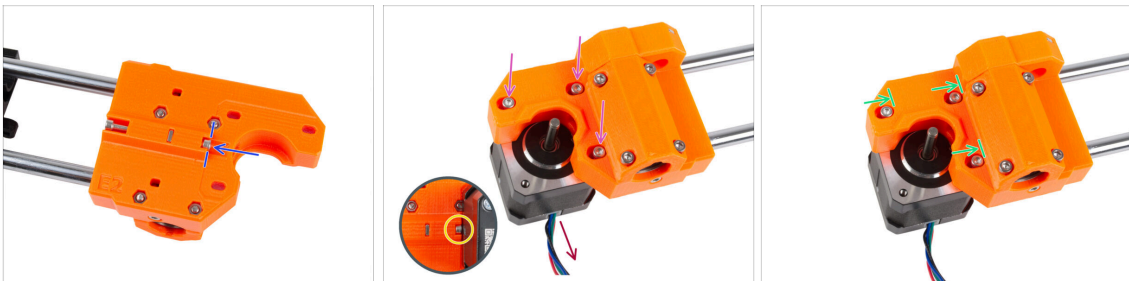

Insert the M3x10 screw into the X-end-motor. Line up it with the edge of the plastic protrusion. Do not tighten the screw, there is no thread inside, just insert it freely.

Place the X-end-motor on the X motor. Secure it by three M3x18 screws. **Tighten the screws just slightly.** We will adjust them later on.

⚠ **Note the correct X motor orientation. The cable must be facing you.**

Make sure that the "tension" screw on the X motor side does not fall out during handling.

Position the motor so that the screws are at the inner end of the oval holes.

## STEP 26 Attaching the X motor: mounting the pulley

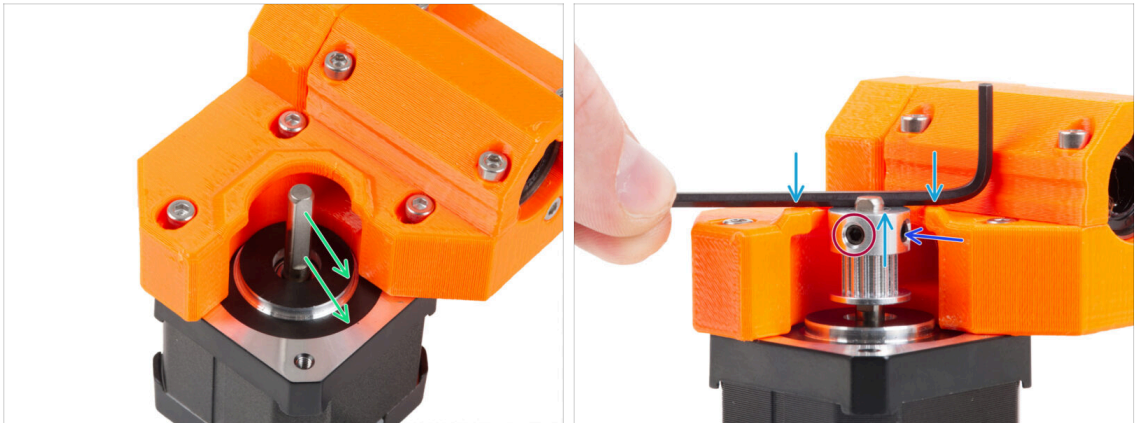

- ◆ There is a flat part on the motor shaft. Rotate the motor shaft with the flat part facing through the opening in the X-end-motor.
- ⚠ Slide the Pulley on, note the **CORRECT** orientation. Compare it with the second picture!
- ◆ Place any of the Allen keys on the top surface, like in the picture and align the pulley with the Allen key.
- ◆ **One of the grub screws must be facing directly against the flat part of the shaft.** Tighten the grub screw.
- ◆ Rotate the pulley and tighten the second grub screw.

## STEP 27 Guiding the X belt: parts preparation

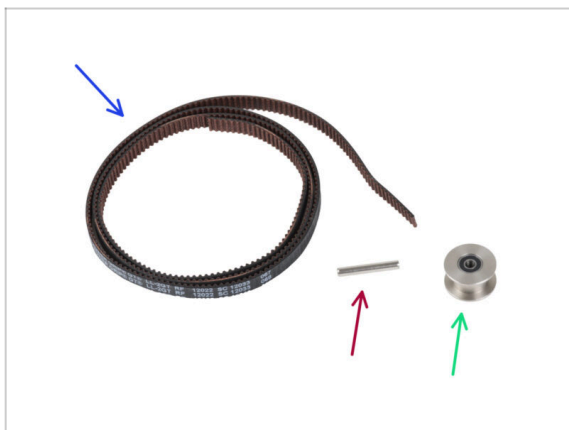

- ◆ **For the following steps, please prepare:**
- ◆ X belt (1x)
- ◆ Pin H8 2.9x20 (1x)
- ◆ GT2-20 Idler pulley (1x)

## STEP 28 Guiding the X belt: X-end-idler



- 🟠 Guide the X belt around the Idler pulley.
- 🟡 Insert the "clamped" pulley with the belt inside the X-end-idler.
- 🟢 Align the hole in the pulley with the left hole in the plastic part.
- 🟣 After aligning the pulley, push the pin through the plastic part and the pulley. Push the pin all the way in using the Allen key.
- ⚠️ **Do not apply excessive force** when pushing the pin, as this could cause the pin to push through the plastic part, resulting in its breakage.
- 🟡 Pull lightly on the belt to secure the position of the pulley. You will see the pin in the hole slide inside the part. Once the pulley is secured, the pin is not visible at all.

## STEP 29 Guiding the X belt: X-end-motor

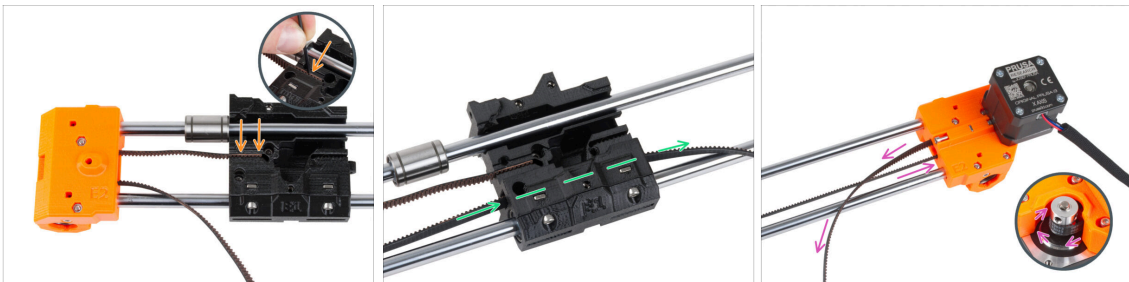

- 📄 Leave the upper bearing free for now.
- 🟠 Insert the "upper" end of the belt into the groove in the X-carriage. Push it all the way in using the Allen key.
- 🟢 Push the "lower" end of the belt through the belt channel in the X-carriage.
- 🟣 Guide the belt through the X-end-motor around the pulley and back to the X-carriage.

### STEP 30 Guiding the X belt: X-carriage

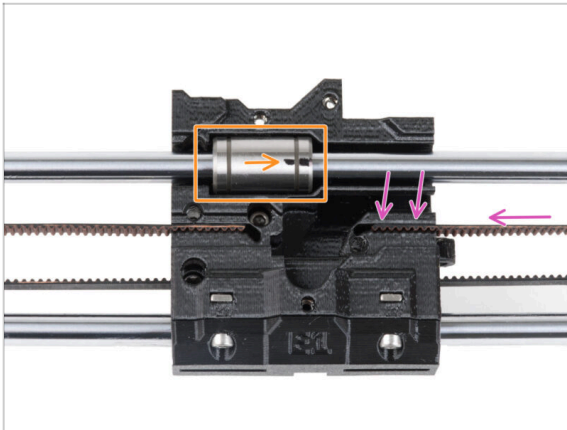

- ◆ Guide the X belt to the X-carriage and push it to the groove in the plastic part as far as possible. Push it all the way in using the Allen key.
- ⓘ The belt must not be too loose (sagging). We will adjust its tension later.
- ◆ Place the upper bearing into the recess in the X-carriage. The marking must be facing you, like in the picture.

### STEP 31 Assembling the X-carriage: final check

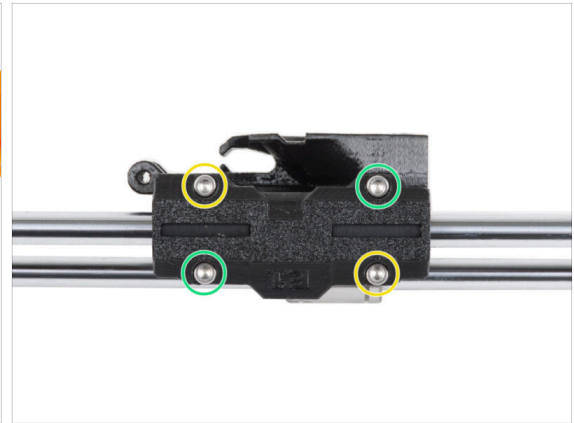
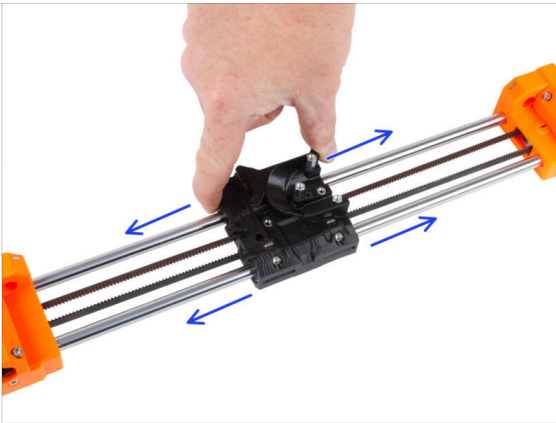

- ◆ Move with the X-carriage side to side several times to check that the movement is smooth.
- ◆ After you ensure that the movement is smooth, fully tighten the screws on the X-carriage-clip in this order:
  - ◆ Upper left screw
  - ◆ Lower right screw
  - ◆ Upper right screw
  - ◆ Lower left screw
- ◆ Move the X-carriage several times to both sides and check the movement is still smooth.

## STEP 32 Haribo



◆ Eat five gummy bears.

ⓘ **Did you know that** the original gummy bears were inspired by the dancing bears of Europe, and Riegel named them "Gummibärchen," which means "little rubber bears" in German.

## STEP 33 It's done!

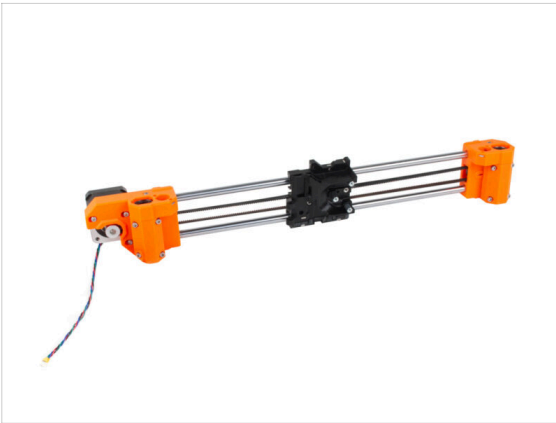

- ◆ Compare your assembly with the picture.
- ◆ Everything is OK? **Nice job**, you just successfully assembled the X-axis assembly.
- ◆ Let's go the next chapter: **4. Z-axis assembly**

## 4. Z-axis assembly

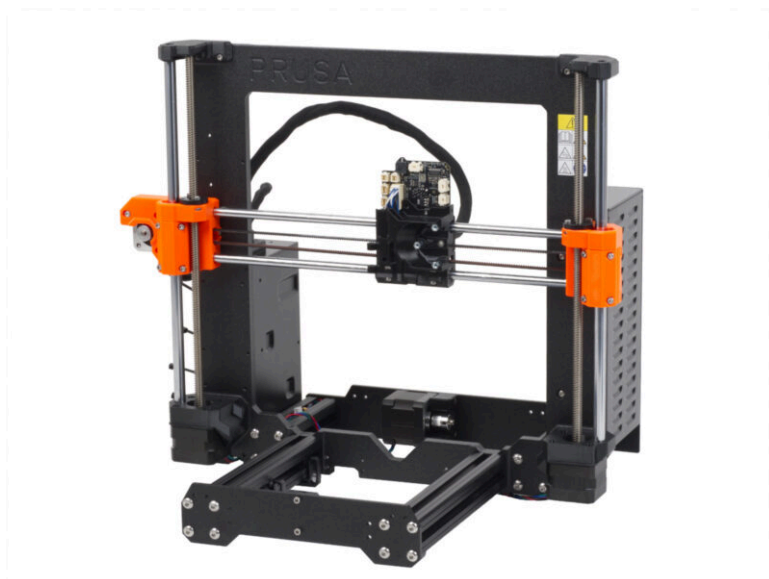



## STEP 1 Tools necessary for this chapter

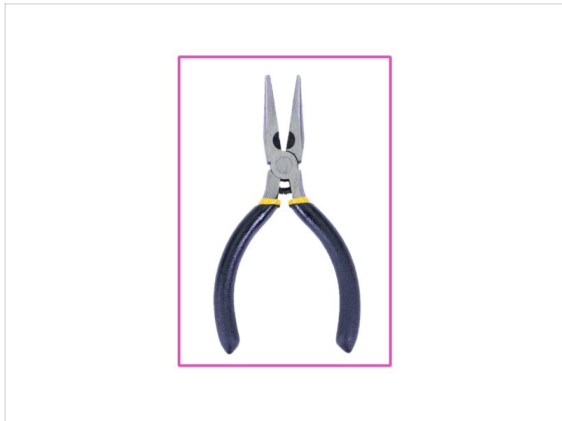
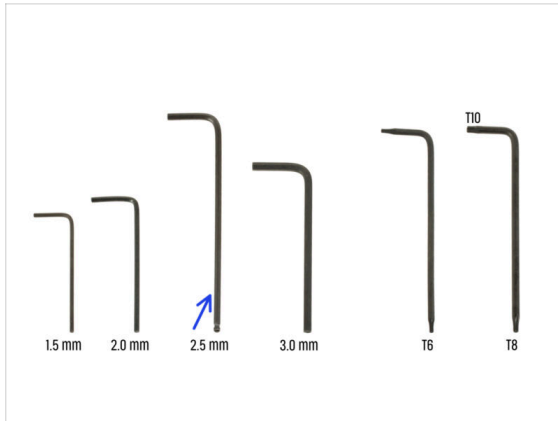

● For this chapter, please prepare:

- 2.5mm Allen key
- Needle-nose pliers

## STEP 2 Assembling the Z-bottoms: parts preparation

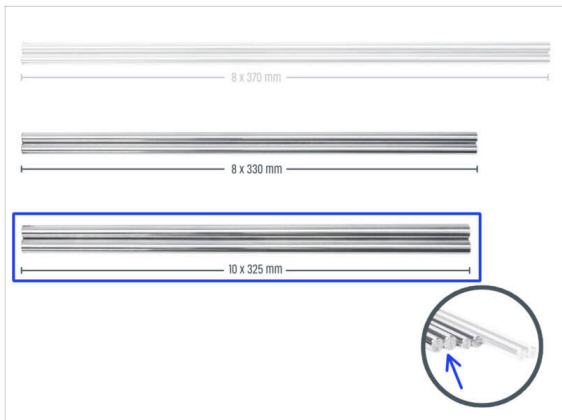
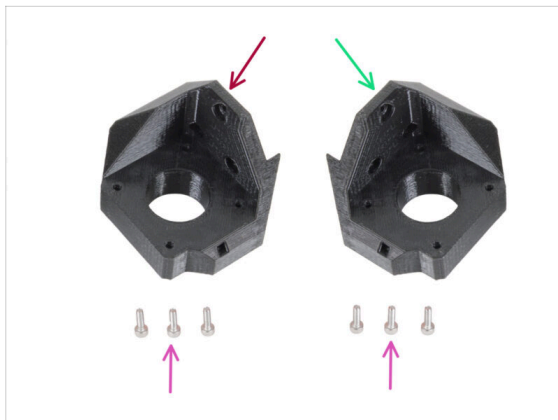

● For the following steps, please prepare:

- Z-bottom left (1x)
- Z-bottom right (1x)
- M3x10 screw (6x)
- Smooth rod 10 x 325 mm (2x)

### STEP 3 Inserting the rods



- ◆ Using a paper towel, clean the smoothing rods of the preservative oil. The smooth rods must be perfectly smooth.
- ◆ Insert each 10mm smooth rod into the Z-bottom. Place in a screw-like motion for easier insertion of the rod.
- ⓘ Tip: If the movement is still stiff, apply a small amount of Prusa lubricant, which is included in your package, to the end of the rod.
- ⚠ Through the inspection hole in both Z-bottoms, check if the rod is completely inserted. **There must be NO gap between the smooth rod and the bottom of the hole.**

### STEP 4 Assembling the Z-bottoms

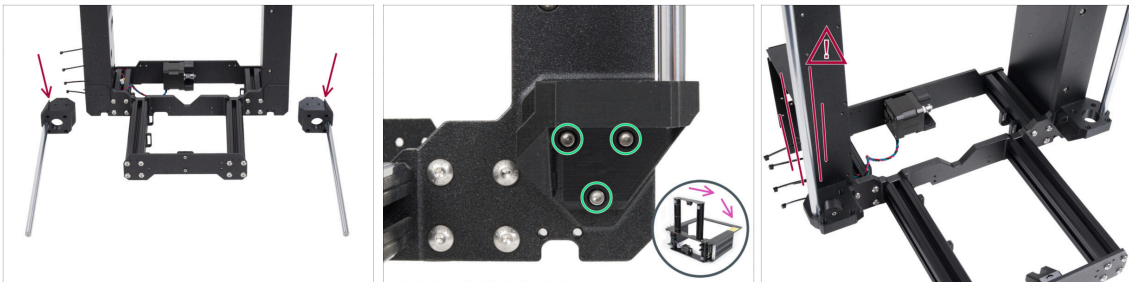

- ⚠ **WARNING:** Printed parts aren't the same! There are left and right pieces. See the protrusion (tooth) on each part. For the right side of the frame, there is a protrusion on the right side of the plastic part and vice versa.
- ◆ Attach both Z-bottoms to the frame and secure each part with three M3x10 screws.
  - ◆ Tip: you can turn the printer on its back side for better access to the Z-bottom installation. It is recommended to place a cardboard pad under the printer to protect your workbench and the printer against scratches.
- ⓘ In case of increased resistance during tightening, try to run the screws through the threaded hole first without the printed part. Then remove the screws and attach the printed part.
- ⚠ **Avoid wobbling with the rods in the Z-bottoms, this could cause them to break and fatally destroy the plastic parts, which could lead to injury.**

## STEP 5 Z motor assembling: parts preparation

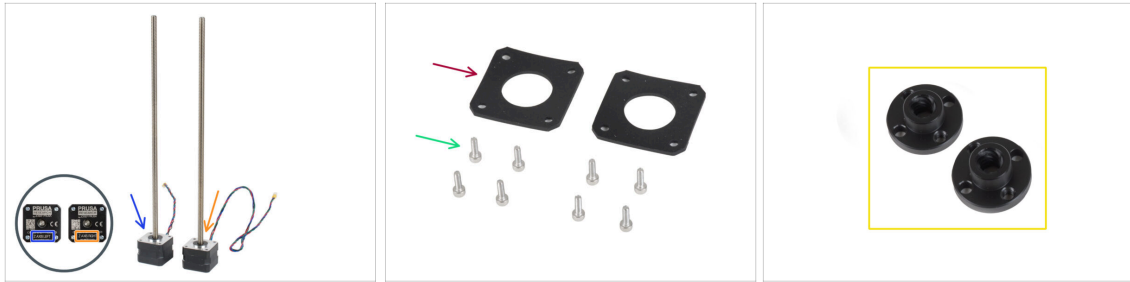

◆ **For the following step, please prepare:**

- ◆ Z motor left (labeled Z-axis left, shorter cable)
- ◆ Z motor right (labeled Z-axis right, longer cable)
- ◆ M3x10 screw (8x)
- ◆ Rubber pad 42x42x2 mm (2x)
- ◆ To avoid accidentally discarding parts, prepare the trapezoid nuts from the motor box and keep them in a safe place. You will need them in a few steps.

## STEP 6 Attaching the rubber pads

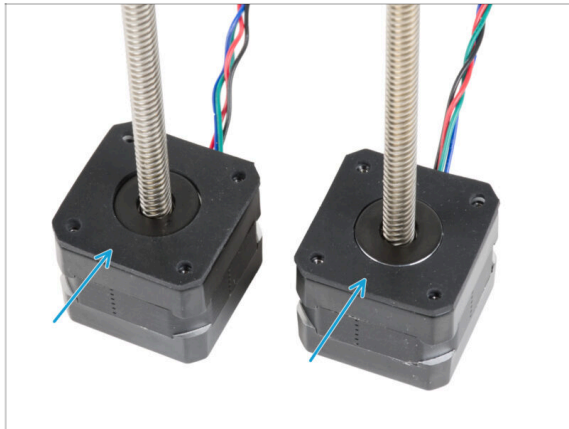

- ◆ Place both rubber pads onto the motor surface. **Make sure the holes in the pads are aligned with the holes in the motors.**

## STEP 7 Installing the Z motors

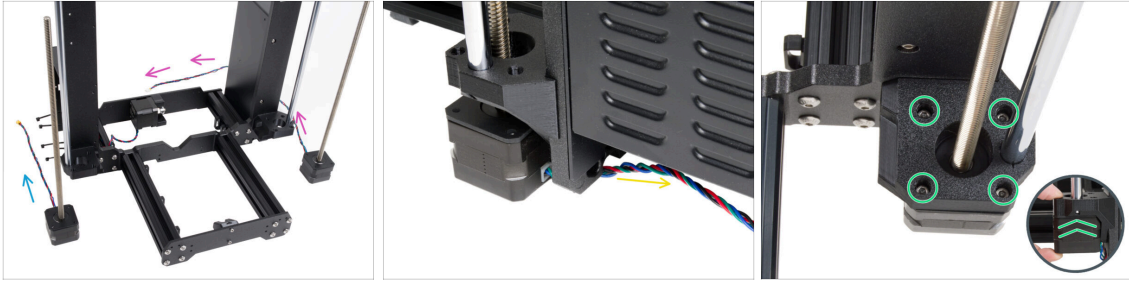

- Place the Z motor left (short cable) next to the left Z-bottom.
- Place the Z motor right (long cable) next to the right Z-bottom.
- The motor cables must guide under the frame to the PSU (right) and xBuddy Box (left).
- Push each motor through the Z-bottom and secure it with four M3x10 screws. **Do not tighten them completely at the moment.**

## STEP 8 Connecting the Z motors

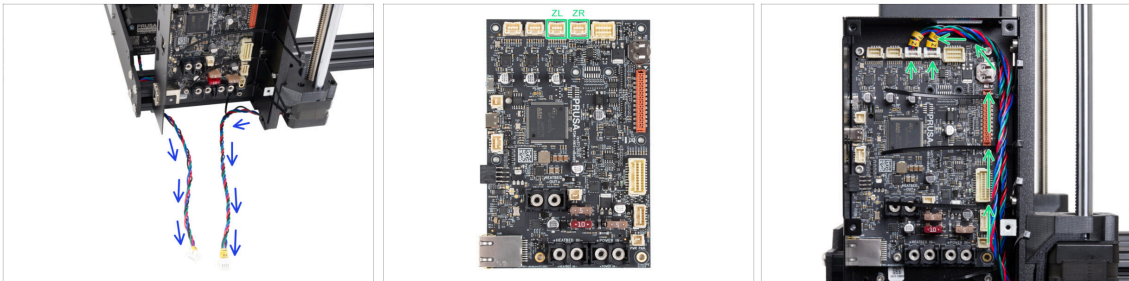

- Guide both the Z motor cables under the frame towards the xBuddy Box.
- Connect the cables to the third and fourth slots on top of the xBuddy Board. Motor cable labeled ZL connect into the left slot, ZR into the right.

**STEP 9** Mounting the X-axis assembly: parts preparation

● For the following steps, please prepare:

● Trapezoidal nut (2x)

ⓘ The trapezoidal nuts are included in the Motor kit box.

● M3x10 screw (4x)

● X-holder (1x)

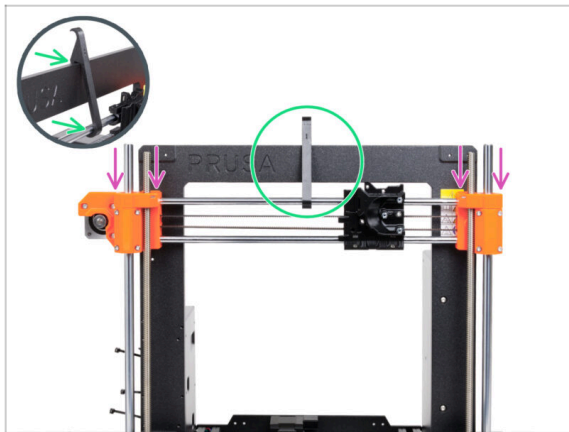
**STEP 10** Assembling the X-axis and smooth rods

● Carefully slide the X-axis assembly onto the Z-axis smooth rods.

● **Secure the position of the X-axis to the frame.** Engage the X-holder **IN THE CENTER** of the X-axis by the top smooth rod and then by the printer frame.

⚠ It is important to place the X-holder at the center of the frame and the X-axis. If not, the centering results could be inaccurate.

## STEP 11 Installing the X-axis assembly

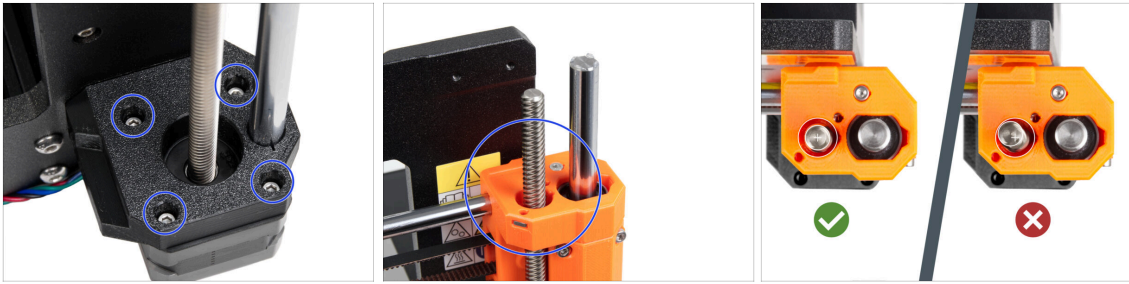

- i** Centering the threaded rods of the Z motors is important. However, it doesn't have to be perfect. See the following instructions for more:

  - Start with the **right Z motor**.
  - By carefully and gradually tightening the individual screws holding the Z motor, align the threaded rod in the X-end-idler. **Watch the threaded rod move while tightening.** Tightening the right front screw tilts the top of the rod to the rear left - and vice versa. **Tighten all screws firmly.**
  - !** Take a look at the threaded rod from the top. **The threaded rods should be close to the center of the X-end-idler hole as much as possible.** The threaded rod shouldn't touch the surface of the printed part. See the third picture.
  - PROCEED THE SAME WITH THE LEFT Z MOTOR.**

## STEP 12 Assembling the trapezoidal nuts

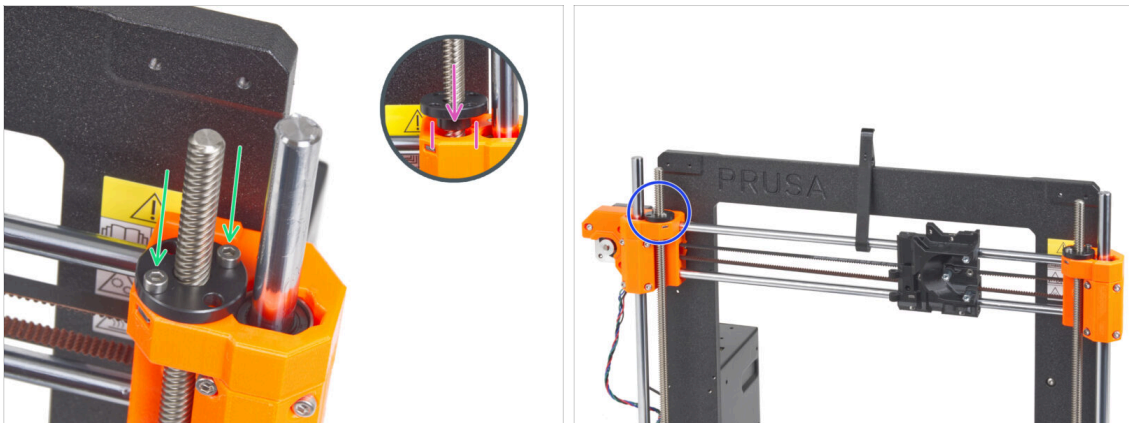

- Screw the trapezoidal nut onto the right threaded rod. **Note the correct orientation of the nut.** The smaller diameter of the nut must fit into the hole in the X-end. If it does not, the threaded rod is incorrectly centered.
- Secure the trapezoidal nut with two M3x10 screws. It does not matter which holes in the nut you use.
- i** There may be a small gap between the trapezoidal nut and the printed part. Tightening the two screws will cling the nut completely to the part.
- In the same way, install the second trapezoidal nut on the X-end-motor (left threaded rod).

## STEP 13 Installing the Z-top parts: parts preparation

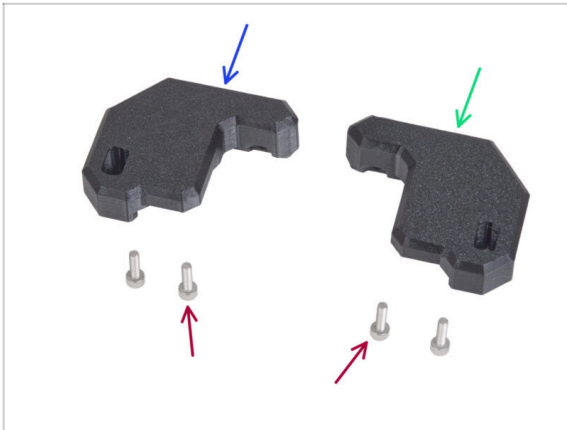

◆ For the following steps, please prepare:

- ◆ Z-top-left (1x)
- ◆ Z-top-right (1x)
- ◆ M3x10 screw (4x)

## STEP 14 Placing the Z-top parts

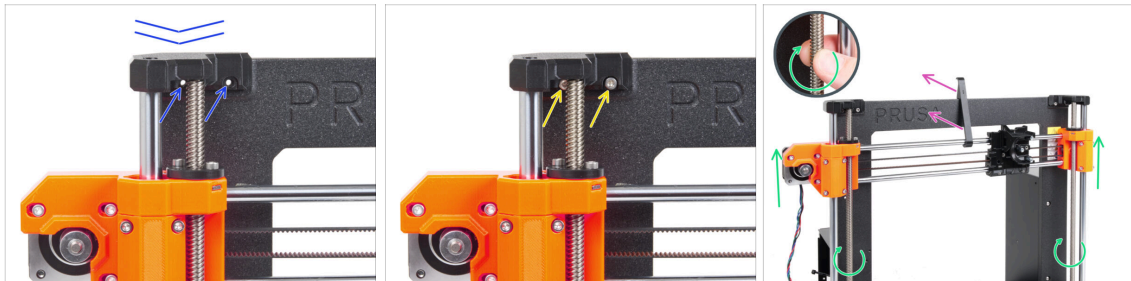

- ◆ Place the Z-top-left on the rods and align it with the frame, and align the holes in the plastic parts with the holes in the frame.
- Use two M3x10 screws to attach the Z-top-left.
  - ⚠ **Don't use excessive force during tightening.** In case of increased resistance, try to run the screws in from the other side of the frame first to "clean up" the threaded hole. Then return to the front side.
  - ⓘ Tip: move the X-axis a few centimeters down for make some space if you can't reach the screw behind the rod.
- ◆ Repeat this step on the other side of the frame with Z-top-right printed part.
- ◆ Rotate both threaded rods in parallel to move the X-axis assembly a few centimeters higher to release the X-holder.
- ◆ Remove the X-holder from the printer.

## STEP 15 LoveBoard: parts preparation

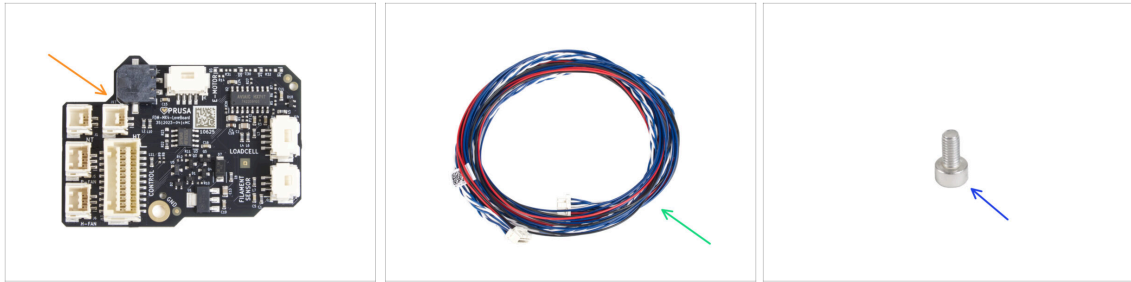

- ◆ For the following steps, please prepare:
- ◆ LoveBoard (1x) *included in the ELECTRONICS BOX*
- ◆ Extruder main cable (1x)
- ◆ M3x6 screw (1x)

## STEP 16 Assembling the LoveBoard

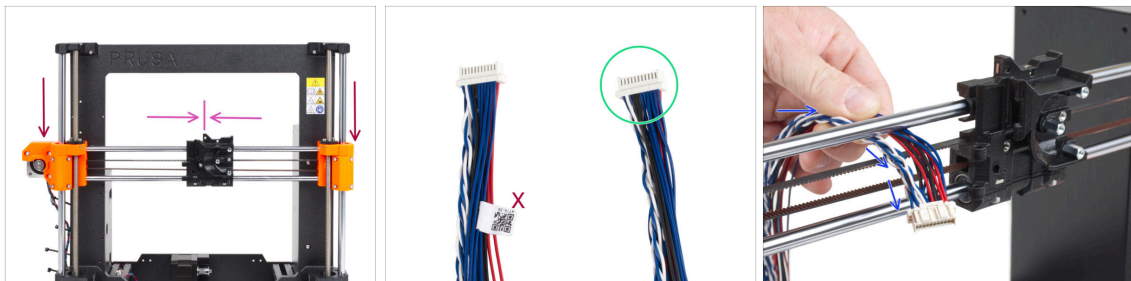

- ◆ Move the X-axis assembly to the center of the Z-axis height.
  - ⚠ **Do not push on the X-axis assembly! Turn the threaded rods to move the axis.**
- ◆ Move the X-carriage approximately to the center of the X-axis.
- ◆ Take the end of the extruder main cable without the white label.
- ◆ From the back of the printer, guide the extruder main cable to the front of the printer through the gap between the belt and the upper rod.



## STEP 17 Connecting the extruder main cable

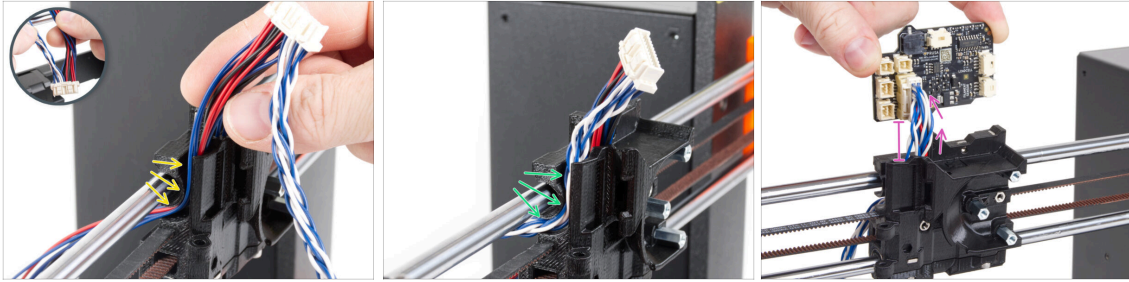

- ◆ Divide the twisted wires and straight cables from each other.
- ◆ **First, guide the straight cables** through the channel in the X-carriage.
- ◆ **Then guide the twisted cables** through the channel.
- ◆ Connect the extruder main cable to the LoveBoard. Leave the extruder main cable extended approximately 2 centimeters (0.8 inches).

## STEP 18 Mounting the extruder main cable

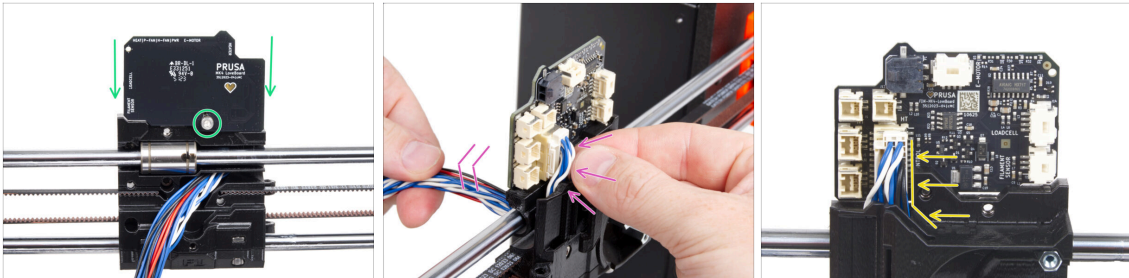

- ◆ Attach the LoveBoard to the back of the X-carriage and secure it with the M3x6 screw.
- ◆ Very gently pull on the extruder main cable bundle to reduce the bundle on the connector side. There must be a minimal loop. Otherwise, the cable will interfere with other parts in the next chapter.
- ◆ The cables must not interfere with the extruder motor compartment.

## STEP 19 Connecting the extruder main cable: parts preparation



- For the following steps, please prepare:
- X-carriage-cable-holder (1x) with the screw hole
- M3x40 screw (1x)

## STEP 20 Connecting the extruder main cable

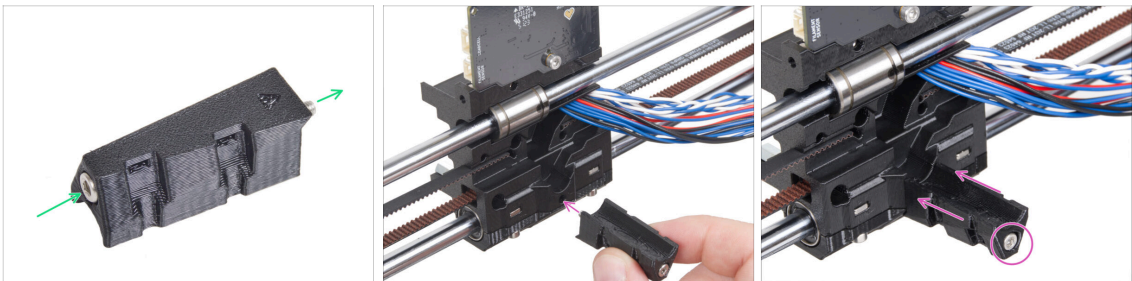

- Push the M3x40 screw through the X-carriage-cable-holder.
- Attach the X-carriage-cable-holder to the X-carriage underneath the extruder main cable and tighten the M3x40 screw.

⚠ **Do not pinch any wire of the extruder main cable!**

## STEP 21 Covering the X-carriage: parts preparation

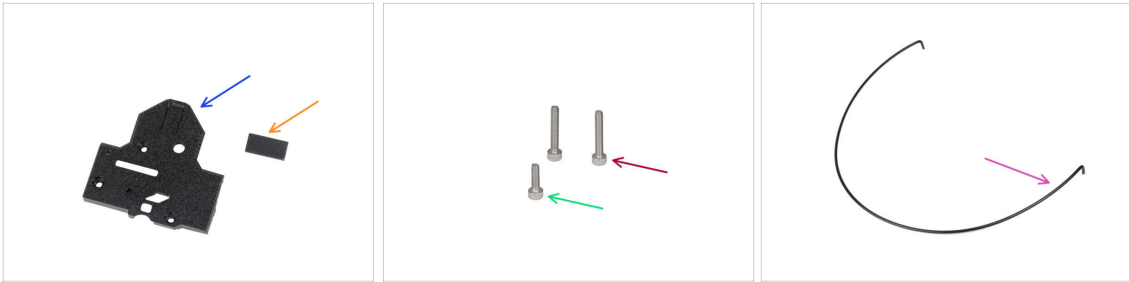

### For the following steps, please prepare:

- X-carriage-back (1x)
- Rubber pad 20x10x1 (1x)
- i The rubber pad 20x10x1 can be found in the Z-AXIS bag.
- M3x18 screw (2x)
- M3x10 screw (1x)
- Nylon 3x555 mm (1x)

## STEP 22 Covering the X-carriage: inserting the nylon filament

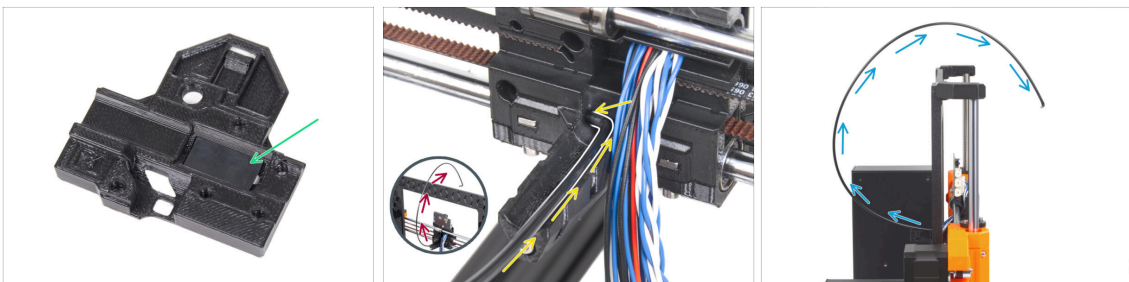

- Place the rubber pad into the rectangular pocket in the X-carriage-back.
- Insert one of the bent ends of the nylon filament into the hole located on the left side of the extruder main cable channel in the X-carriage.
- ⚠ **The nylon filament must CURVE UPWARDS. Not down, not to sides. See the detail.**
- After the nylon filament holds in the X-carriage, check that it inclines upwards as seen in the picture. If it is pointing down instead, re-install the nylon filament into the X-carriage by the other bent end and check again.

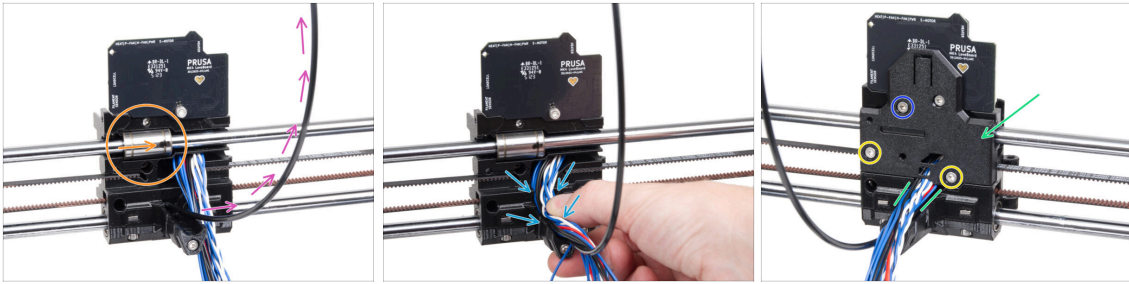
**STEP 23** Attaching the X-cover-back

- ◆ **Before we cover the back of the X-carriage, make sure that:**
  - ◆ the upper bearing is in the pocket inside the X-carriage and the marking is facing you
  - ◆ the nylon filament is pointing upwards
  - ◆ Align all bundle cables into the X-carriage-cable-holder guide channel.
  - ◆ Place the X-carriage-back on the X-carriage and arrange the main cable wires like in the picture.
- ⚠ **Be careful, no wire must be pinched!**
- ◆ Secure the X-carriage-back with two M3x18 screws.
- ◆ Insert and tighten the M3x10 screw into the upper hole in the X-carriage-back.

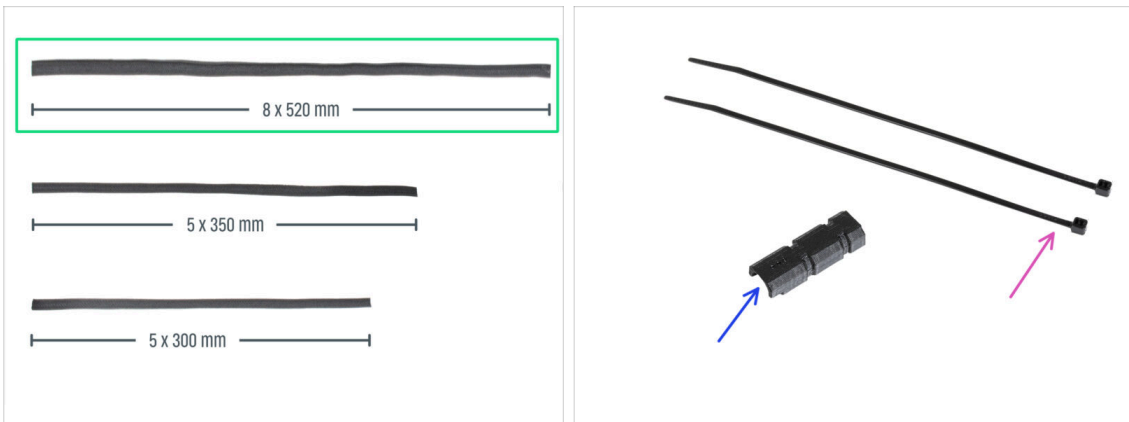
**STEP 24** Guiding the main-cable: parts preparation

- ◆ **For the following steps, please prepare:**
  - ◆ Textile sleeve 8x520 (1x)
    - ⓘ There are three different textile sleeve sizes in your kit package. You can always make sure by comparing their lengths.
    - ⓘ The ends of the textile sleeves are heat-sealed at the factory to prevent ripping. To open them, the sealed end joints must be cut or torn.
  - ◆ Zip tie (2x)
  - ◆ X-carriage-cable-holder-cover (1x)

## STEP 25 Wrapping the extruder main cable

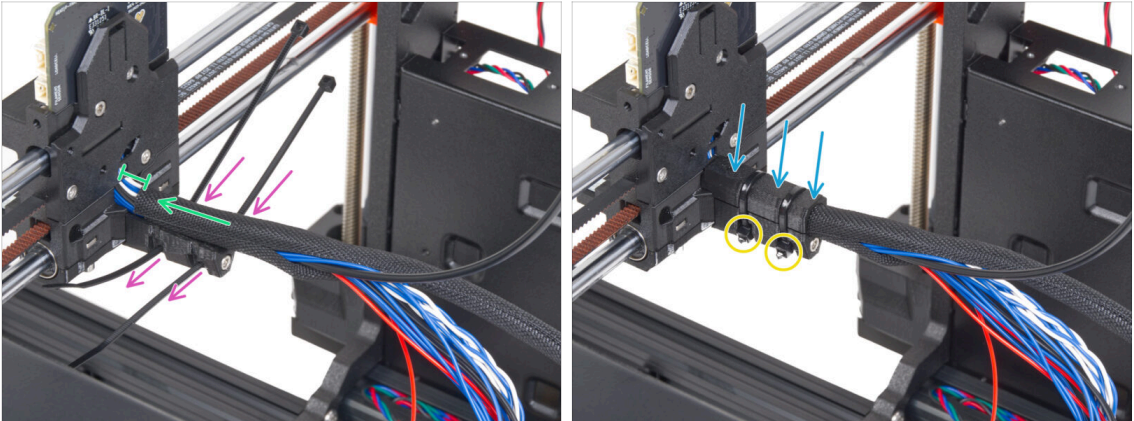

- ◆ Push two zip ties through the X-carriage-cable-holder. See the correct orientation of the zip ties.
- ◆ Wrap the extruder main cable and the nylon filament near the X-carriage with the textile sleeve. Keep a 1 cm (0.39 inches) gap between the sleeve and the X-carriage. Wrap just this part near the joint, for now, we will continue wrapping the bundle in the next step.
- ◆ Cover it with X-carriage-cable-holder-cover.
- ◆ Tighten both zip ties so that the "heads" fit into the pockets in the plastic part. Cut off the excess zip tie.

**⚠ It is important that the heads of the zip ties are seated in the pockets.** Otherwise, they may collide with the printer frame during X-axis calibration and the calibration could fail.

## STEP 26 Wrapping the textile sleeve

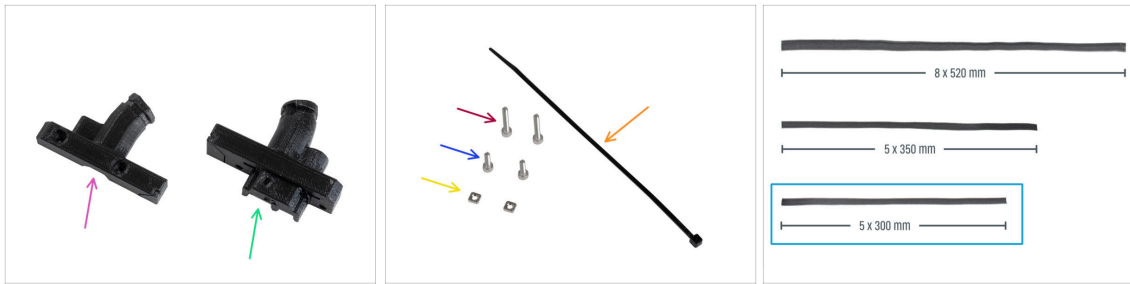

- ◆ Wrap the textile sleeve around the extruder main cable and nylon filament.
  - ◆ Proceed in a spiral motion around the bundle so that it is tightly bound together.
- ◆ Hold the cable bundle upwards while wrapping and continue until it is fully wrapped.

**STEP 27** Attaching the Ext-cable-holder: parts preparation

◆ **For the following steps, please prepare:**

- ◆ Ext-cable-holder-b (1x)
- ◆ Ext-cable-holder-a (1x)
- ◆ Zip-tie (1x)
- ◆ M3x18 screw (2x)
- ◆ M3x10 screw (2x)
- ◆ M3nS nut (2x)
- ◆ Textile sleeve 5x300 mm (1x)

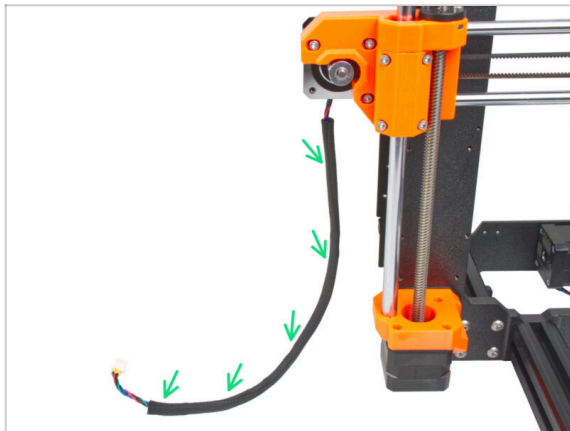
**STEP 28** Wrapping the X motor cable

- ◆ Wrap the X motor cable to the textile sleeve.
- ⓘ It's alright that the textile sleeve doesn't go over the full length of the motor cable.

## STEP 29 Attaching the Ext-cable-holder

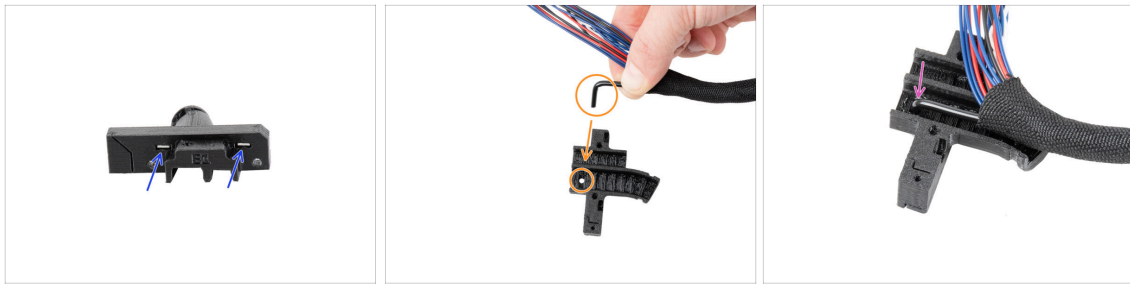

- ◆ Insert two M3nS nuts all the way into the Ext-cable-holder-a.
- ◆ Take the bent end of the nylon filament. And locate the hole in the Ext-cable-holder-a.
- ◆ Push the bent part of the nylon filament into the hole in the Ext-cable-holder-a.

## STEP 30 Assembling the Ext-cable-holder



- ◆ Guide the extruder main cable freely from the printer. Do not twist or rotate it.
  - ◆ Guide the X motor cable freely from the printer.
  - ◆ Insert the extruder main cable in the cable channel in the Extr-cable-holder-a.
  - ◆ Take the X motor cable and guide it **over the extruder main cable** through the left channel in the Ext-cable-holder-a.
- ⚠ Guiding the X motor cable behind the main cable could cause problems with axis travel when printing.

### STEP 31 Covering the Ext-cable-holder



- ◆ Cover the cables with the Ext-cable-holder-b and secure it with two M3x18 screws.
- ◆ Secure the Ext-cable-holder together with the zip tie in the groove. Tighten up the zip tie and cut off the excess of the zip tie.

### STEP 32 Mounting the Ext-cable-holder

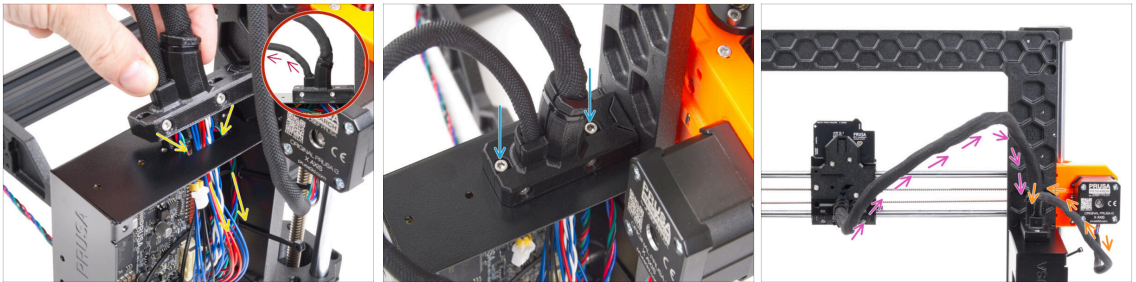

- ◆ Push the X-axis motor cable and the extruder main cable through the hole in the xBuddy box to the electronics.
- ⚠ Double-check that the **X motor cable does not guide behind the extruder main cable**. Compare it with the picture.
- ◆ Attach the Ext-cable-holder onto the xBuddy box with the two M3x10 screws.
- ◆ Leave the cables free in the xBuddy box for now. We will connect them later on.
- ◆ According to the third picture, compare the guiding of the extruder main cable. Note the curve of the cable guide.
- ◆ Compare the guiding of the X motor cable.



### STEP 33 Reward yourself!

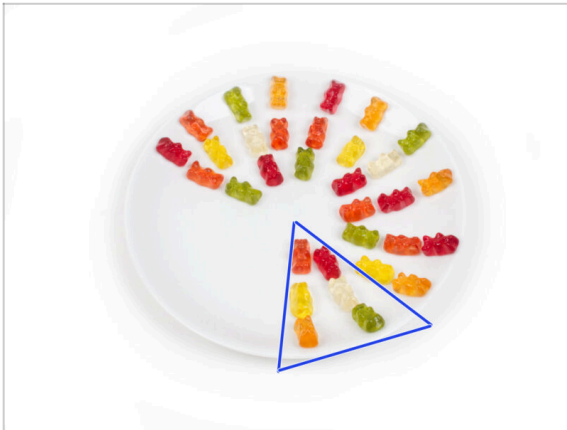

◆ Eat six gummy bears.

ⓘ **Did you know that** in 2014, a gummy bear-inspired emoji was added to the Unicode Standard, allowing gummy bear enthusiasts to express their love for the candy in digital conversations.

### STEP 34 Here it is!



- ◆ Compare your build with the picture.
- ◆ Everything is right? Congratulations! You have successfully assembled the Z-axis with some other small things.
- ◆ So, let's continue with the next chapter: **5. Nextrunder assembly**

## 5. Nextruder assembly

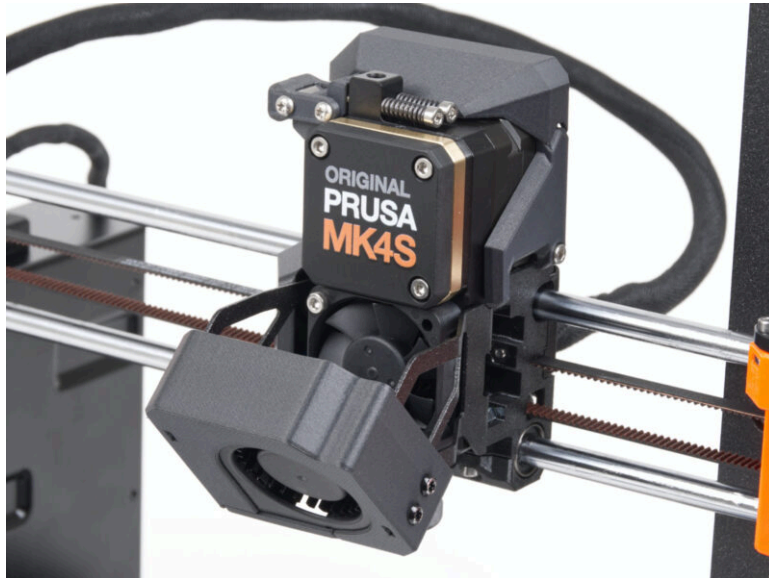

## STEP 1 Tools necessary for this chapter

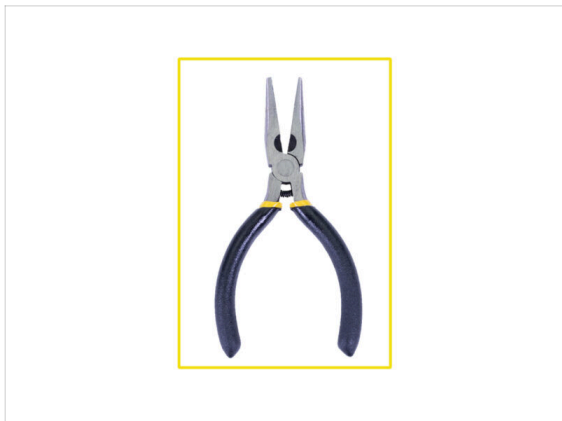
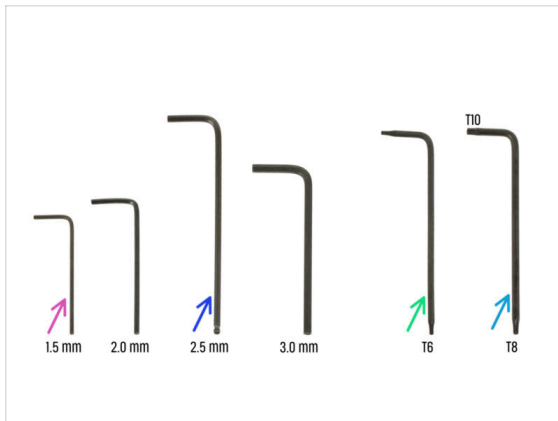

● For this chapter, please prepare:

- 1.5mm Allen key
- 2.5mm Allen key
- Torx key TX6
- Torx key TX10/8
- Needle-nose pliers

## STEP 2 Nextruder idler assembly: parts preparation

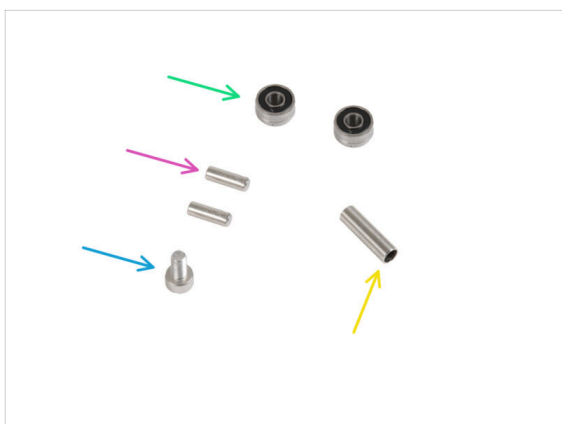
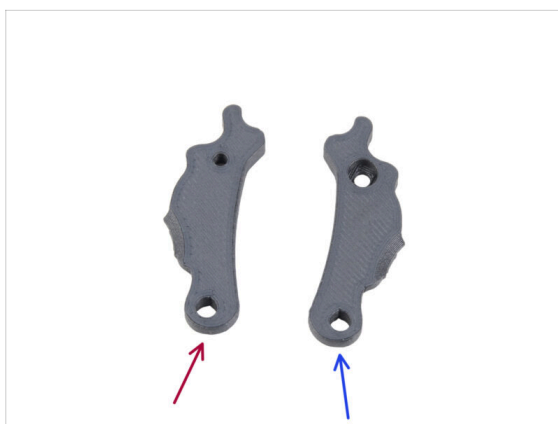

● For the following steps, please prepare:

- Idler-lever-a (1x)
- Idler-lever-b (1x)
- Bearing 693 2RS (2x)
- Pin 2.9x8.5 (2x)
- M3x6 screw (1x)
- Tubular spacer 13.2x3.8x0.35 (1x)

**STEP 3** Assembling the extruder idler

- Place both bearings into the Idler-lever-a.
- Insert the pin 2.9x8.5 into each bearing 693 2RS, as seen in the picture.
- Close it up with the Idler-lever-b part and secure it with the M3x6 screw. **Do not overtighten the screw.** Both bearings must be able to rotate without significant resistance.
- From the same side, push the tubular spacer into the assembly. The "bottom" of the tubular spacer must be flush with the bottom part of the Idler assembly.

**STEP 4** Assembling the extruder: parts preparation I.

- **For the following steps, please prepare:**
- PG-assembly (1x)
  - ⓘ **Note:** There are two types of planetary gear assemblies shipped. Both are functionally identical, so assembly remains the same. The latest version has several holes around the main gear.
- Heatsink assembly (1x)
- Main-plate (1x)
- PG-ring (1x)
- PG-assembly-adapter (1x)
- ⓘ The list continues in the next step...

## STEP 5 Assembling the extruder: parts preparation II.

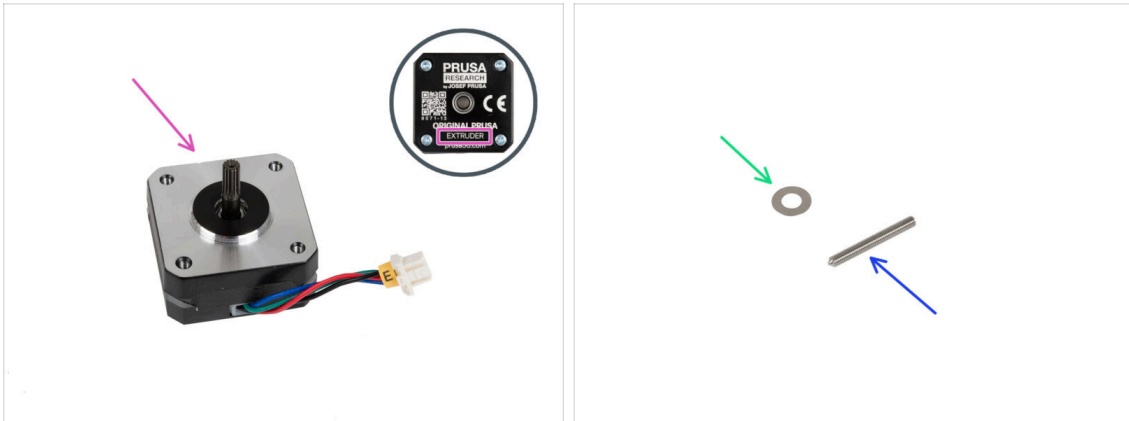

- ◆ Extruder motor (1x)
- ◆ Spacer 5x10x0.1 mm (1x)
- ◆ Socket set screw M3x25 (1x)

## STEP 6 Assembling the extruder



- ◆ Place the 5x10x0.1 spacer over the shaft on the extruder motor.
- ◆ Place the heatsink on the extruder motor. Note the orientation of both parts.
  - ◆ The motor cable must be facing "up".
  - ◆ The heatsink cables must be on the right side.
- ◆ Place the main-plate on the heatsink. Note the orientation of the part. Use the cutout as a guide.

⚠ Before proceeding to the next step, make sure that the 5x10x0.1 spacer is placed on the extruder motor.

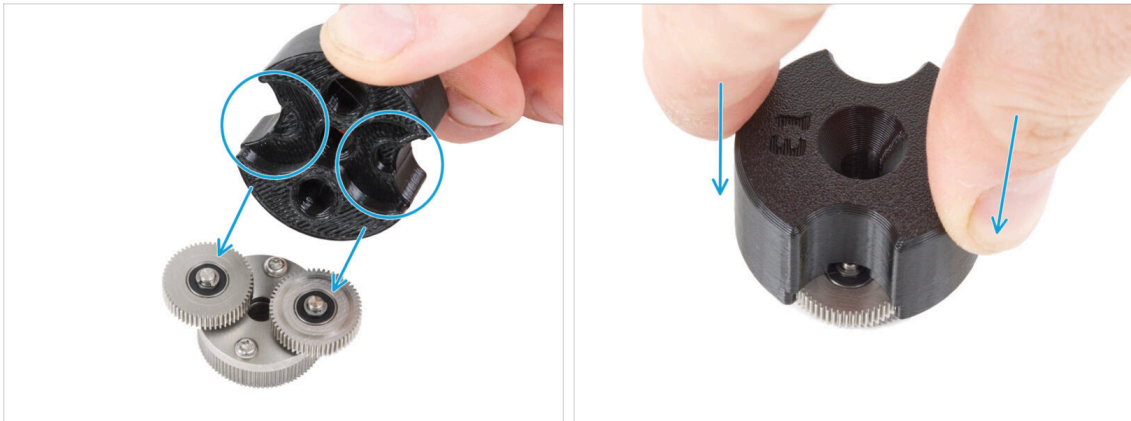
**STEP 7** Assembling the gearbox

- i** The following instructions need to be done correctly and carefully. Achieve better understanding and successful assembly by watching the video alongside the guide: [prusa.io/PG-assembly](https://prusa.io/PG-assembly)
- After watching the video, follow the steps in this guide.
  - Attach the PG-assembly-adaptor on the PG-assembly. Note the pockets for the gears in the adapter.

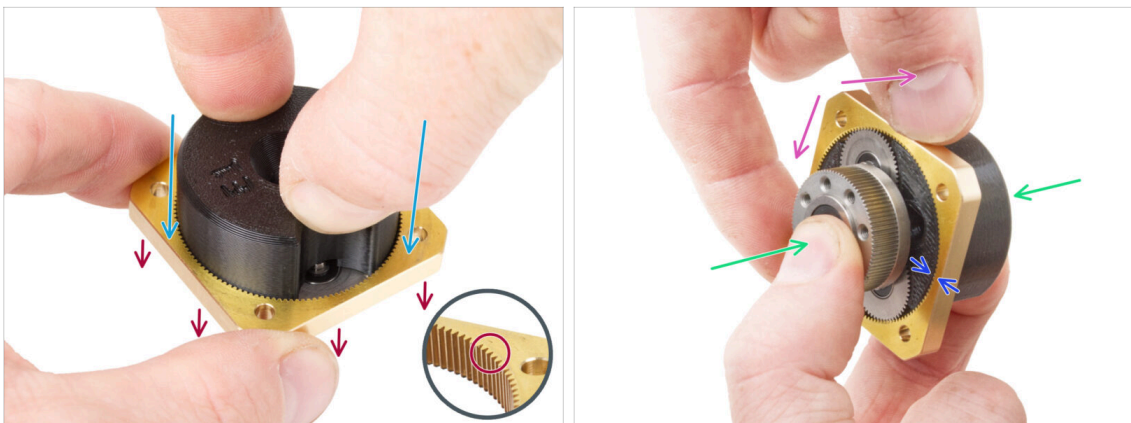
**STEP 8** Assembling the PG-ring

- ⚠ Do not assemble the gearbox without the PG-assembly-adaptor. This tool is intended to ensure that the gears are correctly fit together.**
- Slide the PG-ring onto the adaptor.
    - Note there is a chamfer on one side of the PG-ring teeth. This side must be facing down (to the PG-assembly).
  - Grasp the entire assembly in one hand so that it can be rotated with the PG-ring.
  - With the other hand, slide the PG-ring onto the PG assembly in a wobbling motion (move the PG-ring left and right repeatedly) - a quarter turn is enough.
  - Stop when the surfaces of the gears are approximately flush with the surface of the PG ring.

## STEP 9 Assembling the PG-assembly

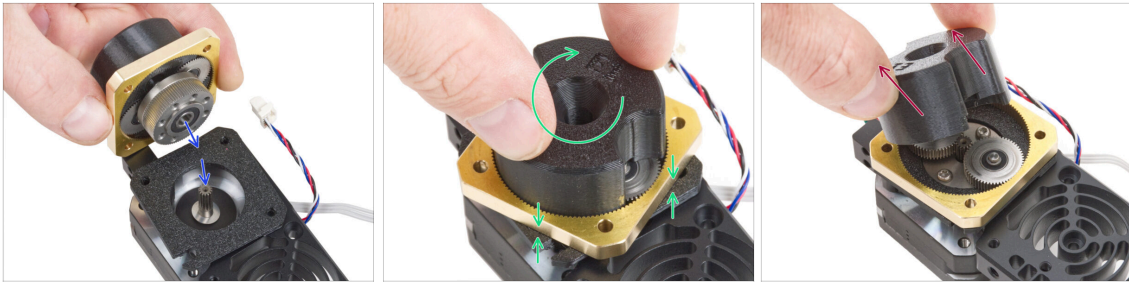

**⚠ Proceed very carefully in this step.**

- ◆ Maintain the position of the PG-assembly and attach it on to extruder motor shaft.
- ◆ Very gently and freely rotate with the whole PG assembly (PG-assembly-adapter, PG-assembly and PG-ring) until it drops down so that there is no gap between the assembly and the main-plate. **Do not push on the assembly.**
- ◆ Remove the PG-assembly-adapter.

## STEP 10 Checking the PG-assembly

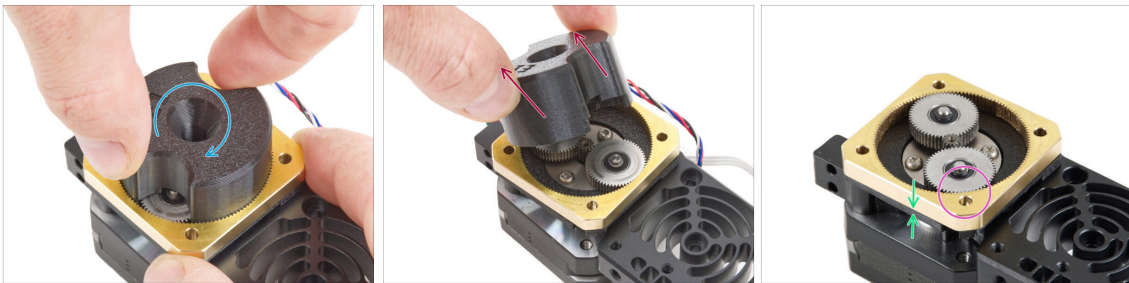

- ◆ Attach the PG-assembly-adapter back on the PG-assembly again to verify that all parts are properly seated.
- ◆ Rotate with the PG-assembly-adapter. **The PG assembly must be easy to rotate without having to exert much force.**
- ◆ Remove the PG-adapter. You will no longer need it during assembly. We recommend keeping it for maintenance.
- ◆ Ensure that the PG-assembly is not sticking out above the PG-ring. It should be positioned lower than the level of the PG-ring's surface or at the same level as the ring.
- ◆ Ensure that the gap between the PG-ring and the Main-plate is minimal. If a significant gap is observed, disassemble the planetary gear assembly and reposition it.

## STEP 11 Assembling the Nextruder idler

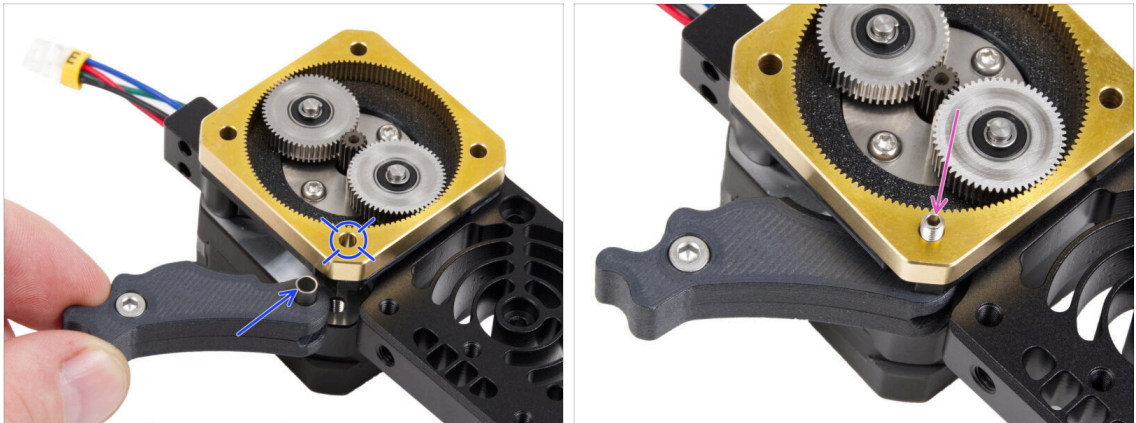

- ◆ Insert the idler assembly between the PG-ring and the extruder motor. There is a cutout for the spacer in the main-plate. Line up the idler spacer with the hole in the PG-ring.
- ◆ Secure both parts with the socket set screw 3x25. **Do not overtighten the screw! The screw protrudes from the PG-ring after tightening.**

## STEP 12 Gear lubrication: parts preparation



- ◆ **For the following steps, please prepare:**
- ◆ PG-case (1x)
- ◆ M3x25 screw (3x)
- ◆ Lubricant (1x) *included in Fasteners & ELE box*
- ◆ Several paper towels to wipe grease from your hands.



### STEP 13 Lubricating the gear



- ◆ Remove the cap from the lube. Use the spike on the opposite side of the cap to pierce a hole in the lube tube opening.
- ◆ Squeeze a small amount of lubricant onto the tip of the zip tie, then spread it over the gears.
- ◆ Apply a small amount of Prusa Lubricant **all around** the PG-ring and PG-assembly teeth.
- ◆ Close the lubricant; it is no longer needed for the assembly.

### STEP 14 Covering the planetary gear

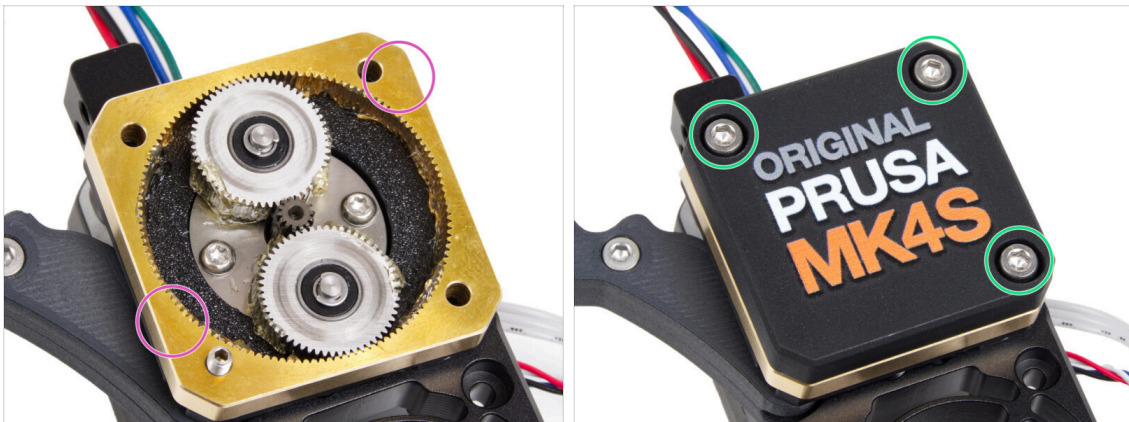

- ◆ Using the paper towel, wipe off the lubricant residue from the face surface of the PG-ring.
- ◆ Place the PG-case on the gearbox and secure it with three M3x25 screws. **Do not tighten them completely** at this moment.
- ⓘ The screws on the PG-case will be completely tightened during the self-test in the final chapter.

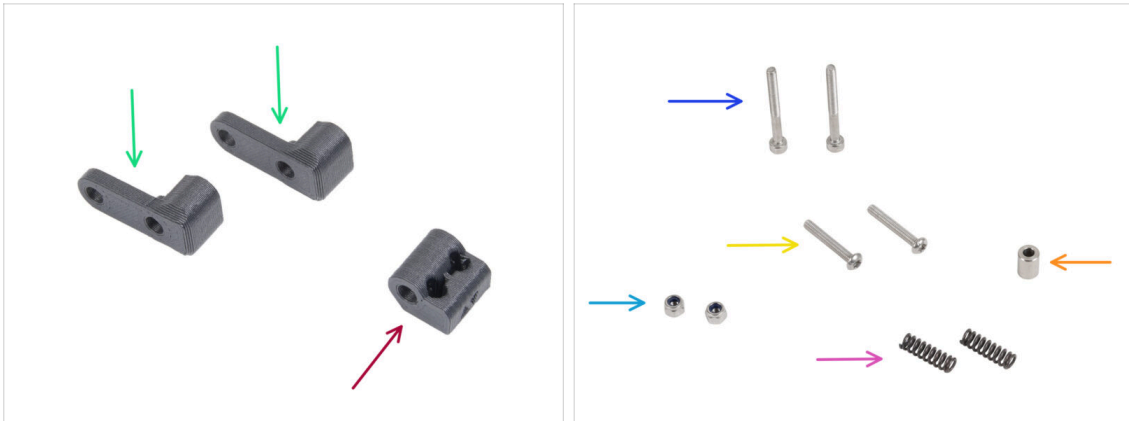
**STEP 15** Assembling the Idler-swivel: parts preparation

● For the following steps, please prepare:

- Idler-swivel (2x)
- Idler-nut (1x)
- M3x30 screw (2x)
- M3x20rT screw (2x)
- M3nN nut (2x)
- Spring 15x5 (2x)
- Spacer 6x3.1x8 (1x)

**STEP 16** Assembling the Idler-swivel

- Push the M3x20rT screw all the way through one of the idler-swivel.
- Slide the spacer onto the screw.
- Place the second idler-swivel from the opposite side on the screw.
- From the other side, attach the M3nN nut onto the screw. Hold the nut using the universal wrench and tighten the screw. **Tighten just lightly!** The spacer must rotate freely.

## STEP 17 Assembling the Idler-nut

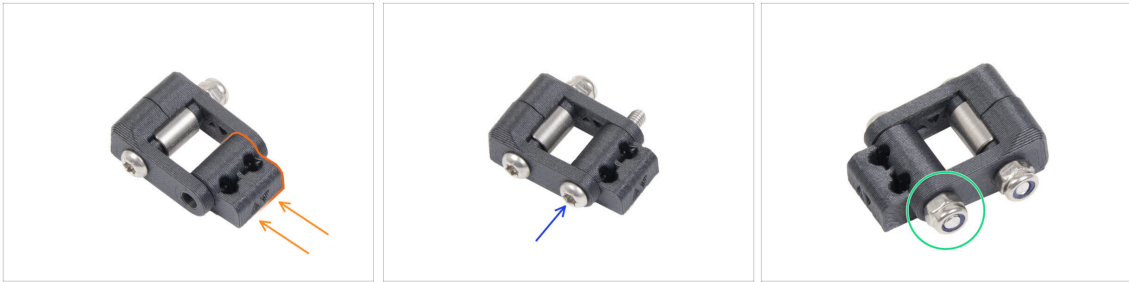

- ◆ Insert the Idler-nut into the Idler-swivel assembly. Make sure that both parts are oriented correctly according to the picture.
- ◆ Secure both parts together by inserting the M3x20rT screw from the same side, like the first screw.
- ◆ Secure the screw with M3nN nut. **Do not overtighten the nut.** It must be possible to move with the Idler-swivel on the Idler-nut.

## STEP 18 Mounting the Idler-swivel assembly

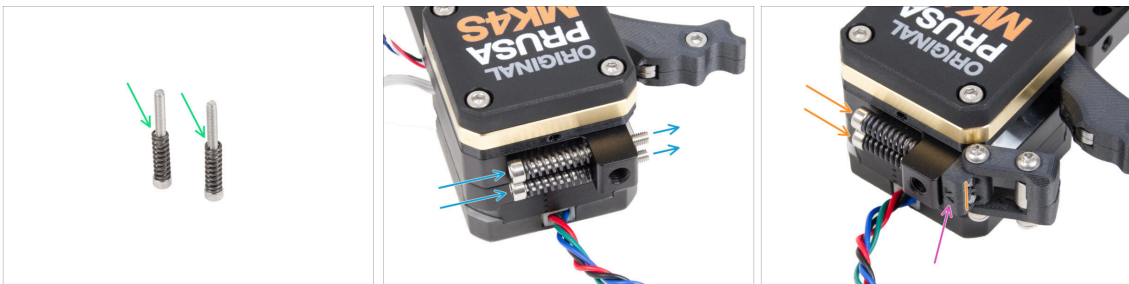

- ◆ Attach the spring 15x5 on both M3x30 screws.
- ◆ Push the two screws with the springs through the holes in the protrusion on the heatsink. There are no threads inside.
- ◆ Attach the Idler-swivel assembly on the screws. See the correct orientation of the Idler-nut. The side with version marking must be visible. See the picture.
- ◆ Tighten both screws. **Stop tightening as soon as the screw tips reach the front face of the idler nut.**

## STEP 19 NTC thermistor & fan holder: parts preparation

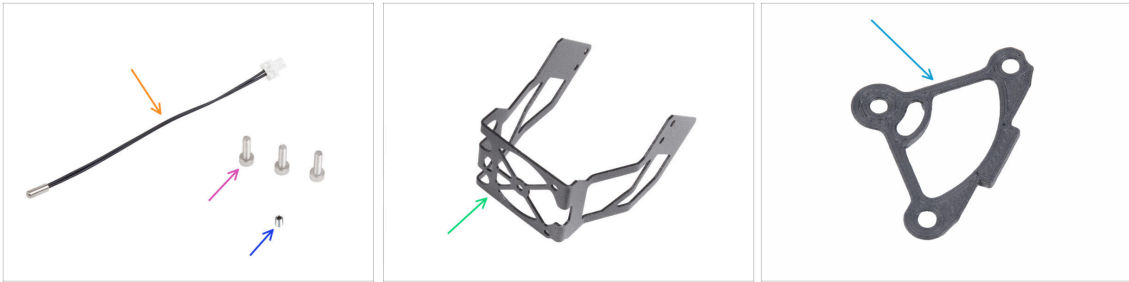

◆ For the following steps, please prepare:

- ◆ NTC thermistor 90 mm (1x)
- ◆ M3x12 screw (3x)
- ◆ M3x4T grub screw (1x)
- ◆ MK4S fan holder (1x)
- ◆ Heatsink spacer (1x)

## STEP 20 Assembling the NTC thermistor

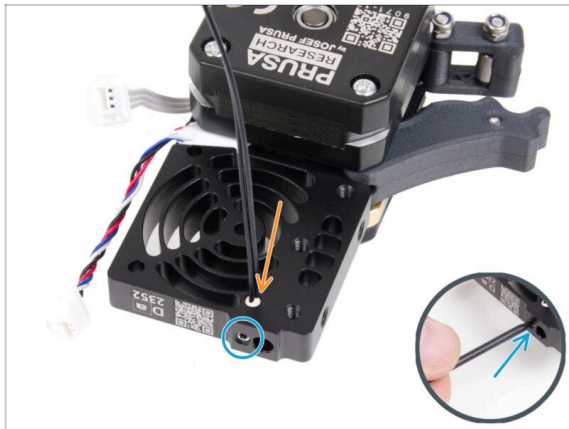

- ◆ On the **extruder motor side**, insert the NTC thermistor into the hole in the heatsink.
- ◆ Secure it with the M3x4T grub screw. Screw it all the way in. **Tighten gently, but firmly** using two fingers and the short side of the T6 Torx key. Applying more force may cause permanent damage to the thread.

## STEP 21 Assembling the Nextruder



- ◆ From the front side of the Nextruder (side with the printer logo pg-case), insert three M3x12 screws in the heatsink.
  - ◆ From the opposite side of the Nextruder, fit the heatsink spacer onto the three screws.
    - ◆ Make sure the protrusion protrudes towards you (like the screws).
  - ◆ From the extruder motor side of the heatsink, attach the MK4S fan holder to the heatsink.
- ⚠ **Avoid pinching the NTC thermistor cable.** Guide it through the cutout as shown in the detail.

## STEP 22 Attaching the Nextruder

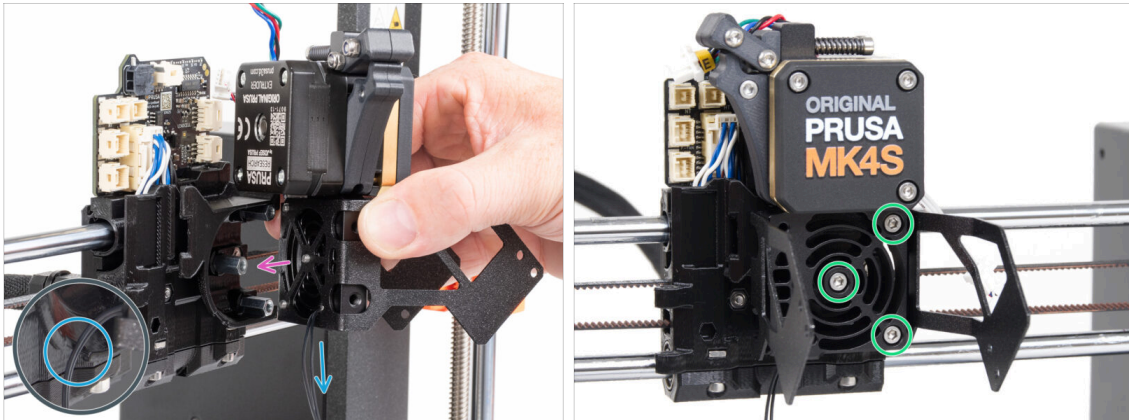

- ◆ Place the Nextruder assembly onto the spacers on the X-carriage. Line up the three screws with the three spacers.
  - ◆ There is a cutout in the plastic part. **Guide the thermistor cable through this cutout.**
- ⚠ **DO NOT PINCH ANY OF THE CABLES!**
- ◆ Align the heatsink screws with the spacers on the X-carriage and join both parts together by tightening them. Start with the middle one.

## STEP 23 Connecting the NTC thermistor

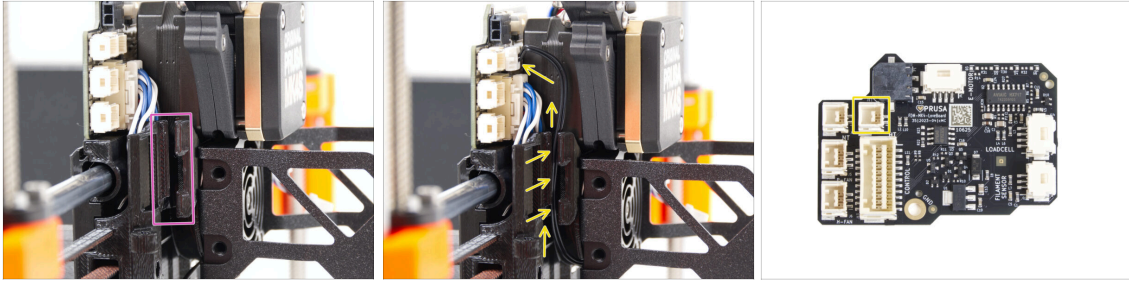

- ◆ Locate the cable channel on the left side of the X-carriage. We will guide some of the cables through this channel in the following steps
- ◆ Guide the NTC thermistor through the cable channel in the X-carriage up to the LoveBoard and connect it to the top right slot.

## STEP 24 Assembling the hotend fan: parts preparation

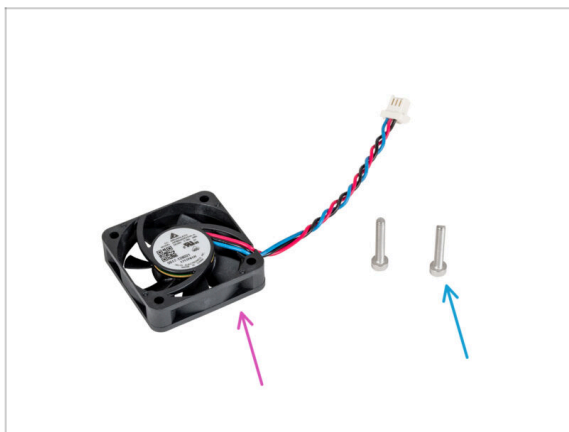

- ◆ For the following steps, please prepare:
- ◆ Hotend fan (1x)
- ◆ M3x18 screw (2x)

## STEP 25 Assembling the hotend fan

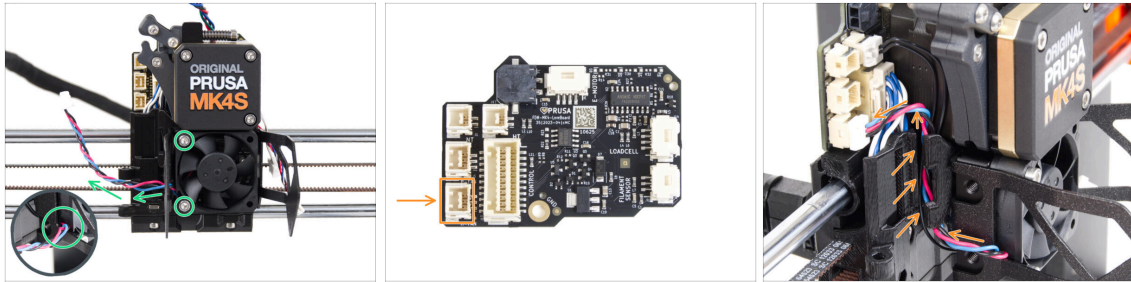

- ◆ Attach the hotend fan onto the heatsink with two M3x18 screws on the left side. **Tighten the screw gently, but firmly**, otherwise the plastic housing may crack. The cable must be pointing towards the lower-left corner.
  - ⚠ There is a sticker on the hotend fan, the sticker must be on the rear side of the fan - not visible.
- ◆ Guide the fan cable through the cutout in the fan holder.
- ◆ Guide the fan cable through the cable channel up and connect it to the **lower slot** on the LoveBoard.

## STEP 26 Print fan blower: parts preparation

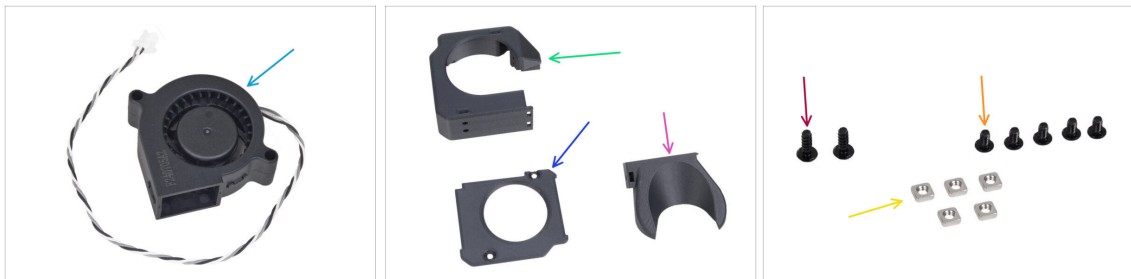

- ◆ **For the following steps, please prepare:**
- ◆ MK4S Print fan blower (1x)
- ◆ Fan-case (1x)
- ◆ Fan-case-cover (1x)
- ◆ Fan-shroud (1x)
- ◆ 3x8sT screw (2x)
- ◆ M3x5rT screw (5x)
- ◆ M3nS nut (5x)

**STEP 27** Assembling the print fan case

- ◆ From the flat surface of the Fan-case, insert two M3nS nut all the way into the holes.
- ◆ **Double-check** from the side that the inserted nut is aligned with the hole in the part.
- ◆ From the opposite side, insert two M3nS nuts all the way into the holes. Check that nuts are fully inserted.
- ◆ Insert one M3nS nut into the hole in the Fan-shroud.

**STEP 28** Assembling the print fan blower

- ◆ Insert the MK4S print fan blower into the print fan blower case.
- ◆ Guide the print fan blower cable through the cable channel in the Fan-case.
- ◆ Close the fan with Fan-case-cover.
- ◆ Secure the cover with two 3x8sT screws.
- ◆ **i** The screws cut thread directly into the plastic, so there might be some resistance.



## STEP 29 Assembling the fan shroud



- i Attach the Fan-shroud to the print fan blower assembly. Notice two teeth on the fan shroud and two rectangular holes in the blower assembly.
- First, insert those teeth into the rectangular cutouts.
- Close the Fan-shroud and secure it with the M3x5rT screw.
- ⚠ **Tighten the screw gently** until it resists significantly. Do not overtighten; otherwise, it can crack the parts.

## STEP 30 Mounting the print fan blower assembly

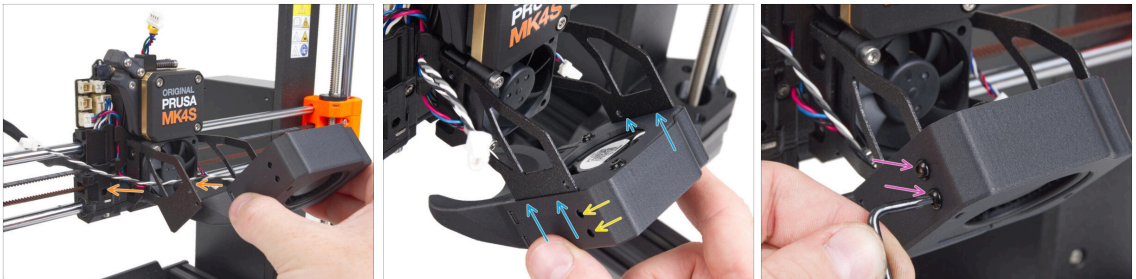

- Take the print fan blower assembly and guide the fan cable through the cutout on the left side of the fan holder.
- 📌 Use the same cutout through which the heatsink fan cable already guides.
- Slide the side pockets of the print fan blower assembly onto the two “forks” of the fan holder.
- Ensure that the holes of both parts are aligned.
- From the left side of the fan holder, secure both parts together using two M3x5rT screws.

## STEP 31 Connecting the print fan blower

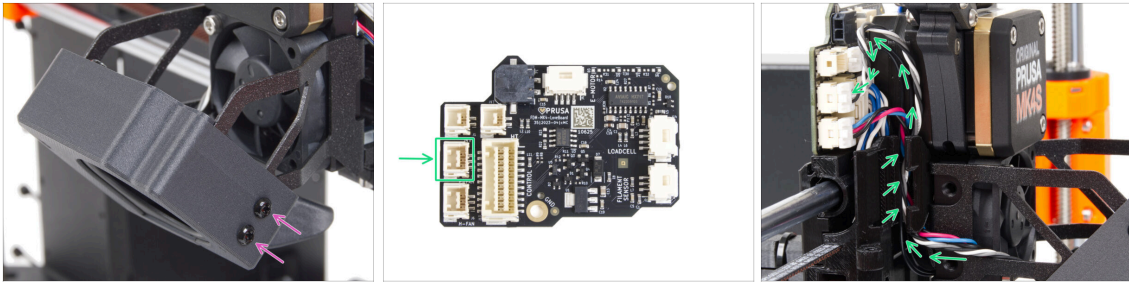

- ◆ From the right side of the fan holder, secure both parts together using two M3x5rT screws.
- ◆ Guide the print fan blower cable through the cable channel in the X-carriage and plug the connector to the middle slot on the LoveBoard.

## STEP 32 Inserting the hotend assembly: parts preparation

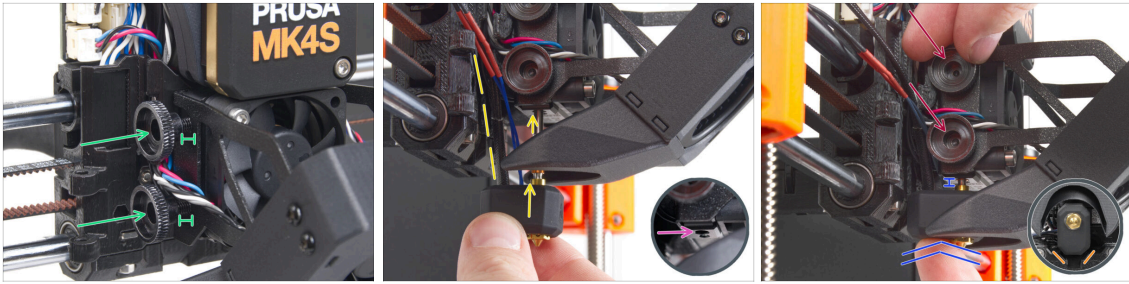

- ◆ For the following steps, please prepare:
- ◆ Hotend assembly (1x)
- ◆ Thumb screw (2x)

**STEP 33** Inserting the hotend assembly

- ◆ Insert two thumb screws into the heatsink. **Do not tighten them completely.** Two turns are enough for now.
- ◆ Look closely at the underside of the heatsink and find the hole for the hotend assembly.
- ◆ Insert the hotend assembly tube in the hole and slide the whole thing into the heatsink.
- ◆ Push the hotend assembly all the way into the heatsink. There should be approximately a 2 mm gap between the heatsink and the brass part of the nozzle.
- ◆ While pushing the hotend assembly in, **firmly tighten both thumb screws.**
  - ⚠ **Avoid pinching any cable between the screws and the heatsink!**
- ◆ From the underside, check that the hotend is oriented correctly. It must fit between the cutouts in the X-carriage.

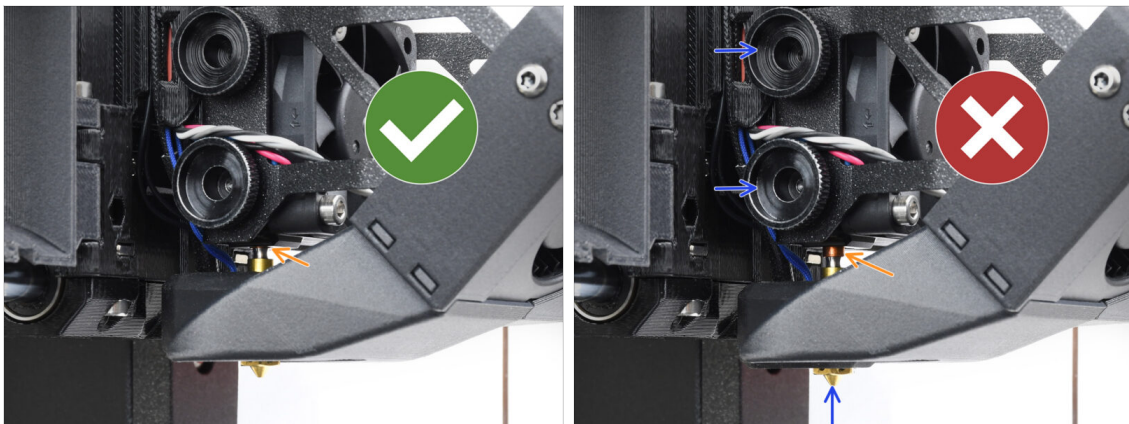
**STEP 34** Nozzle insertion check

- ◆ Verify that the nozzle is fully inserted. The copper ring on the nozzle should not be visible if it's properly seated.
- ⓘ If not fully inserted, poor heat transfer may occur, potentially leading to issues like nozzle clogs.
- ◆ To adjust the nozzle position, loosen the thumbscrews, reposition the nozzle, and then retighten the screws, while pushing the hotend assembly up.

## STEP 35 Connecting the hotend cables

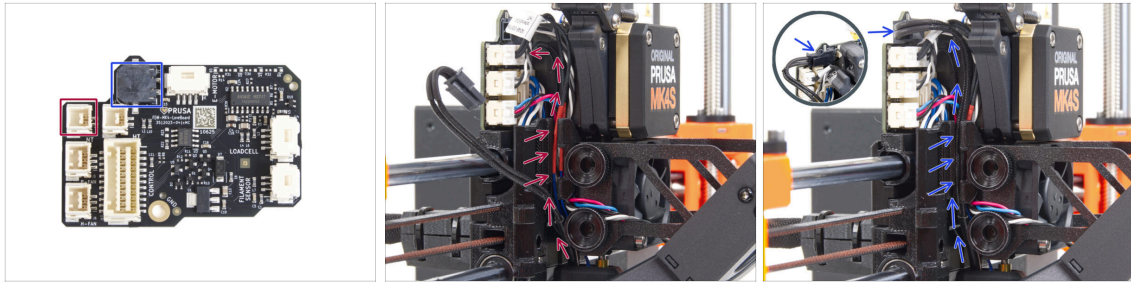

- ◆ Guide the hotend thermistor through the cable channel in the X-carriage and connect it to the LoveBoard.
- ◆ Guide the hotend heater through the cable channel in the X-carriage and connect it to the LoveBoard.

## STEP 36 Fan door cover: parts preparation

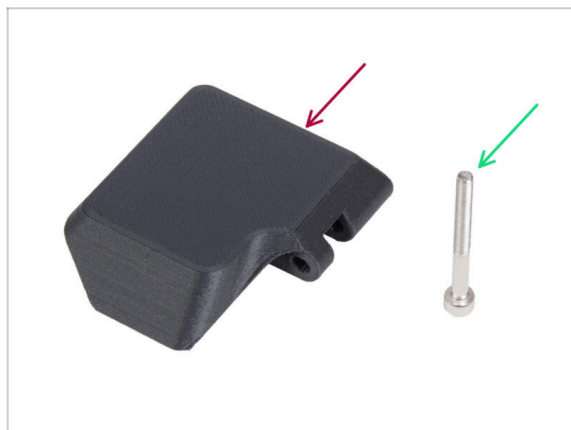

- ◆ For the following steps, please prepare:
- ◆ Fan-door-cover (1x)
- ◆ M3x30 screw (1x)

## STEP 37 Attaching the Fan-door-cover

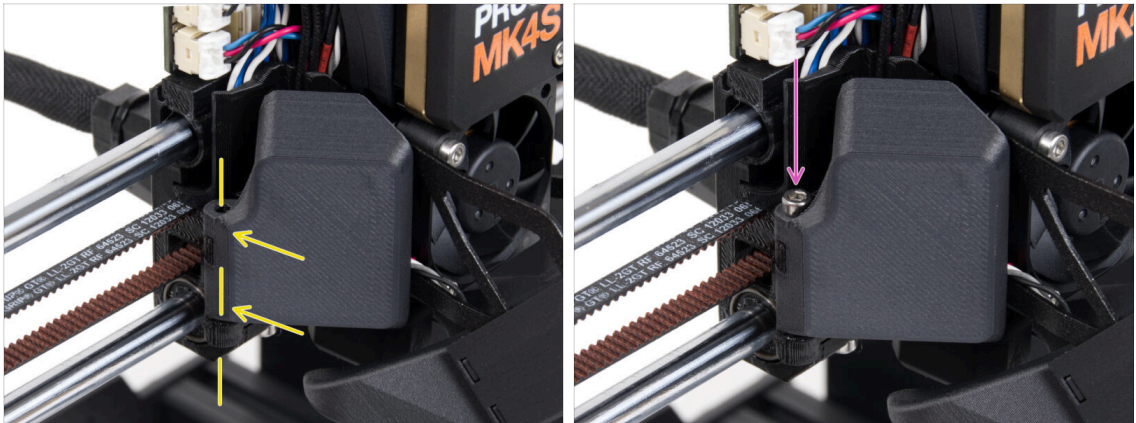

- Attach the Fan-door-cover hinge into its counterpart in the X-carriage. Holes in both parts must be aligned.
- Insert the M3x30 screw in the hinge on the fan-door. Fully tighten the screw, then loosen it by a quarter turn. **The fan-door must move freely!**

## STEP 38 Connecting the extruder cables

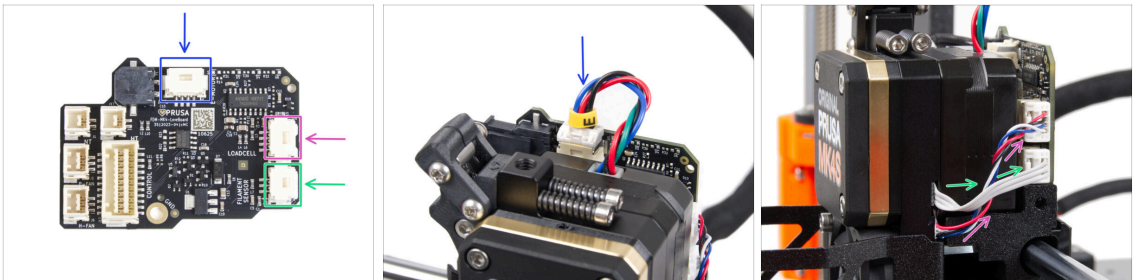

- Connect the Extruder motor cable to the connector on the top side of the LoveBoard.
- Connect the Loadcell cable coming from the right of the heatsink to the upper slot on the right side of the LoveBoard.
- Connect the filament sensor cable to the lower slot on the right side of the LoveBoard.

## STEP 39 LoveBoard: Wiring check

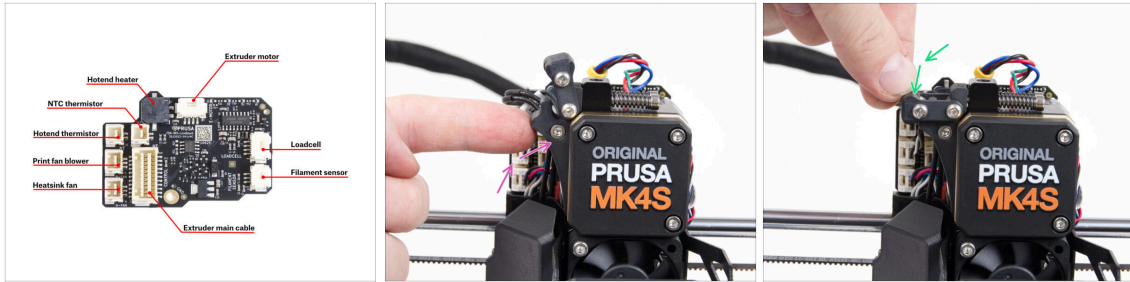

**⚠ Before covering the electronics, check the connection of all cables. Click on high-resolution preview in the top left corner.**

**⬛ Close the idler mechanism before proceeding to the next step if you haven't already done so. Use the following sequence:**

- ◆ Close the extruder idler to the extruder
- ◆ Close the idler-swivel and lock it over the extruder idler assembly

## STEP 40 Covering the LoveBoard: parts preparation

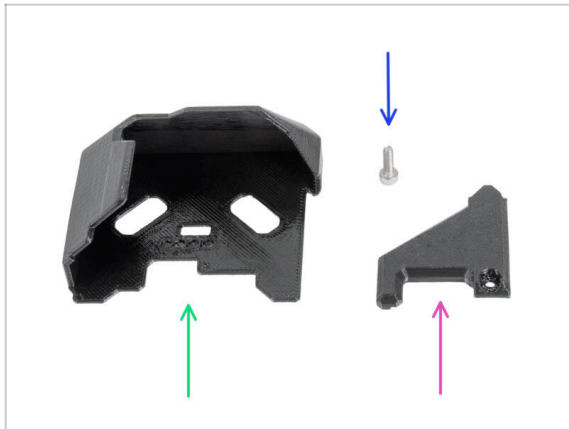

**⬛ For the following steps, please prepare:**

- ◆ LoveBoard-cover (1x)
- ◆ LoveBoard-cover-right (1x)
- ◆ M3x10 screw (1x)

## STEP 41 Covering the LoveBoard: side cover

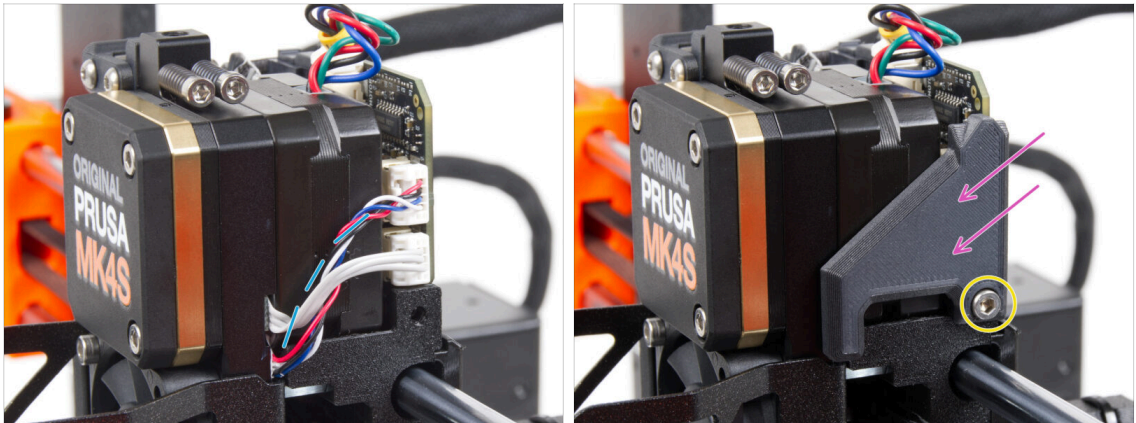

- Curve and arrange the cables on the right side of the extruder as you can see in the picture.
- Cover the cables with the LoveBoard-cover-right.
  - ⚠ **Do not pinch the cables!**
- Secure it with the M3x10 screw.
  - ⚠ **Make sure the LoveBoard-cover-right fits snugly against the right side of the extruder.** If not, it may cause the X-axis test to fail during the self-test because it will prevent the X-carriage assembly from moving all the way to the right.

## STEP 42 Covering the LoveBoard: top cover

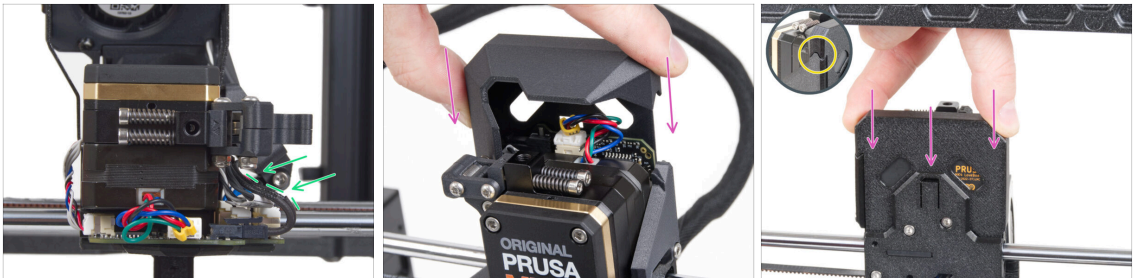

- Push all cables to the extruder to make more space around them. See the picture.
- Slide the Loveboard-cover on the extruder. And push it all the way down. The cover must go behind the X-carriage-back.
  - ⚠ **Be careful not to pinch any cables.**
- Ensure that the two plastic covers fit together perfectly.

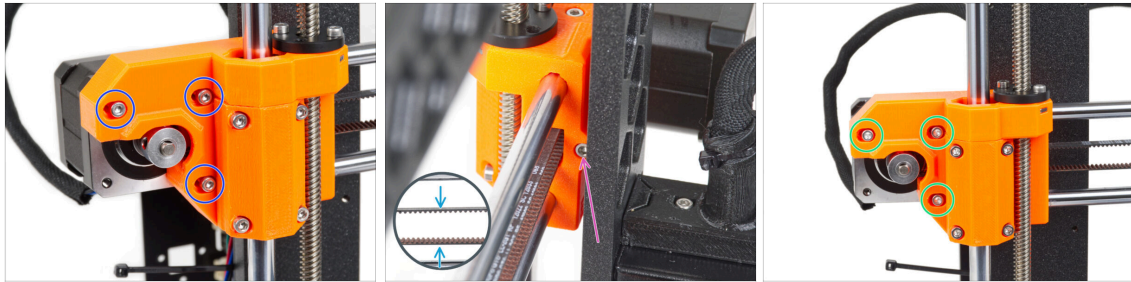
**STEP 43** Tensioning the X-axis belt

- i** In this step, we will finish tensioning the belt. Please read the instructions first, your belt might have proper tension already, then there is no need for additional screw adjustment.
- First, slightly release all the screws holding the motor, otherwise, the "tensioner" won't work (the motor must be able to move).
  - Using ball-end Allen key start tightening the screw on the rear side of the X-end-motor, but after each turn or two check the tension in the belt.
  - For optimal performance, the belt must have some resistance when pressed with your fingers. Move the extruder to the X-end-idler and try the belt tension in the middle of the X-axis.
  - When you achieve optimal tension, please tighten the screws again.



## STEP 44 Belt tension check



- i This step is recommended, but optional. If you don't have a phone at your disposal, continue to the next step. You can do this check later on.
- ◆ To verify or fine-tune the X or Y-axis belt tension on your printer, visit [prusa.io/belt-tuner](https://prusa.io/belt-tuner) and open up the webpage on your mobile device. Or using your phone, scan the QR code in the picture.
- ◆ Watch the instructional video on [prusa.io/belt-tuner-video](https://prusa.io/belt-tuner-video) and fine-tune your X belt tension, if required.
- i The belt tuner app was tested on multiple phones and should work across all most common phone manufacturers. However, in some rare cases it might not work as expected. Please state your brand and model in the comments below the step.

## STEP 45 Testing the X-axis belt

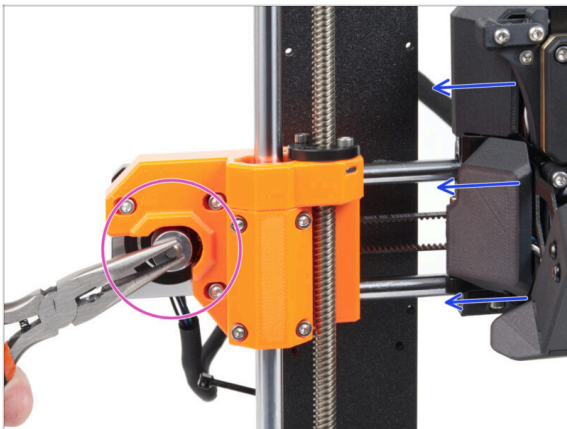

- ◆ Use the technique described below to test if the belt is properly stretched.
- ◆ Grasp and hold the flat part of the X motor shaft with pliers. This will prevent it from rotating in the pliers.
- ◆ Move the extruder towards the X motor. Don't use excessive force.
- ◆ If the belt is stretched properly, you should feel a resistance and the extruder won't move at all. If the belt is too loose, it will deform (create a "wave") and jump over the teeth on the pulley.

## STEP 46 Haribo time!

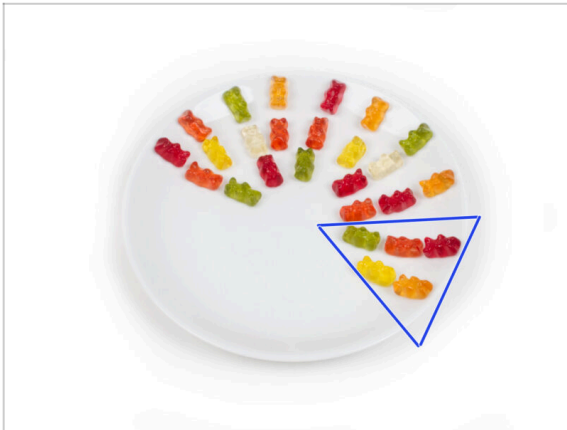

◆ Eat five gummy bears.

ⓘ **Did you know that** gummy bears have a long shelf life, typically lasting for up to two years if stored properly in a cool and dry place. But don't do that now.

## STEP 47 The extruder is assembled



- ◆ That was tough. But we made it!
- ◆ Let's go the next chapter: **6. xLCD assembly**

## 6. xLCD assembly

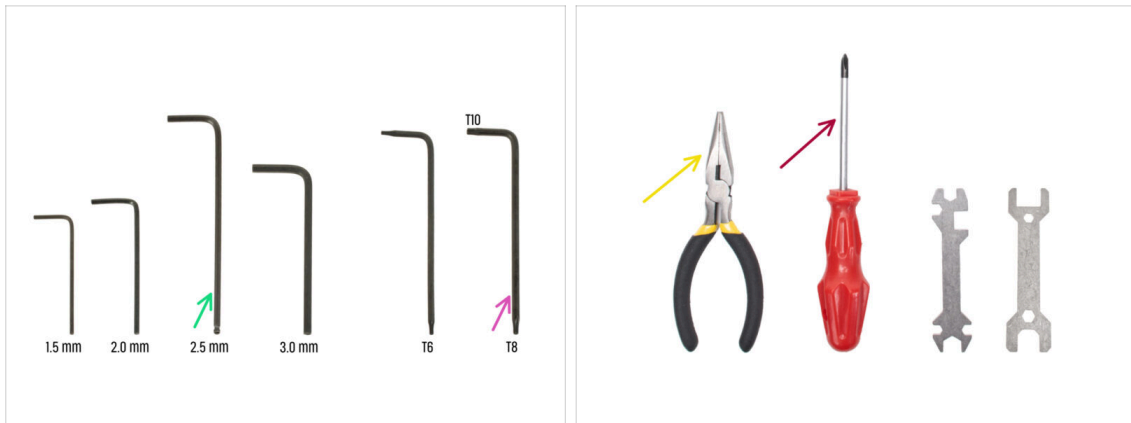

**STEP 1** Tools necessary for this chapter

● For the following steps, please prepare:

- 2.5mm Allen key
- Needle-nose pliers for tightening and cutting zip ties
- Torx key T8/10
- Phillips screwdriver

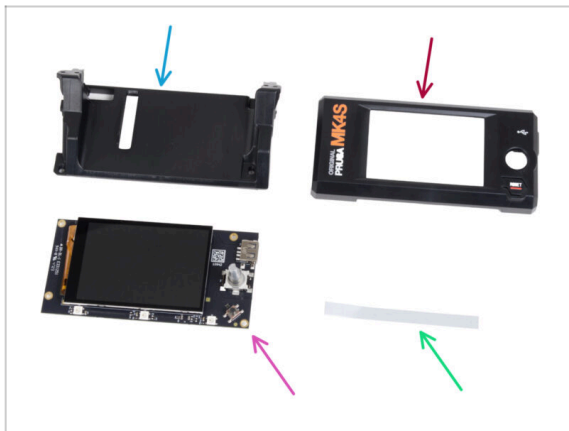
**STEP 2** xLCD assembly: parts preparation (part 1)

● For the following steps, please prepare:

- xLCD-support(1x)
- xLCDcover (1x)
- xLCD (1x)
- ⚠ Remove the protective film from the xLCD screen.
- xReflector sticker set (1x)
- ⓘ The list continues in the next step...

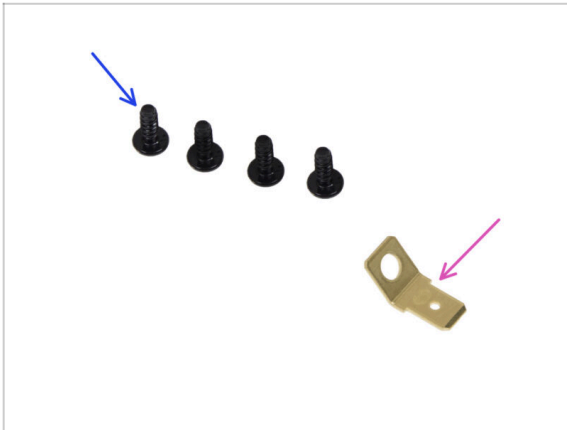
**STEP 3** xLCD assembly: parts preparation (part 2)

- ◆ 3x8sT screw (4x)
- ◆ PE Faston 6.3x0.8 (1x)

**STEP 4** Installing the xReflector sticker

- ◆ Peel off one of the individual adhesive xReflector sticker.
  - ◆ Note the separated part of the tape at one end. Do not peel off the remaining part.
- ⓘ If the sticker is damaged during peeling, there is an extra sticker in the SPARE package.
- ◆ Position the xReflector sticker strip so that it lines up with one side and both the edges of the "gutter" in the xLCD-cover. Continue to lay down the xReflector sticker strip towards the other side of the gutter.
- ◆ Press the xReflector sticker strip all the way into the gutter so it adheres to the xlcd-cover.

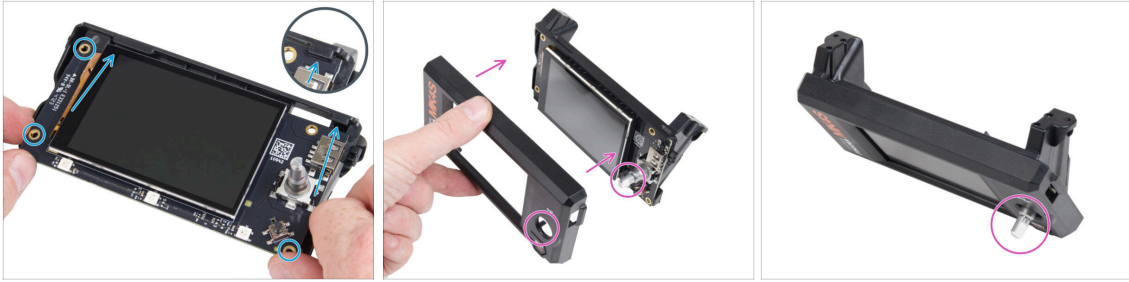
**STEP 5** Covering the xLCD

- ◆ Carefully slide the xLCD into the xLCD-support, ensuring it snaps under the plastic tabs. Align the screw holes in the xLCD board with the holes in the plastic part.
- ◆ Place the xLCD-cover on the xLCD, orienting it so the encoder passes through the hole in the cover.

**STEP 6** Installing the PE Faston

- ◆ From the back of the xLCD assembly, secure all parts together using three 3x8sT.
  - ⓘ The screws cut thread directly into the plastic, so there might be some resistance.
- ◆ Through the opening in the xLCD-support, place the PE Faston on the xLCD with the exact orientation as shown.
- ◆ Center the PE Faston in the opening and secure it with the 3x8sT screw.
  - ⓘ The screw cuts thread directly into the plastic, so there might be some resistance.

## STEP 7 xLCD cables: parts preparation

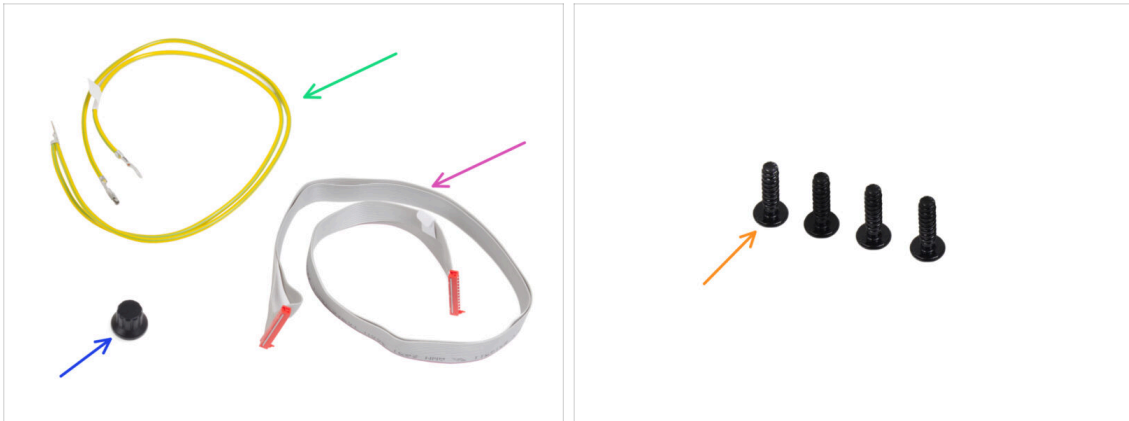

● For the following steps, please prepare:

- PE cable 460/420 mm (1x)
- xLCD cable (1x)
- xLCD-knob(1x)
- 3x12sT screw (4x)

## STEP 8 Connecting the xLCD cable & PE cable



- Take the xLCD cable and prepare the end without the QR code label.
  - ⓘ If your xLCD cable doesn't have a label, it won't affect functionality. The choice of cable end is purely for aesthetics.
- Connect the xLCD cable to the xLCD board. Ensure the **safety latch on the cable connector aligns with the triangle symbol** on the xLCD slot.
  - ⚠ **Make sure the xLCD cable is connected in the same orientation as seen in the picture. Otherwise, your display won't work**
- Take the end of the PE cable with the square connector. Slide the connector onto the PE Faston all the way.

**STEP 9** Attaching the knob

- Attach and push the xLCD-knob onto the xLCD encoder pin.
- ⓘ Note that there is a flat part on the encoder shaft. There is a geometry on the inside of the knob that should align with the flat part to seat the knob properly.

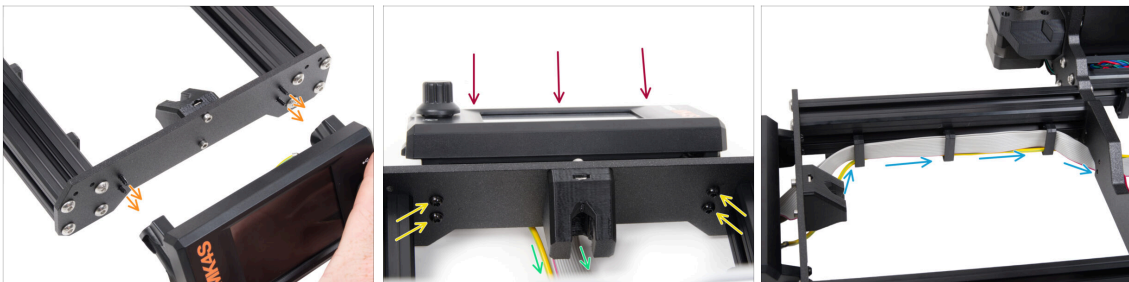
**STEP 10** Attaching the xLCD assembly

- There are four holes in the front plate of the printer's frame. Insert four 3x12sT screws through each of them from the inner side.
- Attach the xLCD assembly onto the front plate. The screws should fit into the corresponding openings in the xLCD assembly.
- Guide the xLCD and FE cables under the front plate to the frame.
- Tighten up all four 3x12sT screws.
- ⓘ The screw cuts thread directly into the plastic, so there might be some resistance.
- If screws are hard to tighten, pre-screw them into the xLCD support to create a thread for easier tightening.
- Guide both cables through the cable clips inside the frame, leaving the end of the xLCD cable free for now.

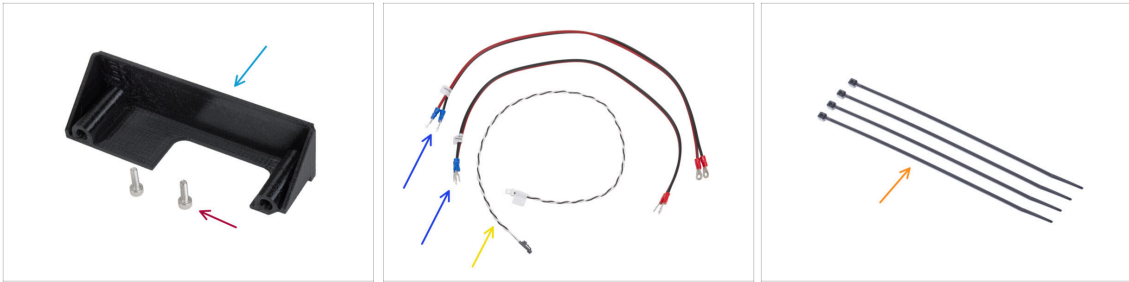

**STEP 11** Connecting the PSU: parts preparation

◆ **For the following steps, please prepare:**

- ◆ PSU-cover (1x)
- ◆ M3x10 screw (2x)
- ◆ xBuddy power cable (2x)
- ◆ Power panic cable (1x)
- ◆ Zip tie (4x)

**STEP 12** Connecting the PSU: PE cable

- ◆ Place the printer so that you have easy access to the bottom side of the PSU.
- ◆ Remove the left screw on the PSU circuit board. Note there is a washer on the screw. Do not throw the screw away, you will need it later.
- ◆ Place the single end of the PE (not the forked end) cable into the same place you have removed the screw. Secure the cable by re-using the screw together with the washer.
- ⚠ **Note the correct orientation of the PE cable connector.**
- ◆ Guide the PE cable so that it does not interfere with the threaded column under the PE connector.

## STEP 13 Power cables info

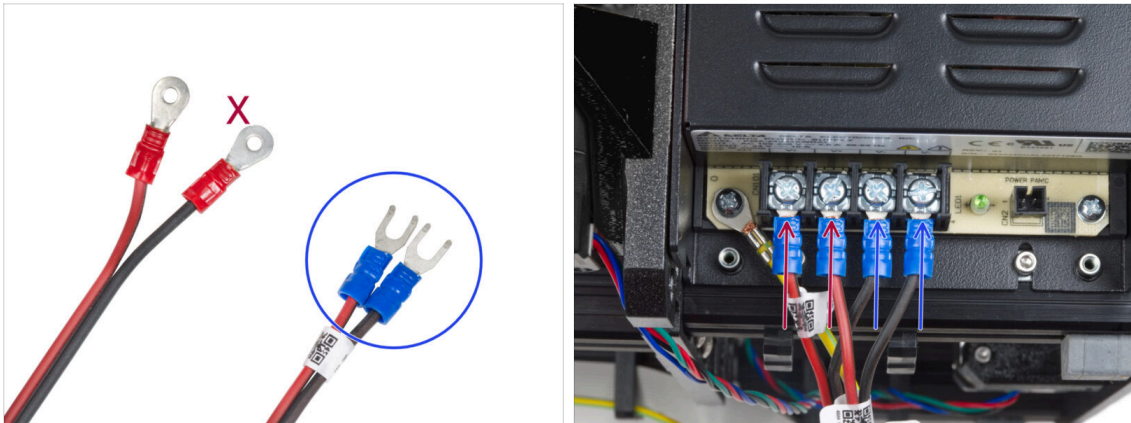

- i** In the following steps, we will be connecting the power cables one by one. The terminal screws are installed on the PSU already. Loosen them but **don't remove them completely** so they don't get mixed up with the other type of screws used on the xBuddy board side of the cable. Each of the two power cables has two leads. One has a prevailing **red color = positive / +**  
 One has a prevailing **black color = negative / -**
- ◆** Note that the power cables have different connectors on each end. For now, prepare the U-shaped connectors (crimping tube color may vary).
- ◆** **Note that the polarity of the terminals on the PSU is:**

  - ◆** Positive (V+)
  - ◆** Positive (V+)
  - ◆** Negative (V-)
  - ◆** Negative (V-)
- i** The red cable (positive) may have a black stripe on it. Similarly, the black cable (negative) can have a red stripe on it.
- ⚠** **Do not connect any cables yet, wait until you have prompted.**

**STEP 14** Connecting the PSU (part 1)

- ◆ Take two **RED** wires and slide the fork connectors all the way into the first two (positive) terminals from the left on the bottom of the PSU. Make sure the steel washer is above the "fork" connector.
- ◆ Point the bent part of the fork upwards.
- ◆ Tighten the terminal screws firmly.
- ⓘ Keep in mind some parts are made out of plastic. When tightening each of the terminal screws, proceed carefully.

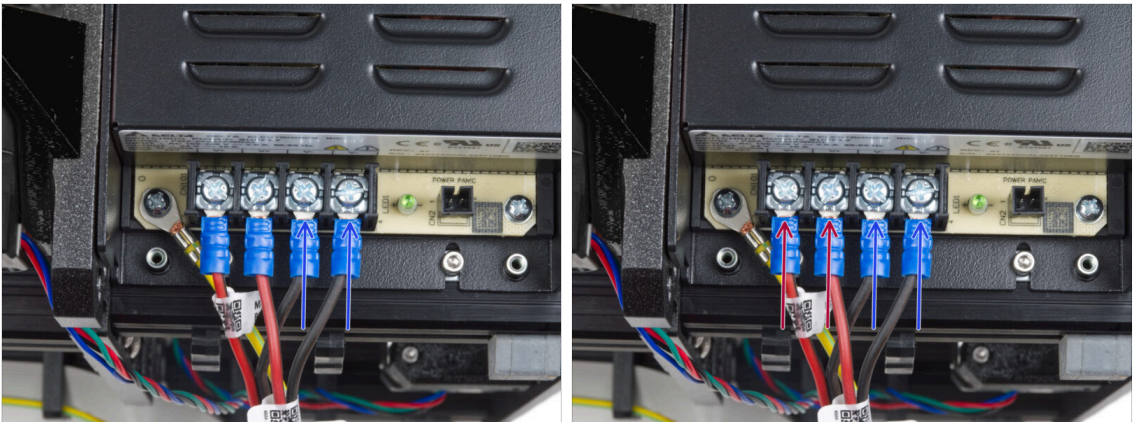
**STEP 15** Connecting the PSU (part 2)

- ◆ Take the **BLACK** wires and slide them all the way into the last two (negative) terminals. Make sure the steel washer is above the "fork" connector.
- ◆ Tighten the terminal screws firmly.
- ⚠ **Check all the connections again!**
- ◆ The red (+) wires are connected into the two terminals on the left.
- ◆ The black (-) wires are connected into the two terminals on the right.
- ⚠ **Make sure that cables are tightened properly. Otherwise, there is a risk of a damage to the printer and its surroundings!**

## STEP 16 Connecting the power panic

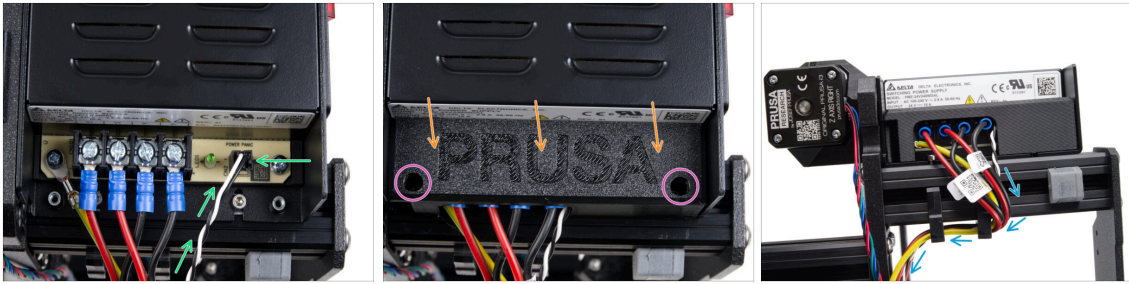

- ◆ Connect the power panic cable into the PSU. Use the side with the black connector at the end.
- ⚠ **Check all the connections again!** The red wire is in the second slot and black in the fourth. Make sure that all the cables are properly tightened. Otherwise, there is a risk of damage to the printer and its surroundings.
- ◆ Place the psu cover over the power terminals. Make sure the "PRUSA" logo is facing upwards.
- ◆ Attach the cover by using the two M3x10 screws through the marked openings. Note the openings are quite deep.
- ⚠ **Make sure the cover is seated properly and no cable is being pinched underneath.**
- ◆ Take a look from the bottom of the PSU and guide all the PSU cables through the cable clips according to the picture.

## STEP 17 Guiding the Z motor right cable



- ◆ Slide the zip tie through the circular holes in the frame to create a loop on both sides of the frame so that the cable goes through both the loops.
- ◆ Start tightening the zip tie so it is snug and holds the wires on both sides. Be careful not to over-tighten the zip tie as it could damage the wires. Cut off the remaining part of the zip tie very carefully.

## STEP 18 Guiding the power cable bundle

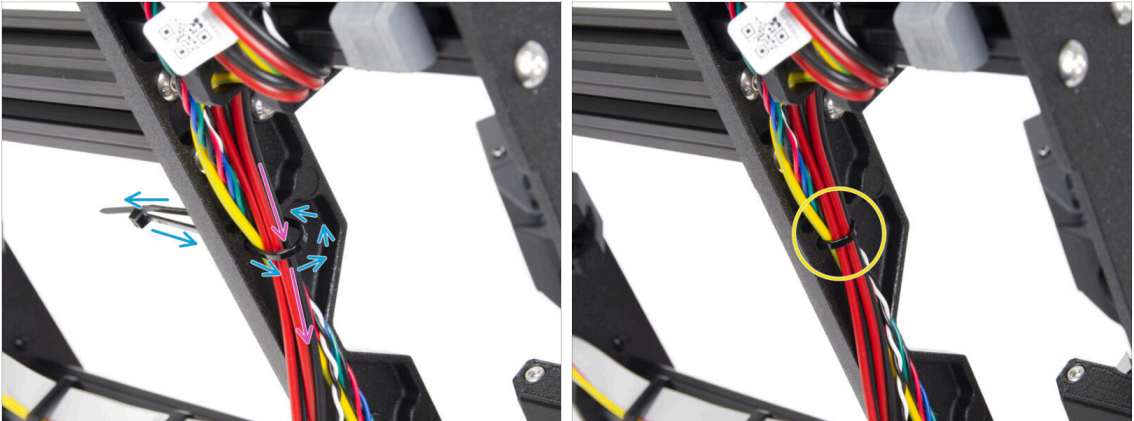

- ◆ Continue downwards and using another zip tie create the next loop.
- ◆ Guide the Z-axis cable and all cables from the PSU through the zip tie.
- ◆ Place the PE and power cables at the bottom of the bundle.
- ◆ Push the cable gently in the zip tie and tighten it so it is snug and holding the wires. Be careful not to over tighten the tie as it can cut the wires. Cut the remaining part.

## STEP 19 Guiding the power cables

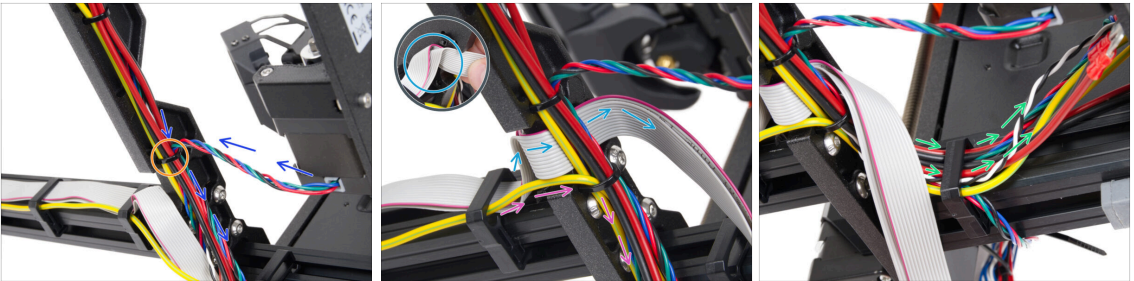

- ◆ Continue guiding the cables toward the xBuddy. Include the Y motor cable into the bundle.
- ◆ Secure it with another zip tie to the frame.
- ◆ Fold and carefully guide the xLCD cable under the cable bundle. **Do not include the xLCD cable in the cable bundle.** Leave it free for now.
- ◆ Guide the PE cable from the xLCD through the cutout in the frame and include it in the cable bundle.
- ◆ Secure the cable bundle with the zip tie.
- ◆ Guide all cables from the PSU through the cable-clip. Leave the ends of the cables free for now.

## STEP 20 Connecting the X and Y motor cables

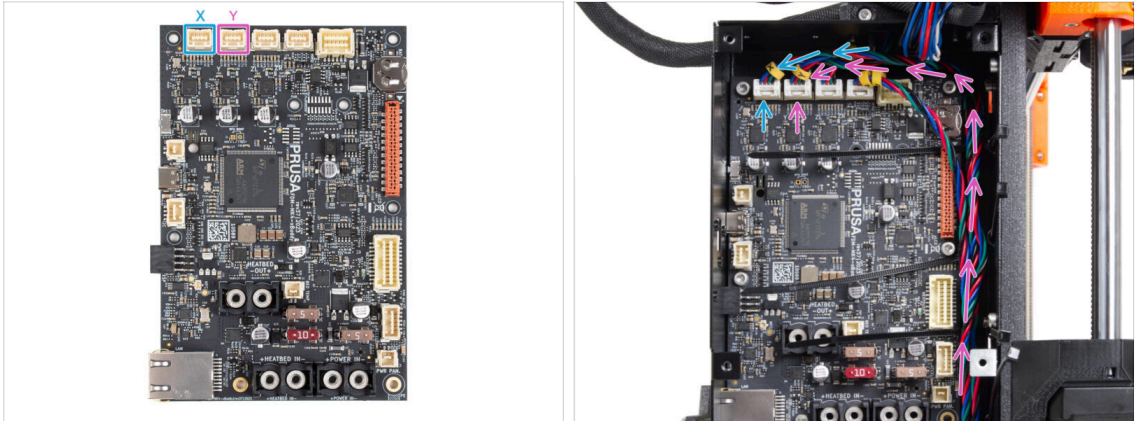

- ◆ Connect the X motor cable to the first slot from the left on the top of the xBuddy.
- ◆ Connect the Y motor cable to the second slot from the left on the top of the xBuddy. Guide the cable alongside the xBuddy box over the zip ties.

## STEP 21 Connecting the PSU cable: parts preparation

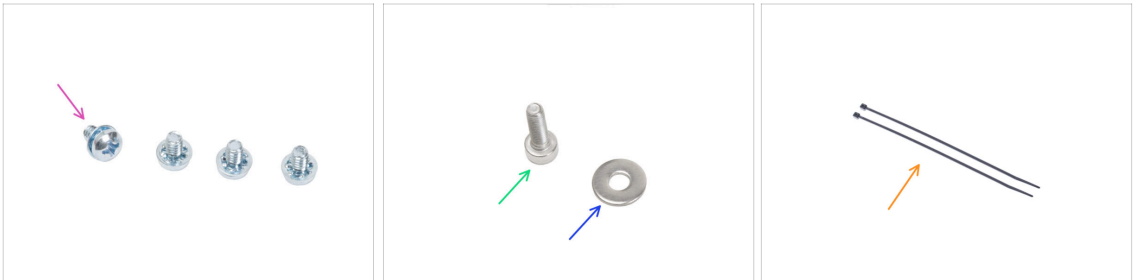

- ◆ **For the following steps, please prepare:**
- ◆ Power terminal screw 6/32" (4x)
- ◆ M3x6 screw (1x)
- ◆ M3w washer (1x)
- ◆ Zip tie (2x)

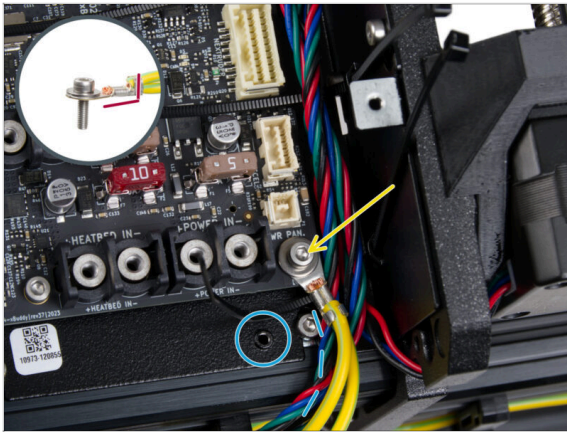
**STEP 22** Connecting the PSU cables: PE cable

- ◆ Attach the PE cable connector to the right lower screw hole in the xBuddy box. Secure the cable with the M3w washer and the M3x6 screw. Tighten the screw firmly.
- ⚠ Note the correct orientation of the PE connector.
- ◆ Guide the PE cable so that it does not interfere with the threaded hole under the xBuddy board.

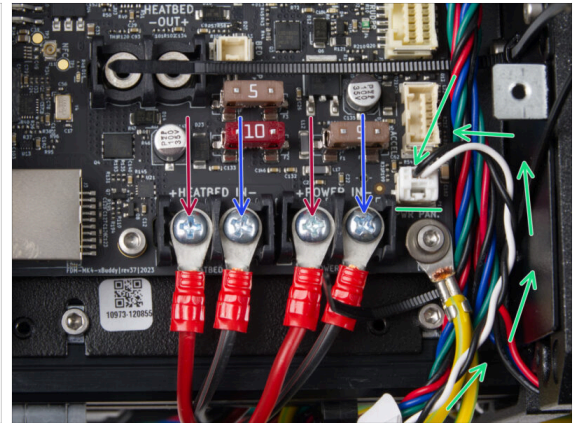
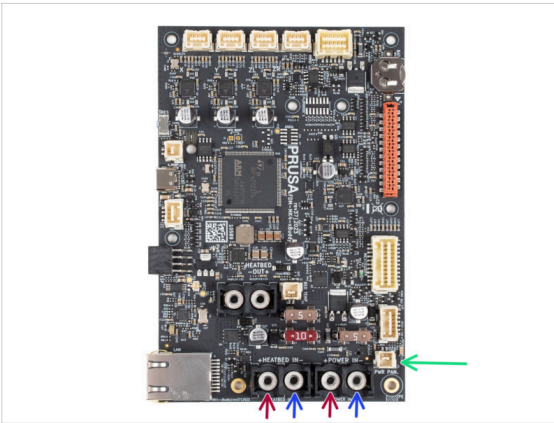
**STEP 23** Connecting the PSU cables:

- ◆ Connect the power panic cable to the white connector on the bottom of the xBuddy board.
- ◆ Connect the PSU cables into the xBuddy board in this order (starting from the left with the first pair of the PSU cables). :
  - ◆ Red power cable (positive)
  - ◆ Black power cable (negative)
  - ◆ Red power cable (positive)
  - ◆ Black power cable (negative)
- ◆ Secure all power cable connectors with the terminal screws. Tighten the screws firmly.
- ⚠ **Verify the correct placement of the cables comparing it to the picture. This is crucial! Incorrect wiring may cause damage to your printer!**

## STEP 24 Securing the PSU cables

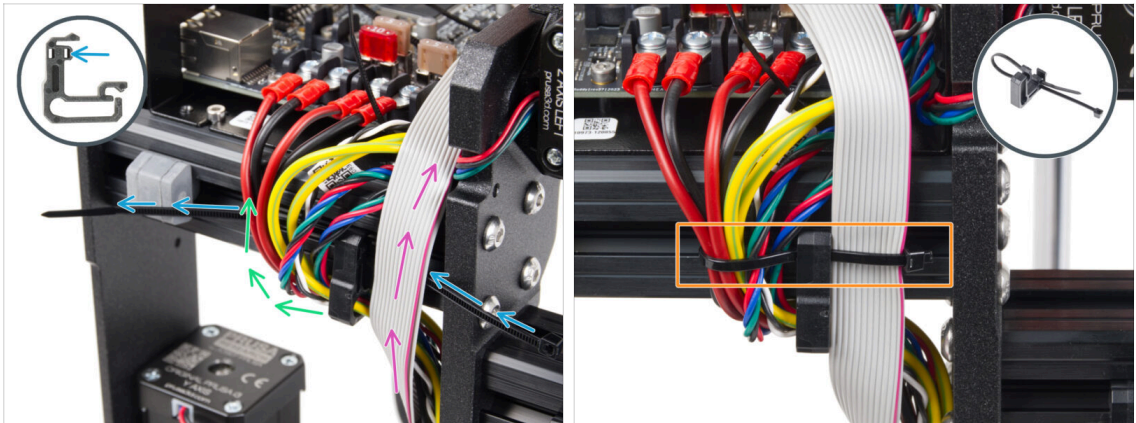

- ◆ **Divide the cable bundle into two paths:**
- ◆ Insert the zip tie through the right hole in the cable clip.
- ⓘ See the detail showing an example how to guide a zip tie through the cable clip.
- ◆ Guide the cables from the PE cables, PSU cables, Power Panic cable and motors cables around the left side of the cable clip.
- ◆ Guide the xLCD cable around the right side of the cable clip.
- ◆ **Very gently** tighten the cables with the zip tie. Cut off the remaining zip tie.

## STEP 25 Guiding the Z motor left cable

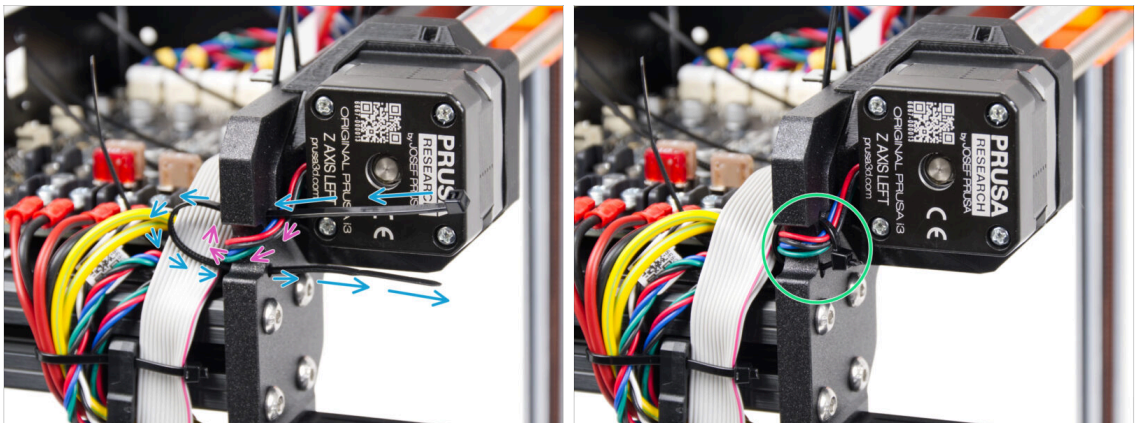

- ◆ Push the zip tie through the frame under the Z motor left.
- ◆ Guide the Z motor left cable through the cutout in the frame to the xBuddy box.
- ◆ Carefully tighten the zip tie. Cut off the excess of the zip tie.
- ⚠ **Do not overtighten the zip tie, it may fatally damage the cable.**



## STEP 26 Connecting the xLCD cables

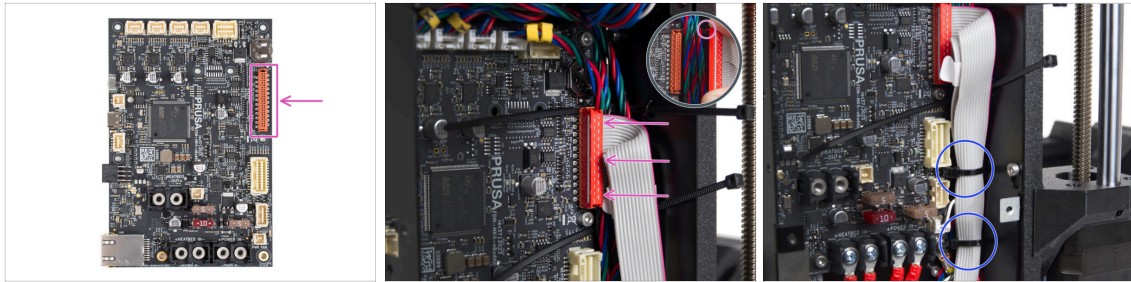

- ◆ Connect the xLCD to the slot on the right side of the xBuddy. Note the safety latch on the xLCD cable connector. The latch must fit into the upper side of the connector.
- ⚠ **Make sure all the cables guide through the zip ties in the xBuddy box, not under them.**
- ◆ Arrange the xLCD cable like in the picture. The xLCD must covering the cable bundle. Tighten the cable bundle with the first two zip ties in the bottom of the xBuddy box. **Do not overtighten the zip ties!**

## STEP 27 Connecting the extruder main cable

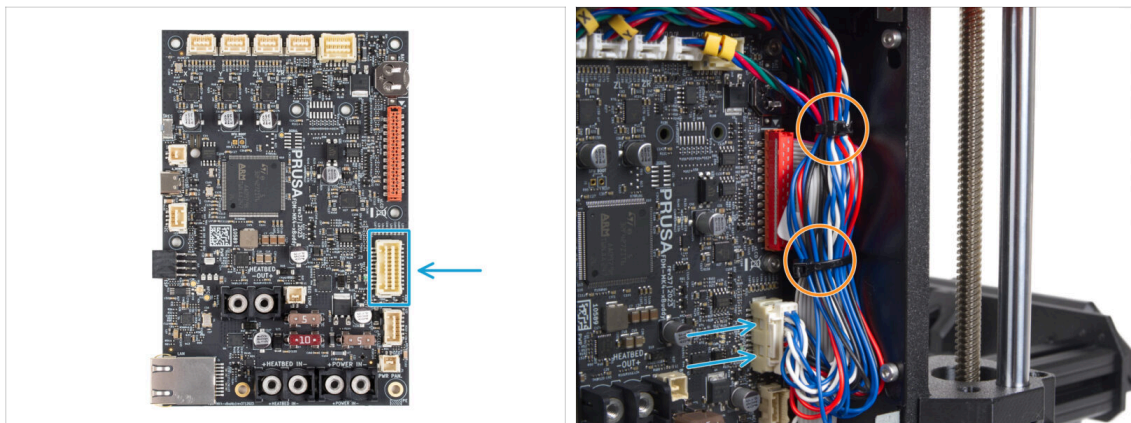

- ◆ Connect the extruder main cable to the slot in the right side of the xBuddy.
- ◆ Arrange the cable according to the picture. Tighten the cable bundle (extruder main cable and the motor cables) with the two upper zip ties. **Do not overtighten the zip ties!**

## STEP 28 Time for energy delivery!



- ◆ It was almost like rocket science, but you did it! Take six gummy bears.
- ⓘ **Did you know that** some gummy bear manufacturers offer sugar-free versions of the candy, which are sweetened with artificial sweeteners like maltitol or stevia.

## STEP 29 Almost there!



- ◆ Wasn't as hard, right? You are almost there!
- ◆ Just compare the xLCD assembly and the cable management to the pictures.
- ◆ Let's go the next chapter: **7. Y-carriage & Heatbed assembly**

## 7. Y-carriage & Heatbed assembly

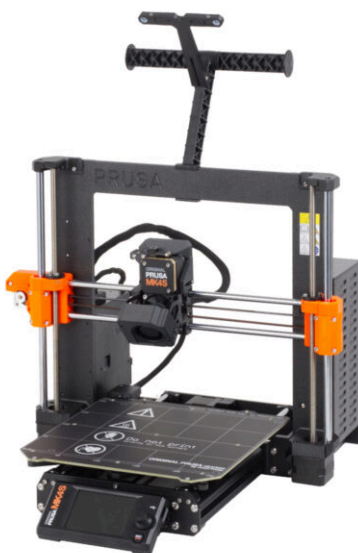

## STEP 1 Tools necessary for this chapter

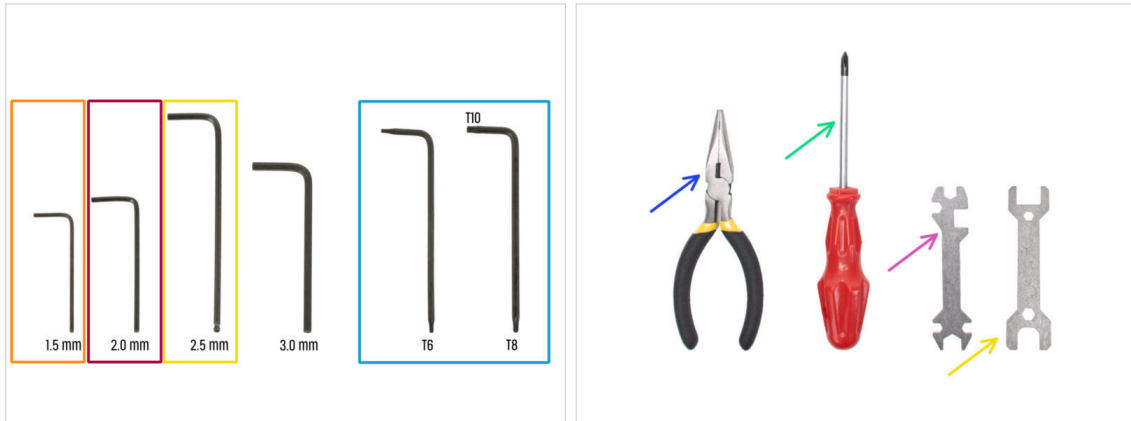

● **For this chapter, please prepare:**

- 1.5mm Allen key
- 2.0 mm Allen key
- 2.5mm Allen key
- Torx T8/10 key
- Needle-nose pliers
- Phillips screwdriver PH2
- Universal wrench

## STEP 2 Heatbed cable assembly: parts preparation

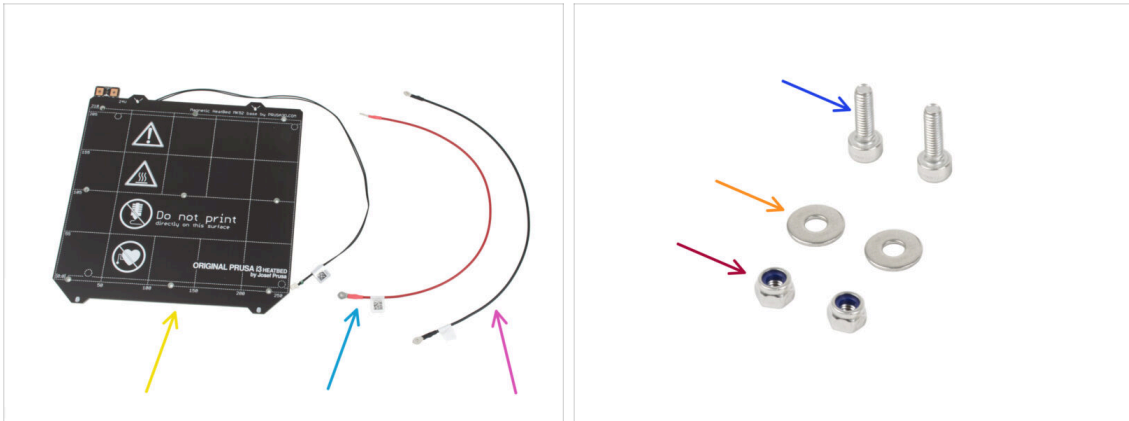

● For the following step please prepare:

- Heatbed MK52 24V (1x)
- Heatbed cable red (1x)
- Heatbed cable black (1x)
- M3x10 screw (2x)
- M3w washer (2x)
- M3nN nut (2x)

## STEP 3 Heatbed cable assembly (part 1)

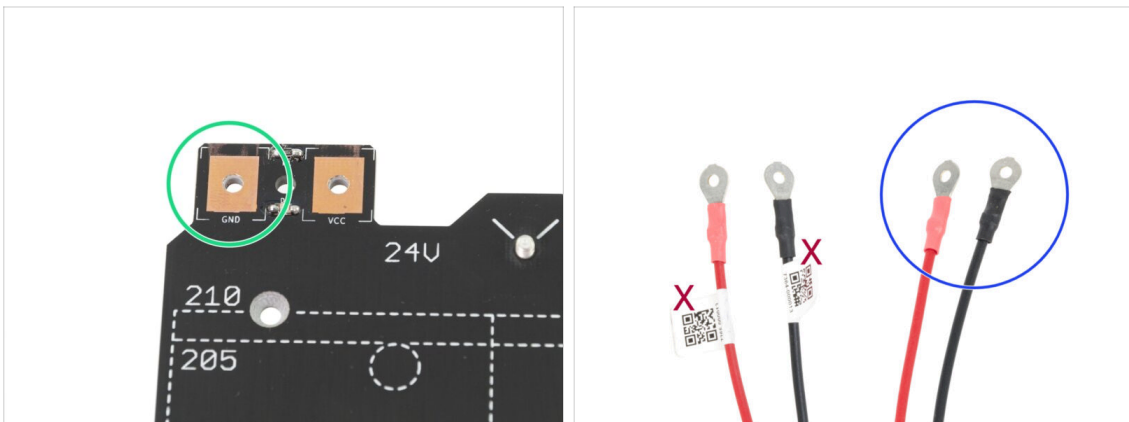

- **IT IS IMPORTANT** to connect the power cable correctly. Before you start the assembly have a look at the pins. The one on the left with "GND" sign must be connected to the **BLACK WIRE**.
- Take both Heatbed cables. Note the label on each cable. For the following steps, prepare the ends of the cables **without the label**.

## STEP 4 Heatbed cable assembly (part 2)

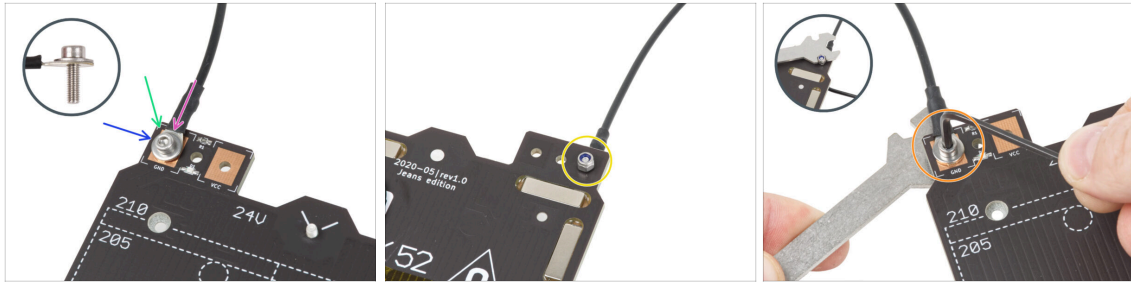

- ◆ Place the black wire above the pin with "GND" sign. **Use the end of the cable that is not labeled with QR code.** The QR code must be at the other end.
- ◆ Place the M3w washer above the round cable connector.
- ◆ Press the M3x10 screw through all parts.
- ◆ Hold the screw and carefully turn the heatbed upside down.
- ◆ Attach the M3nN nut onto the M3x10 screw and tighten it slightly.
- ◆ Turn the heatbed back around. Using the universal wrench and the Allen key, tighten up the screw. We will adjust the cable position later on, **therefore do not tighten the screw too firmly yet.**

## STEP 5 Heatbed cable assembly (part 3)

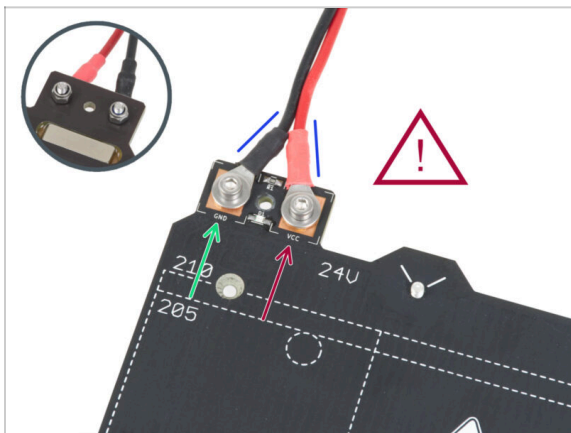

- ◆ Repeat this procedure for the second (Red / + / VCC) wire. **Use the end of the cable that is not labeled with QR code.** The QR code must be at the other end.
- ⚠ **Before proceeding further, please check again that:**
  - ◆ **BLACK** wire must be connected to the "GND"
  - ◆ **RED** wire must be connected to the "VCC"
- ◆ The cable cover, which will be applied later requires the connectors to be slightly inclined towards each other. Press them gently, but leave a gap between them.
- ⚠ **Now, tighten both screws firmly using the Allen key and the wrench. Maintain the position of the connectors while tightening.**

## STEP 6 Covering the heatbed cables: parts preparation

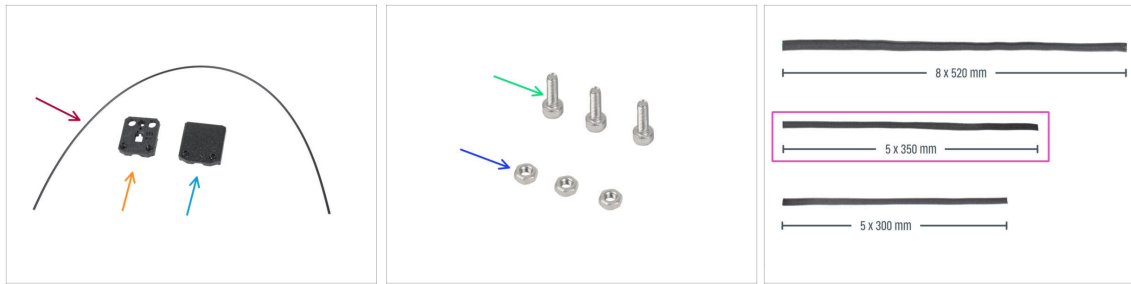

◆ For the following steps, please prepare:

- ◆ Nylon 2x380 mm (1x)
- ◆ heatbed-cable-cover-bottom
- ◆ heatbed-cable-cover-top
- ◆ M3x10 screw (3x)
- ◆ M3n nut (3x)
- ◆ Textile sleeve 5x350 (1x)

## STEP 7 Assembling the heatbed-cable-cover-bottom

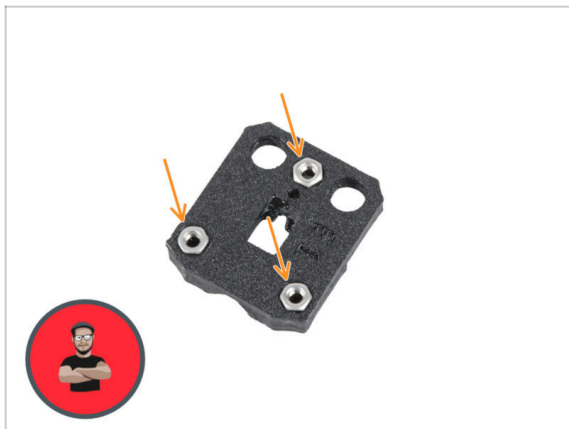

- ◆ Insert three M3n nuts into the shaped openings in the heatbed-cable-cover-bottom.
- ⓘ Use the screw pulling technique.

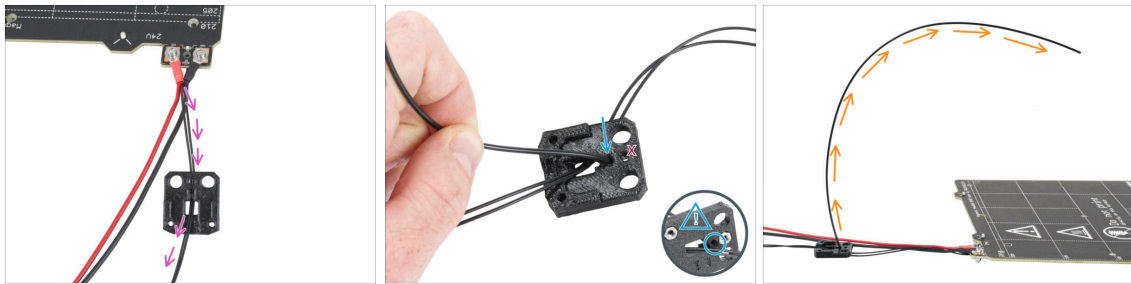
**STEP 8** Assembling the heatbed-cable-cover: nylon filament

- ◆ Place the heatbed-cable-cover-bottom like in the picture. Push the heatbed thermistor cable through the heatbed-cable-cover-bottom.
- ◆ Insert the nylon filament into the hole in the heatbed-cable-cover-bottom. Don't let the nylon filament stick out too much on the other side. It should not protrude more than 2 millimeters.
- ⚠ **When inserting the nylon filament, ensure that the filament does not damage the thermistor cables under the printed part.**
- ◆ Orient the curve of the filament as shown in the third picture.

**STEP 9** Assembling the heatbed-cable-cover-bottom

- ◆ Slide the cable-cover-bottom under the heatbed cable connectors (M3nN nuts). See the correct orientation in the picture.
- ◆ Secure the cover with the M3x10 screw from the top. Tighten the screw firmly.
- ⚠ **Make sure the nylon filament is still bent upward as in the previous step.**



## STEP 10 Assembling the heatbed-cable-cover-top

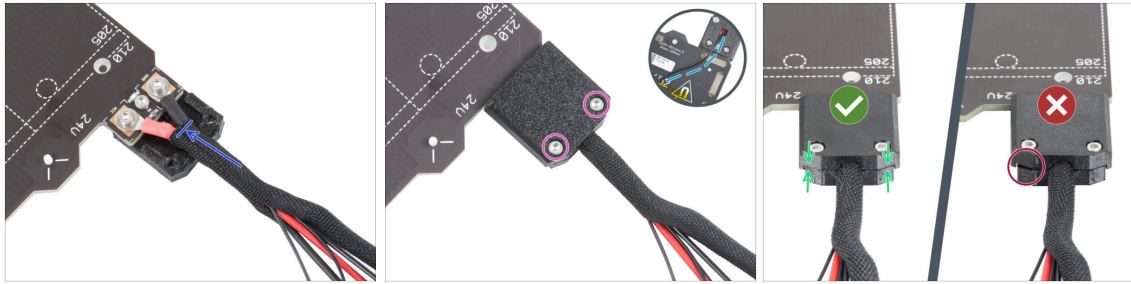

- Wrap the end of the cable bundle together with the nylon filament in the textile sleeve. Slide the sleeve as far towards the heatbed as possible.
- Attach the heatbed-cable-cover-top onto the junction and secure it with two M3x10 screws.
- On the bottom side, leave a slack on the thermistor cable for one finger to be pushed through.
- Make sure there is no big gap between both covers.

## STEP 11 Wrapping the textile sleeve

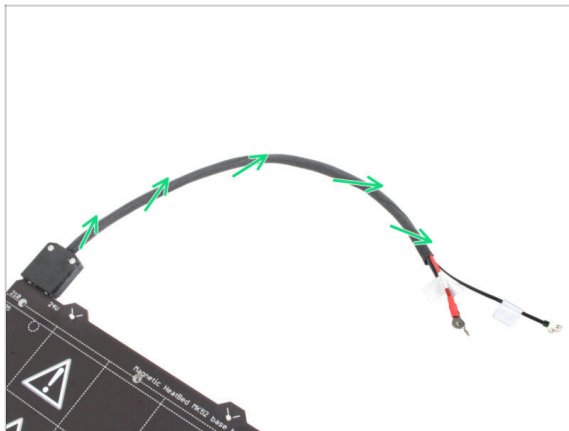

- Finish wrapping the cable bundle in the textile sleeve. And twist the sleeve, **not the cables**.

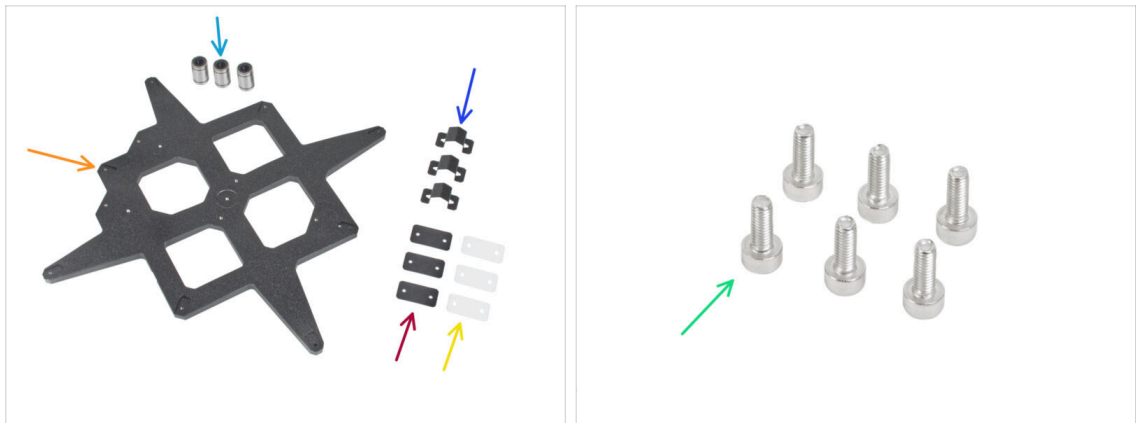
**STEP 12** Y-carriage: parts preparation

● For the following steps, please prepare:

- LM8UU bearing (3x)
- The bearings come pre-lubricated from our factory and do not require additional lubrication upon initial use.
- Y-carriage (1x)
- Bearing clip (3x)
- Rubber bearing pad 31x16x1 mm (3x)
- Plastic bearing pad 31x16x0.5 mm (3x)
- M3x8 screw (6x)

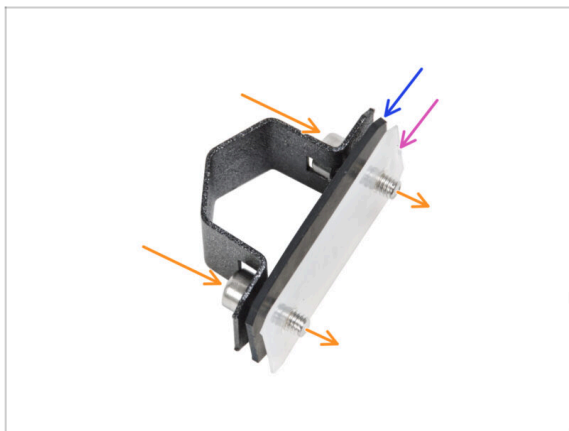
**STEP 13** Assembling the bearing clips

- Push two M3x8 screws through the bearing clip.
- Insert the rubber bearing pad on the screws.
- Insert the plastic bearing pad on the screws.
- Repeat the same for the remaining two bearing clips.

⚠ **The order of the pads is crucial.**  
Check the order on all three bearing clips.

## STEP 14 Installing the bearing on the Y-carriage

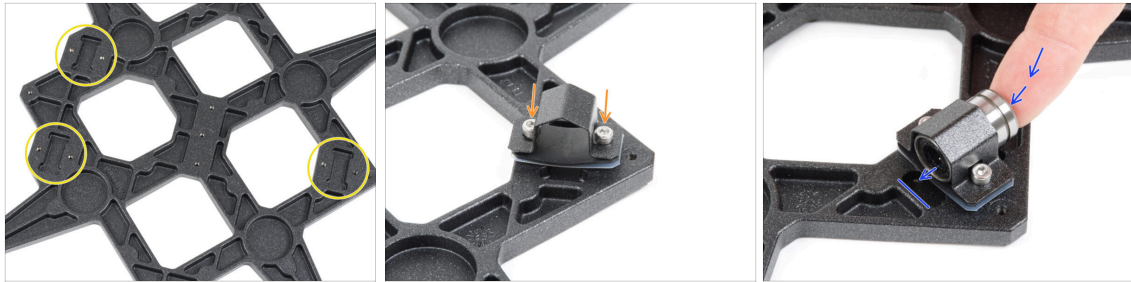

- ◆ Note the three pockets for bearings in the Y-carriage.
- ◆ Start with the side with the one pocket. Attach the bearing clip on the cutout.
- ◆ Insert the bearing into the bearing clip.

## STEP 15 Aligning the bearing

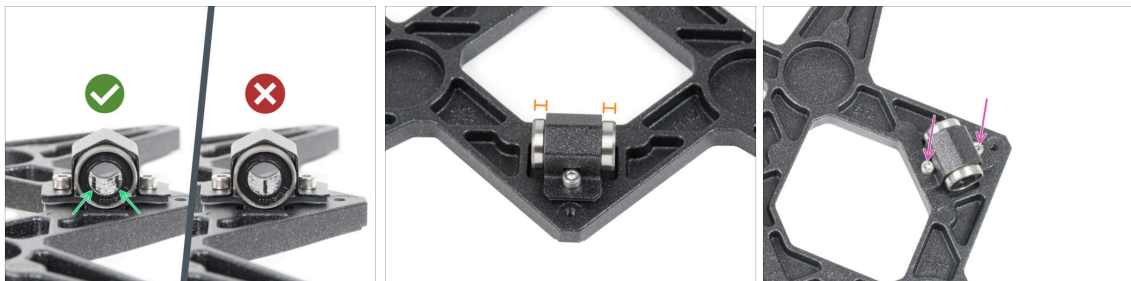

- ◆ **The correct bearing orientation:** When placing bearings onto the Y-carriage, **make sure that they are oriented as shown in the picture.** The tracks (rows of balls) have to be in the corners.
- ◆ Align the bearing so that it is centered in the bearing clip. Approximately the same amount of bearing should be visible on each side.
- ◆ Maintain the bearing position and slightly tighten both screws. Just enough to maintain the bearing's position and orientation. You will tighten the screws firmly later on.

**STEP 16** Installing the bearings on the Y-carriage

- ◆ Attach two bearing clips on the remaining two bearing pockets and push two bearings inside.
- ◆ Orient both bearings so that the two rows of bearing balls have to be on the sides.

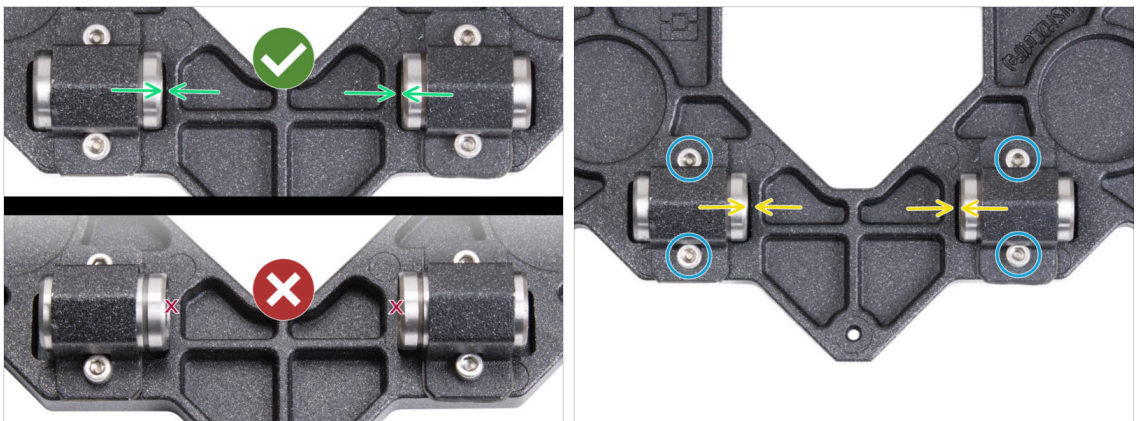
**STEP 17** Positioning of the bearings

- ⚠ **Correct bearing alignment is CRUCIAL.** Proceed carefully and make sure that **both bearings are as close to the center of the Y-carriage as possible and do not touch any pocket edge.**
- ◆ Unlike the previous single-bearing, position the bearings as close to the center of the Y-carriage as possible. **Beware, the bearings must not touch the edge of the pocket!**
- ⚠ **Incorrect positioning: the bearings must not touch or overlap the edges of the pocket as shown in the bottom of the first picture.**
- ◆ **Maintain the bearing's position** and slightly tighten the screws. Just barely to maintain the position and orientation of the bearings. We will tighten the screws firmly later on.
- ◆ After securing the clips double-check the correct position of the bearings so that they do not touch the edges of the pockets.

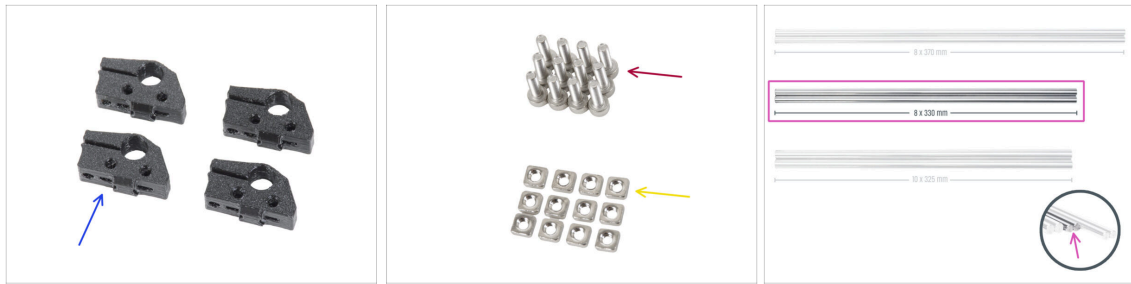
**STEP 18** Y-axis: smooth rods holders

◆ For the following steps, please prepare:

- ◆ Y-rod-holder (4x)
- ◆ M3x10 screw (12x)
- ◆ M3nS nut (12x)
- ◆ Smooth rod 8x330 (2x)

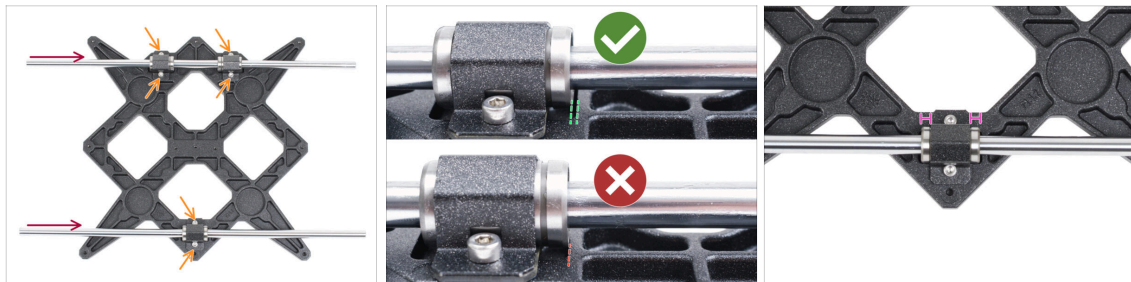
**STEP 19** Inserting smooth rods into Y-carriage

◆ Using a paper towel, wipe the transport oil from the surface of the smooth rods.

- ⚠ **NOW, PLEASE BE VERY CAREFUL!** Gently insert the rod straight into the bearings, do not apply too much force and do not tilt the rod!
- ⓘ In case you manage to push out some balls from the bearings by accident, please count the balls. Without one or two balls, the bearing will continue to work. If there are more of them, please consider ordering new bearings.
- ◆ Tighten the screws on each bearing clip.
- ⚠ After the final tightening, the **movement of the smooth rods must be gentle**. If the smooth rod moves stiffly, loosen the screws and repeat the procedure.
- ◆ After tightening all the screws securing the bearing clips, make a **final check of the correct position of the bearings**:
  - ⚠ **Two-bearing side:** the bearing must be positioned closer to the center of the Y-carriage. It must not touch or extend over the edge of the pocket.
  - ◆ **Single-bearing side:** the bearing must be in the center of the pocket.

**STEP 20** Preparing Y-rod-holder

- ◆ Take one Y-rod-holder and insert two M3nS nuts.
- ◆ Make sure you've pressed the nuts all the way in. You can use pliers, **BUT** be careful, you can damage the printed part.
- ⓘ In case you can't press the nuts in, don't use excessive force. First, check if there isn't any obstacle in the nut trap.
- ◆ Insert one M3nS nut from the side of the Y-rod-holder.
- ◆ Ensure and adjust the alignment of each nut with the 2mm Allen key.
- ◆ Repeat for the remaining Y-rod-holders.

**STEP 21** Mounting the Y-rod-holder parts

- ◆ Push one of the Y-rod-holders onto the rod. Align the front surface of the plastic part with the flat surface of the rod.
- ◆ Check the correct position of the Y-rod-holders. The screw hole must be facing up and towards the center of the Y-carriage (see the picture).
- ◆ Repeat for the remaining Y-rod-holders.

**STEP 22** Installing the Y-carriage

- Take the Y-carriage including smooth rods with rod holders and place them in YZ-frame. Make sure, that **two bearings are on the left side** (see the picture, there are two pairs of the screw holes on the left and one pair on the right).
- Secure each Y-rod-holders and fix them with M3x10 screws on the front plate (the one with the longer extrusions). Tighten both screws equally, but not completely. We will tighten them fully later on.
- Insert the M3x10 screw into the hole in each front holder and tighten them.
- Secure the second pair of the Y-rod-holder with two M3x10 screws. Tighten both screws equally, but not completely. We will tighten them fully later on.
- Insert the M3x10 screw into the hole in each rear holder and tighten it.
- ⓘ In case the M3nS nuts keep falling out, please flip the frame upside down. Tighten both printed parts and then return the frame to the original position.

**STEP 23** Aligning the smooth rods

- ⚠ **IMPORTANT:** proper alignment of the smooth rods is crucial to reduce noise and overall friction.
- Move the Y-carriage back and forth across the entire length of the smooth rods to align them.
- Then move the carriage to the front plate and tighten all screws in the front-Y-holders.
- Move the Y-carriage to the rear plate and tighten all screws in the back-Y-holders.

## STEP 24 Assembling the Y belt: parts preparation



◆ For the following steps, please prepare:

⚠ **The printed parts are not the same, take a closer look and compare both parts with each other.**

- ◆ Y-belt-tensioner (1x) with an oval hole
- ◆ Y-belt-holder (1x) with a hexagonal hole
- ◆ M3x40 screw (1x)
- ◆ M3x10 screw (4x)
- ◆ M3nN nut (1x)
- ◆ GT2-20 pulley (1x)
- ◆ Pin H8 2.9x20 (1x)
- ◆ Y belt (1x)

## STEP 25 Assembling the Y-belt-holder



◆ Insert the M3nN nut **all the way into the Y-belt-holder.**

- ⓘ Use the screw pulling technique. Attach the M3nN nut on the tip of the M3x40 screw (a few turns are enough). **Do not tighten the screw**, pull the nut all the way into the Y-belt-holder. Don't forget to remove the M3x40 screw from the part and keep it aside for later use.



**STEP 26** Assembling the Y belt

- ◆ Lean the printer onto the right side (the one with the PSU) to gain access to the bottom.
- ◆ Insert the M3x10 screw through the hole in the Y-belt-holder.
- ◆ Take one of the Y belt ends and push it into the Y-belt-holder. Note the orientation of the belt (teeth).
- ◆ Secure it by inserting and tightening the M3x10 screw.

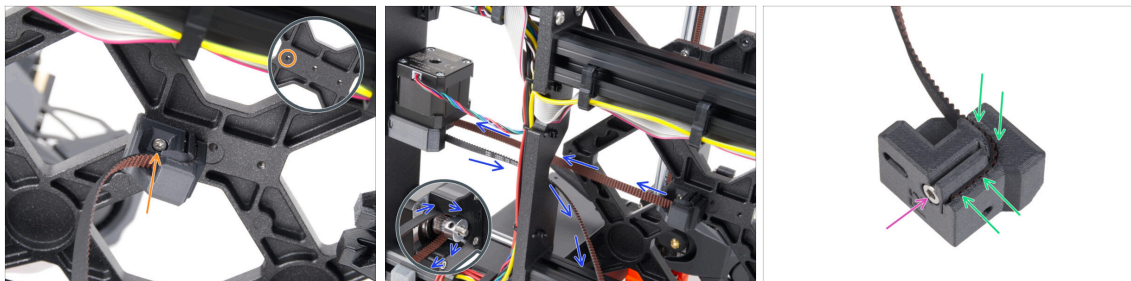
**STEP 27** Attaching the Y belt holder

- ◆ Using the M3x10 screw, fix the Y-belt-holder to the Y-carriage. Use the left (rear) hole in the center part.
- ⓘ Tip: pre-screw the screw into the Y-belt-holder before attaching it to the Y-carriage.
- ◆ Guide the Y-axis belt around the Y-axis motor pulley. Make sure the belt is inside the frame, not under!
- ◆ Take the free end of the Y belt guiding from the pulley and push it into the groove in the Y-belt-tensioner.
- ◆ Secure it with the M3x10 screw.

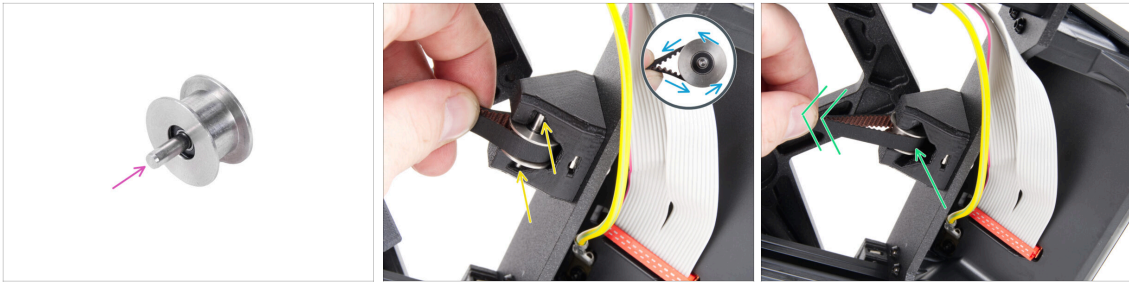
**STEP 28** Assembling the Y belt tensioner

- ◆ Push the pin into the pulley and center it.
- ◆ Take the Y-belt-tensioner with the belt and guide the belt around the GT2-20 pulley.
- ◆ Insert the belt with the pulley into the Y-belt-idler on the rear of the front plate.
- ◆ Push the pulley all the way inside the printed part and lightly pull on the belt to lock the pulley in place.

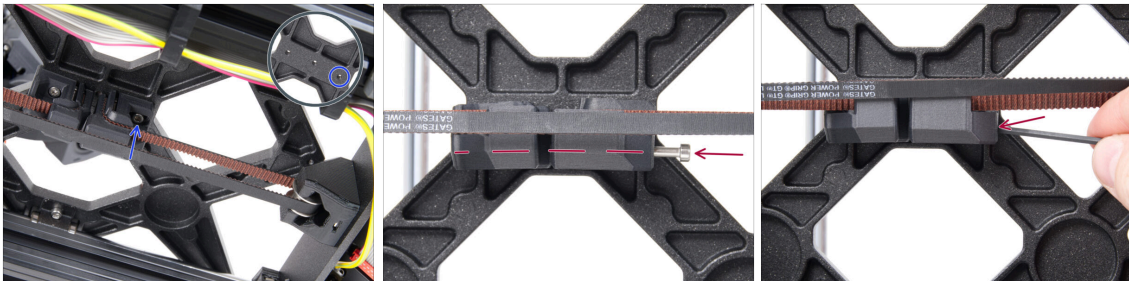
**STEP 29** Attaching the Y belt tensioner

- ◆ Insert the M3x10 screw into the Y-belt-tensioner and attach the Y-belt-tensioner to the right (front) hole in the Y-carriage and secure it with the M3x10 screw. **Do not overtighten the screw.** We will adjust the exact position later on.
- ⓘ If the screw does not reach the hole in the Y-carriage, it is necessary to remove the Y-belt-holder (the one already installed) and reposition the belt by one tooth in both printed parts - one tooth in each printed part will be vacant.
- ◆ Insert the M3x40 screw into the Y-belt-tensioner and tighten it until the screw reaches the nut in the second part.

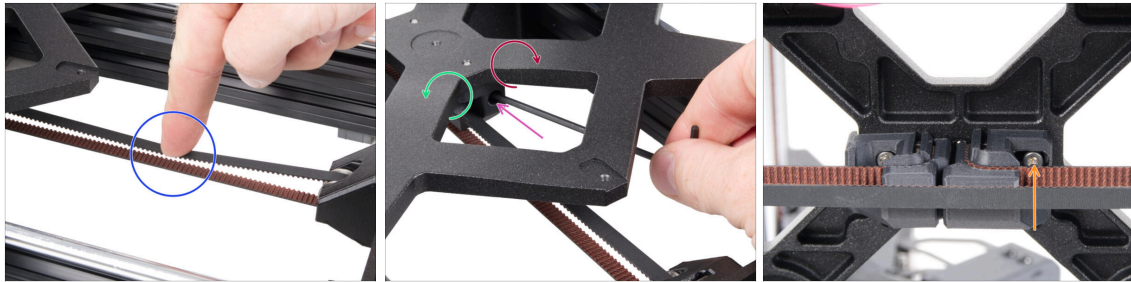
**STEP 30** Tensioning the Y belt

- ◆ Move the Y-carriage all the way to the back. Using a finger on your left hand, push the belt down. A medium force should be needed to squish the belt until both the parts touch. Don't try to overstretch the belt as you might damage the printer.
- ◆ You can change the belt tension by adjusting the long M3x40 screw on the bottom of the Y-carriage.
  - ◆ **Tighten the screw** to bring the parts closer together and **increase the tension**.
  - ◆ **Release the screw** to move the parts apart to **decrease the tension**.
- ◆ After you set the correct belt tension, tighten up the M3x10 screw on the bottom to fix the Y-belt-tensioner in place.

**STEP 31** Belt tension check

- i This step is recommended, but optional. If you don't have a phone at your disposal, continue to the next step. You can do this check later on.
- ◆ To verify or fine-tune the X or Y-axis belt tension on your printer, visit [prusa.io/belt-tuner](https://prusa.io/belt-tuner) and open up the webpage on your mobile device. Or using your phone, scan the QR code in the picture.
- ◆ Watch the instructional video on [prusa.io/belt-tuner-video](https://prusa.io/belt-tuner-video) and fine-tune your Y belt tension, if required.
- i The belt tuner app was tested on multiple phones and should work across all most common phone manufacturers. However, in some rare cases it might not work as expected. Please state your brand and model in the comments below the step.

### STEP 32 Aligning the Y belt

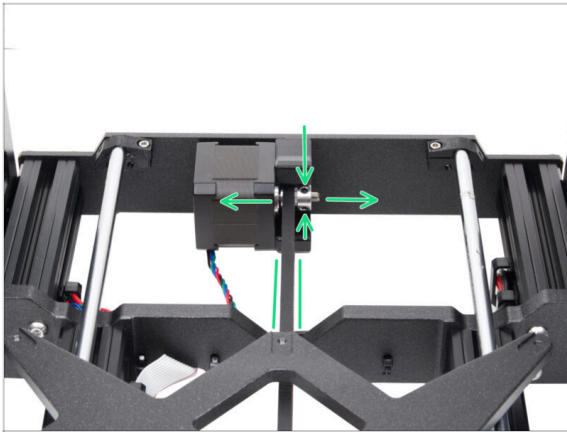

- Make sure that both the top and bottom parts of the belt are parallel (directly above each other).
- If not, adjust the belt position. Release both screws on the pulley and slightly move with it, until you reach the best position.
- Tighten both screws on the pulley.

### STEP 33 Installing the Expansion joints: parts preparation



- For the following steps, please prepare:
- Expansion joint (8x)
- M3x6r screw (8x)

## STEP 34 Preparing the expansion joints



- Install eight M3x6r screws in the outer holes on the Y-carriage. **Do not tighten them completely.** A few turns are enough for now.

## STEP 35 Installing the Expansion joints

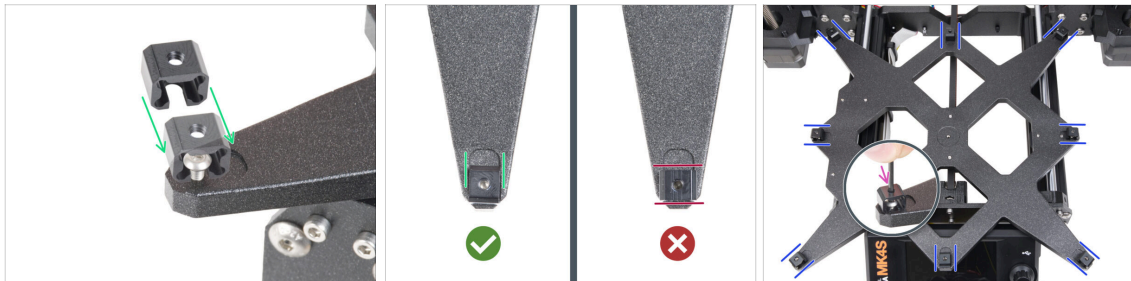

**⚠ The installation of the expansion joints needs to be done carefully.** It is crucial for the correct functionality of the printer. Carefully read the instructions:

- Slide the expansion joint from the side on the M3x6r screw.
- ⚠ Make sure the expansion joints are correctly oriented.** There is a recess with approximately the same shape as the expansion joint. The joint must fit into the recess. **See the second picture.**
- Maintain the position and tighten the M3x6r screw using the 2.0mm Allen key.
- Proceed the same for the rest of the expansion joints.

## STEP 36 Attaching the heatbed: parts preparation

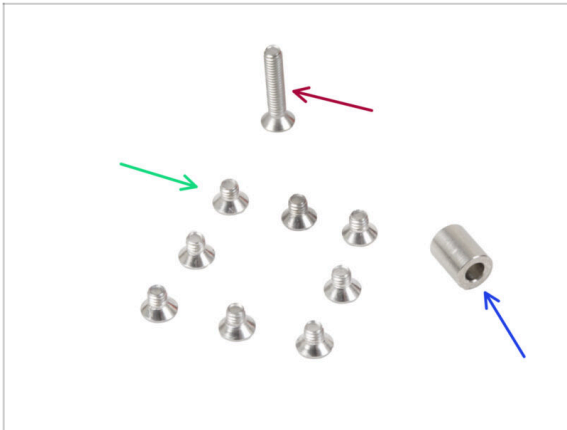

◆ For the following steps, please prepare:

◆ M3x4bT screw (8x)

◆ M3x14bT screw (1x)

◆ Spacer 6x3.1x8 mm (1x)

## STEP 37 Attaching the heatbed

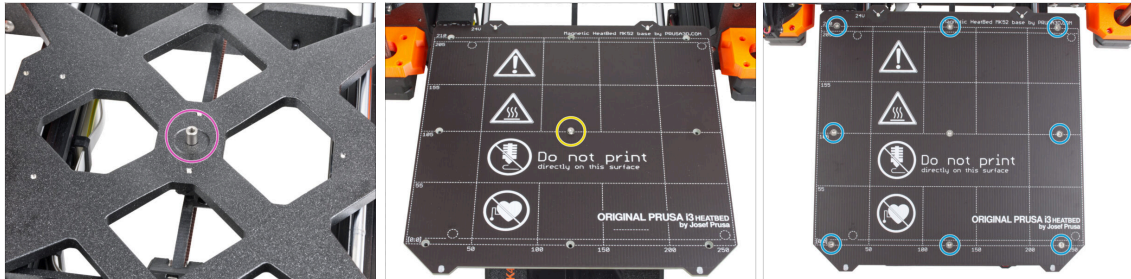

- ◆ Place the spacer onto the Y-carriage and align it with the hole in the center.
- ◆ Put the heatbed on the Y-carriage and secure it by the M3x14bT. **Do not fully tighten the screw yet.**
- ◆ Insert the M3x4bT screws into the remaining holes in the heatbed. **Do not fully tighten the screws yet.**

## STEP 38 Tightening the heatbed

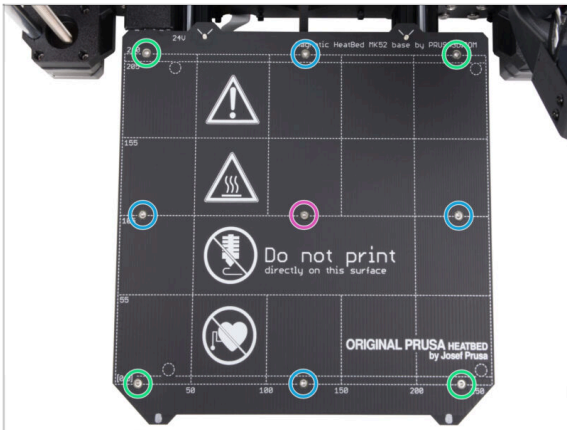

After all screws are in place, tighten them in the following sequence:

- Center screw
- First four screws (edges)
- Last four screws (corners)

**⚠ Tighten the screws gently, but firmly.**

## STEP 39 Guiding the heatbed cables: parts preparation

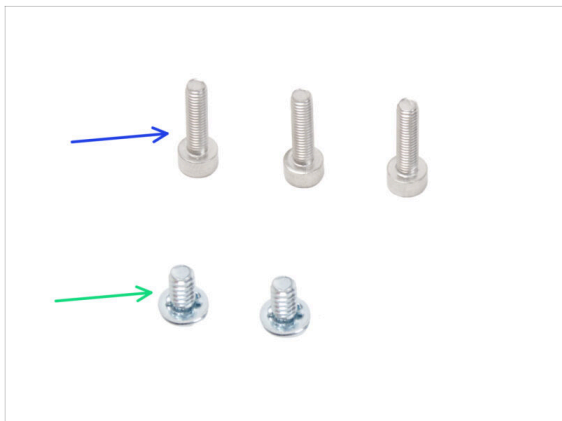

For the following steps, please prepare:

- MK4S-Wifi-cover (1x)
- ESP-WiFi (1x)
- M3x12 screw (3x)
- Power terminal screw 6/32" (2x)

**STEP 40** Assembling the Wi-Fi

- Insert the ESP-WiFi module into the WiFi-cover, positioning it just below the bridge on the left side.
- On the other side, ensure the connector fits correctly into the hole in the cover.
- Set the assembly aside for a while.

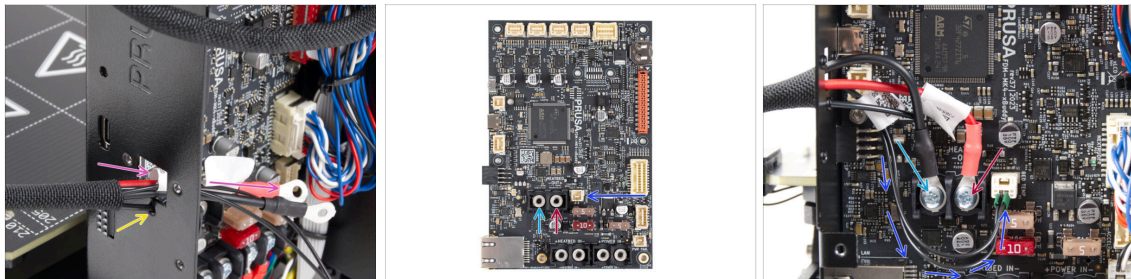



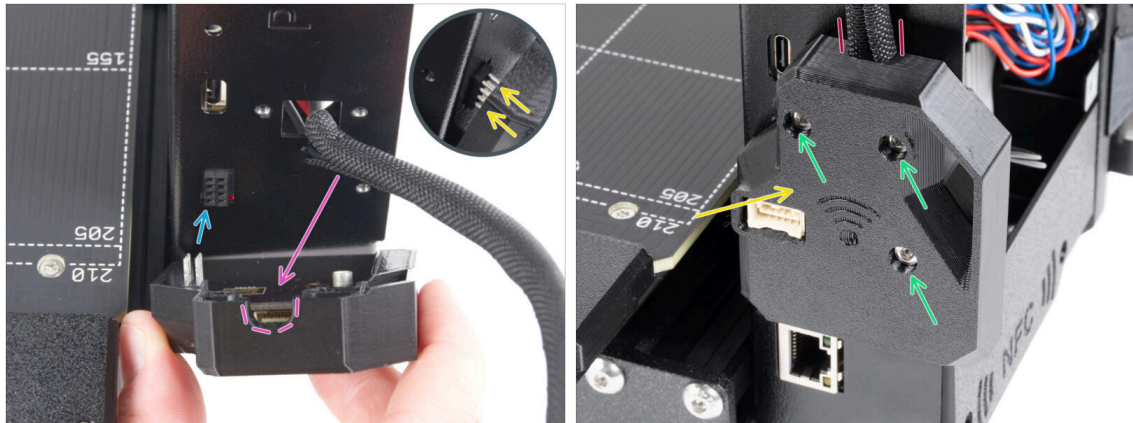

**STEP 41** Guiding the heatbed cables

- Push the heatbed cables and heatbed thermistor cable through the square opening on the back of the xBuddy Box.
- Push the filament through the circle hole right below the square opening.
- Place the **black** heatbed cable on the **left** terminal and secure it with the terminal screw.
- Place the **red** heatbed cable on the **right** terminal and secure it with the terminal screw.
- Connect the heatbed thermistor cable to the xBuddy board.



## STEP 42 Installing the WiFi cover assembly

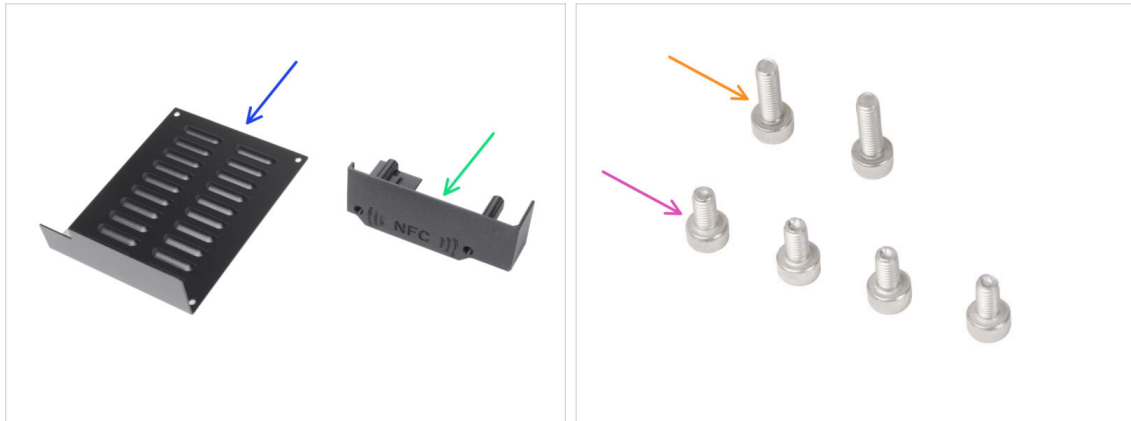

-  **Be very careful** when handling and connecting the ESP module to **avoid bending and damaging the pins**.
-  Take the WiFi cover assembly and connect the ESP module pins to the connector in the xBuddy.
-  Position the heatbed cable bundle into the cutout in the WiFi cover.
-  Close the WiFi cover carefully, ensuring the pins of the ESP module are properly engaged in the connector on the xBuddy.
-  **Double-check that the heatbed cable bundle is in place**.
-  Secure the cover with three M3x12 screws.

**STEP 43** NFC antenna: parts preparation I.

◆ For the following steps, please prepare:

◆ xBuddybox-cover (1x)

◆ El-box-cover (1x)

◆ M3x6 screw (4x)

◆ M3x10 screw (2x)

ⓘ The list continues in the next step ...

**STEP 44** NFC antenna: parts preparation II.

◆ NFCcoil (1x)

◆ Isopropyl Alcohol (IPA) Cleaning pad (1x)

◆ Adhesive film 32 x 25 mm (1x)

◆ NFC coil cable (1x)

## STEP 45 Connecting the NFC antenna

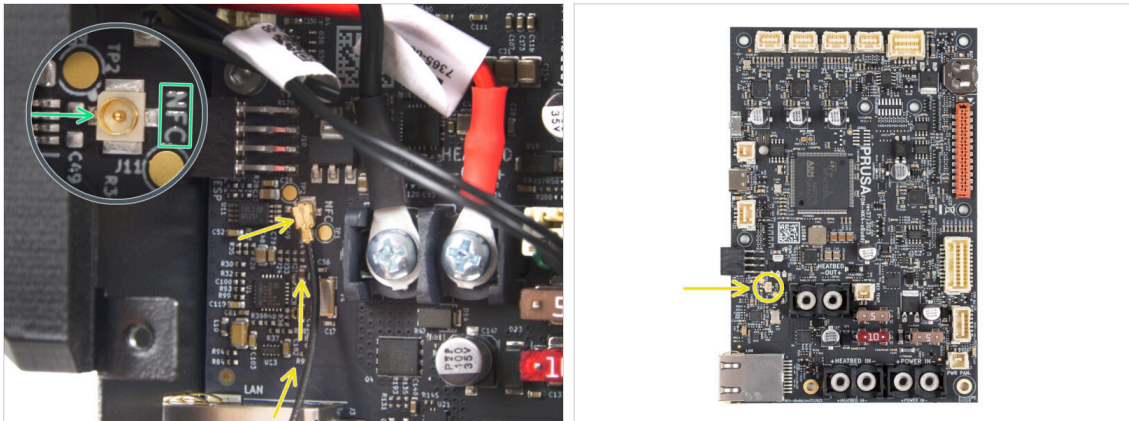

- Locate the small round connector labeled NFC on the bottom left side of the xBuddy board.
- Connect the NFC coil cable to the board by fitting the connectors together and pressing lightly until you feel a click, ensuring a correct connection.
- ⚠ **Ensure the NFC antenna cable connector is securely plugged in and does not come loose from the board.**
- ⚠ **BE EXTRA CAREFUL** when connecting the NFC coil cable connector. Excessive pressure or misalignment can cause irreversible damage.
- Leave the other end of the cable free for now.

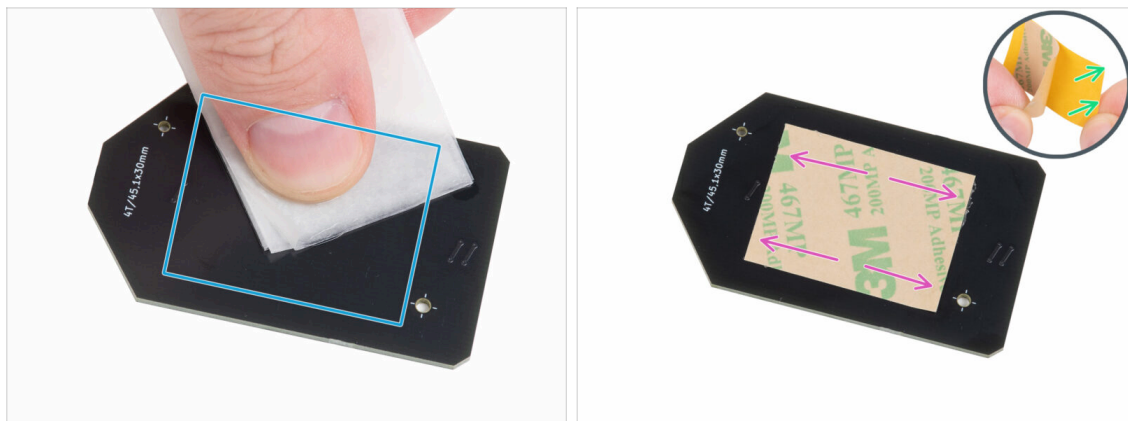
**STEP 46** Preparing the NFCcoil

- Using the IPA cleaning pad, wipe off any grease from the "underside" of the NFCcoil. The **side without the company logo**.
- ⚠️ **Avoid covering the holes in the NFCcoil board.**
- Peel off the yellow protective film from the adhesive tape.
- Stick the adhesive film on the cleaned side of the NFCcoil approximately as shown. The **side without the company logo**.
- ⚠️ **Do not put the the adhesive tape over any holes in the board!**

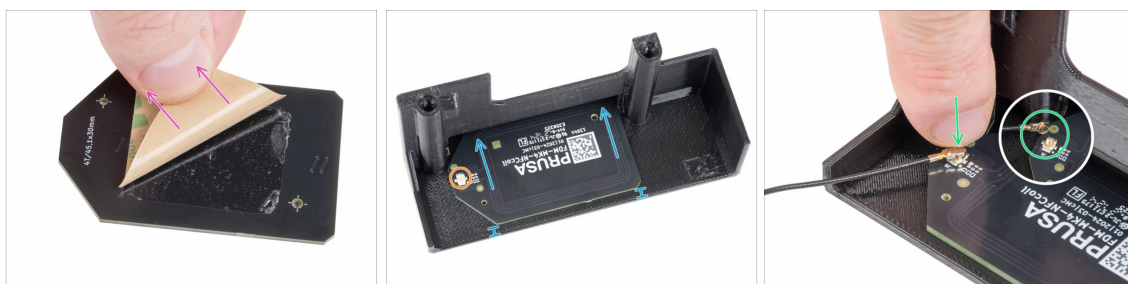
**STEP 47** Assembling the NFC antenna

- Peel of the adhesive tape paper layer from the NFCcoil.
- Stick the NFCcoil on the inner side of the EI-box-cover approximately like in the picture. **See the correct orientation of both parts!**
  - Leave at least 2mm space between the NFCcoil end the edge of the EI-box-cover.
- Locate the small round connector on the NFCcoil.
- Connect the NFC coil cable to the board by fitting the connectors together and pressing lightly until you feel a click, ensuring a correct connection.
- ⚠️ **Ensure the NFC antenna cable connector is securely plugged in and does not come loose from the board.**
- ⚠️ **BE EXTRA CAREFUL** when connecting the NFC coil cable connector. Excessive pressure or misalignment can cause irreversible damage.

## STEP 48 Verify all connections once more!

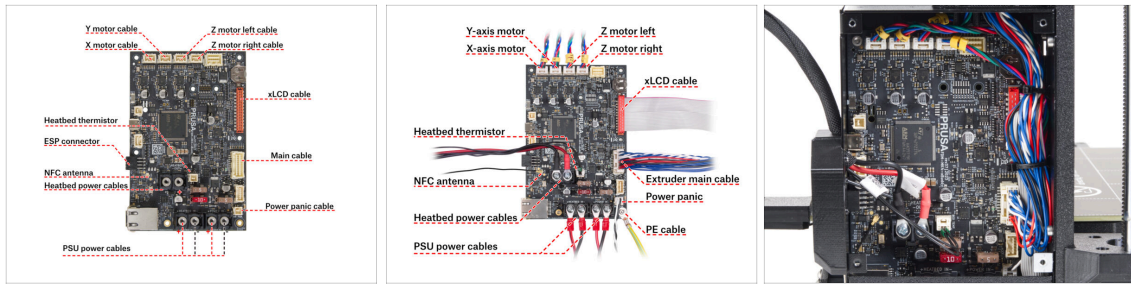

- ◆ Check your electronics connection with the first picture.
- ⚠ Before covering the electronics, check and compare your wiring.
- ◆ Compare your cable management with the third picture.
- ⚠ Make sure that all connectors are fully inserted and PSU cables properly tightened. **Otherwise, there is a risk of damage to the printer!**

## STEP 49 Covering the xBuddy box: bottom cover



- ◆ Push two M3x10 screws through the El-box-cover.
- ◆ Attach the cover to the xBuddy Box. There are two threaded holes in the xBuddy box. Make sure there is no cable in the way for the screws and the cover.
- ◆ Secure the el-box-cover by tightening both M3x10 screws to the xBuddy box.
- ⚠ **Be careful not to pinch the NFC cable when closing the cover.**

## STEP 50 Covering the xBuddy box



- ◆ Arrange the NFC coil cable to the rightmost side as shown.
  - ⚠ **Avoid routing the cable over the Ethernet connector on the left and the power cables on the right, or it may get pinched and damaged when covering the electronics box.**
- ◆ Carefully cover the xBuddy box by first sliding the bent part of the cover into the box.
  - ⚠ **Avoid pinching the cables. Double-check the NFC coil cable position.**
- ◆ Align the xBuddy box cover with the xBuddy box and secure it with four M3x6 screws.

## STEP 51 Assembling the double spool holder (part 1)

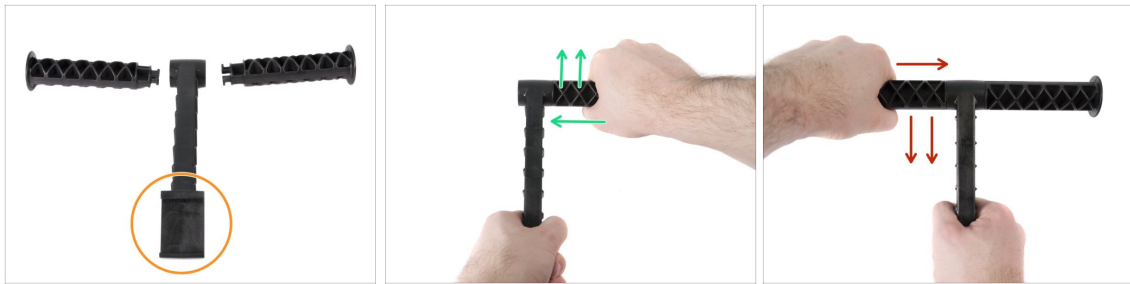

- ◆ **For the following steps, please prepare:**
  - ◆ Centre part (1x)
  - ◆ Side arm (2x)

**STEP 52** Assembling the double spool holder (part 2)

**⚠ Don't use excessive force during the assembly, or you might damage the spool holder locking system.**

- 🟡 Place all three parts in front of you. Note both "arms" are identical. Make sure the C shaped part, which will snap on the printer's frame is facing towards you.
- 🟢 Take the "arm" on the right side, insert it gently in the main part and start to rotate clockwise (away from you). It should take about half the turn to lock the part in place.
- 🟠 Take the "arm" on the left side, insert it gently in the main part and start to rotate anticlockwise (towards you). It should take about half the turn to lock the part in place.
- 📄 **i** The assembly requires a very small force (torque). If you experience issues, check first the locking mechanism for obstacles.

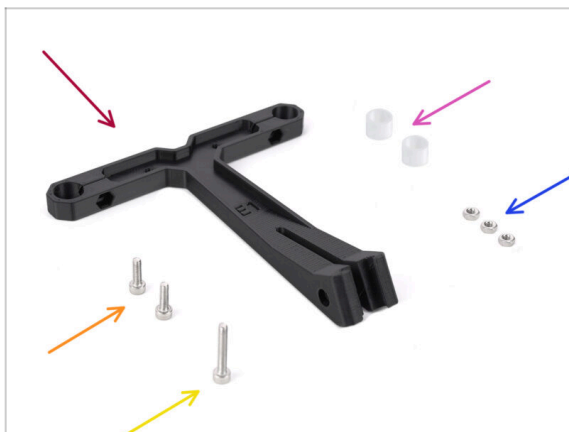
**STEP 53** Assembling the Filament guide: parts preparation

🔹 **For the following steps, please prepare:**

- 🟠 Filament-guide (1x)
- 🟡 Filament guide PTFE tube (2x)
- 🟢 M3n nut (3x)
- 🟠 M3x18 screw (1x)
- 🟡 M3x10 screw (2x)

**STEP 54** Filament guide assembly (part 1)

- ◆ Insert two M3n nuts into the marked openings.
- ◆ Use the longer M3x18 screw as a handle for inserting the nut.
- ◆ Insert the two PTFE tubes into the marked openings.
- ◆ Fix the tubes in place with two M3x10 screws from the other side.
- ◆ Insert the third M3n nut into the opening on the side.

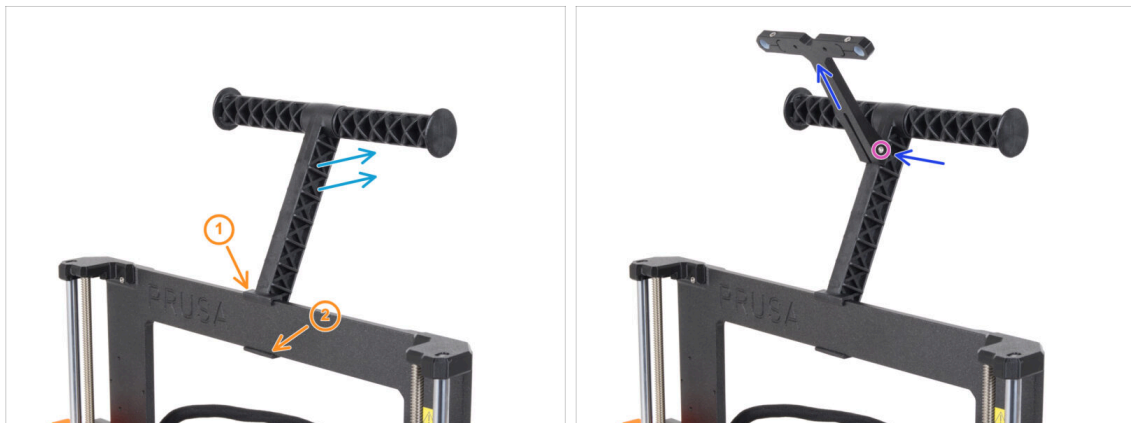
**STEP 55** Filament guide assembly (part 2)

- ◆ Attach the spoolholder onto the **middle** of the printer's frame.
- ◆ Make sure the spool holder is inclined towards the back of the printer.
- ◆ Attach the filament guide onto the spool holder.

It should click in inbetween the top two ribs, pointing upwards, as seen in the photo.

- ◆ Fix the guide in place using M3x18 screw.



## STEP 56 Haribo time!



- ◆ Eat another five gummy bears.
- ⓘ **Did you know that** the bright colors of gummy bears are achieved through the use of food coloring, which adds to their visual appeal.

## STEP 57 That's it



- ◆ That was tough. But you made it!
- ◆ Let's move to the last chapter: **8. Preflight check**

## 8. Preflight check



## STEP 1 Attaching the steel sheet

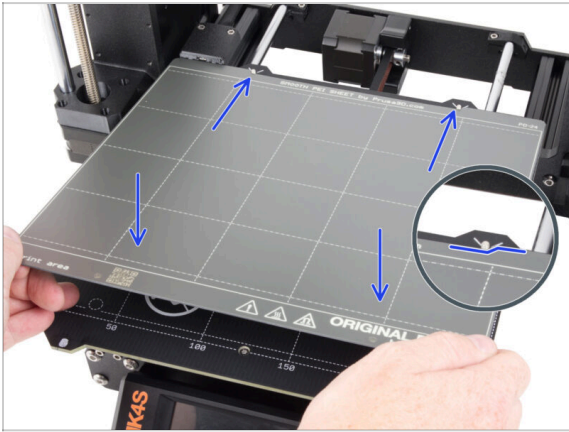

**⚠** Make sure there is nothing on the heated bed. The heated bed must be clean. Any dirt can damage the surface of both the heated bed and the steel sheet.

**🔵** Attach the sheet by first aligning the rear cutout with the locking pins on the back of the heated bed. Hold the sheet by the front two corners and slowly lay it down onto the heated bed - **watch your fingers!**

🔸 Keep the **steel sheet** clean for optimum performance.

🔸 #1 cause of prints detaching from the print surface is a greasy steel sheet. **Use IPA (Isopropyl alcohol) to degrease it** if you have touched its surface before.

**i** We are using a steel sheet with a smooth surface. However, the same procedure applies to other variants.

## STEP 2 First run



**🔵** Insert the USB drive included in your kit into your printer.

**i** The included USB drive contains the latest firmware file.

**🟣** Connect the power cable and connect the printer into a wall outlet.

**🔴** Turn the printer on using the switch on the back.

**i** The printer will now detect if a new firmware file is available on the USB drive.

**🟠** If the "New firmware available" screen appears, hit **FLASH** by pressing the rotary knob to upgrade to the latest firmware.









🔸 If no such message appears, the printer is running the latest firmware already. Proceed to the next step.

## STEP 3 Printer setup





- After upgrading to the newer firmware, the printer will give you a choice of languages and then the welcome screen.
- Hit **OK** to setup the printer.
- On the Printer setup screen, select your printer type if it is not already set as the default.
- Leave the other items unchanged unless you have installed custom parts on the printer (e.g., nozzle with a different diameter, silicone sock removal).
- Hit **Done** to complete the printer setup.

**STEP 4** Network setup: Wi-Fi connection (Optional)

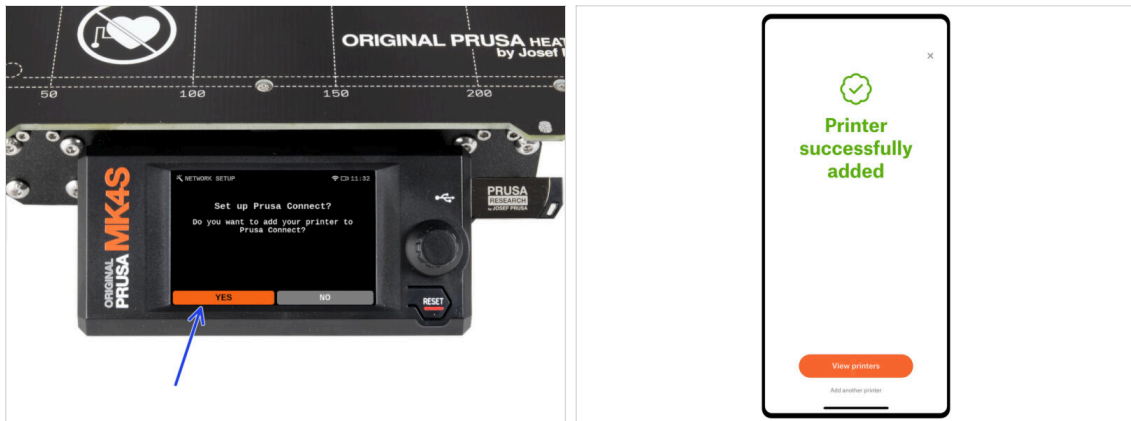
-  The Network setup screen will take you through connecting to a Wi-Fi network. However, if you don't want to connect your printer now, you can do so at any time later. In that case, hit **No** on the screen and skip this step.
-  If you want to connect your printer to a Wi-Fi network, hit **Yes**.
-  On the following screen, you will be instructed to upload your Wi-Fi credentials (Wi-Fi name and password) via our mobile application (recommended).
-  The **Prusa** app is available for download on the App Store for iOS and Google Play Store for Android. For more about the Prusa app, read the article [Prusa Mobile App](#).
-  However, if you prefer to use another method to enter your Wi-Fi credentials, select **Cancel** and chose other method from the list on the next screen.
-  All methods for connecting the printer to the network are described in the [Network Connection](#) article.
-  To send Wi-Fi credentials via the mobile app, follow the instructions on the printer screen. The transfer is via NFC, so when prompted by the app, hold your phone close to the NFC antenna at a maximum of 2-3 cm away.
-  After successful data transfer, you will be prompted on the printer to confirm and then connect.

**STEP 5** Network setup: Prusa Connect (Optional)

-  The next Network setup screen will offer to add the printer to Prusa Connect. If you do not want to add the printer to Prusa Connect now, you can do so at any time later. Hit **No** and skip this step.
-  For more about read the article [Prusa Connect and PrusaLink explained](#).
-  To continue with the instructions to add the printer to Prusa Connect, hit **Yes**. And follow the instructions on the printer screen. Ensure you have the Prusa mobile app ready on your phone.

## STEP 6 Wizard - Selftest start



- ◆ The printer will prompt you to run selftests and calibrations for all important components. The entire process takes a few minutes, with some parts requiring direct user interaction.
- ⚠ **NOTE:** While testing the axes, make sure that there is nothing in the printer obstructing the axes movement.
- ⚠ **WARNING:** Do not touch the printer during the self-test unless prompted! Some parts of the printer may be **HOT** and moving at high speed.
- ◆ The wizard starts with the fan check, Z-axis alignment and the X&Y axis test; all fully automatic.
- ◆ Hit **Yes** to run the selftests and calibrations.

## STEP 7 Wizard - Loadcell Test



- ◆ The next step of the wizard will prompt you to touch the nozzle to test and calibrate the Loadcell. During this procedure, the parts of the printer are not heated up so that you can touch them. Click **Continue**.
- ◆ Do not touch the nozzle yet, wait until prompted by the **Tap nozzle NOW** message.
- ◆ Tap the nozzle from below. In case the Loadcell does not detect the touch, you will be prompted to repeat the step. Otherwise, you will see **Loadcell test passed OK** when it succeeds.

## STEP 8 Wizard - Gearbox Alignment



- 🟡 Once you get to the Gearbox Alignment part, select **Continue** and follow the on-screen instructions.
- 🔴 Undo the idler lock (swivel), then open the idler door.
- 🟢 Loosen the three screws on the front of the gearbox by 1.5 turns.
- 📄 **i** The printer will go through the automatic gearbox alignment. This process can't be seen from the outside.
- 🟢 Once prompted, tighten the three screws in the pattern indicated on the screen.

## STEP 9 Wizard - Filament Sensor Calibration



- 🟡 During the filament sensor calibration, you will need to use a short piece of filament. Prepare the filament and select **Continue**. There should be no filament inside the extruder before the start of the calibration process.
- 📄 **i** There should be no filament inside the extruder before the calibration process starts.
- 🔴 Once prompted to, insert the filament end into the opening on top of the extruder.
- ⬛ Remove the filament after the calibration finishes.



## STEP 10 Wizard complete



- Only after all selftests and calibrations are successfully completed you can almost begin printing, but wait. Hit **Continue**.

## STEP 11 Reward yourself!



- It looks like you have successfully assembled and connected everything. No doubt ;). **Congratulations!** You deserve a big reward for that. Eat all the remaining gummy bears... and don't forget to share with those who supported you during the assembly.
- i** **Did you know that** Haribo gummy bears are one of the most important parts of the Original Prusa printers assembly instructions.

## STEP 12 Loading a filament



- Add a spool or a sample of your favourite filament onto either side of the spool holder.
  - Guide the filament end through the filament guide into the extruder. Using the filament guide prevents filament tangling.
  - Once a filament is detected, the printer will load it automatically. It is important to select the correct type of filament you are using on the screen. We recommend using **PLA** material for the first test print.
  - The printer will purge some of the material through the nozzle. Confirm its color is clear by selecting **YES** on the screen and remove the leftover plastic from below the nozzle.
- ! Proceed carefully, the nozzle is now very **HOT!** Do not touch it with your bare hands!

## STEP 13 Printable 3D models

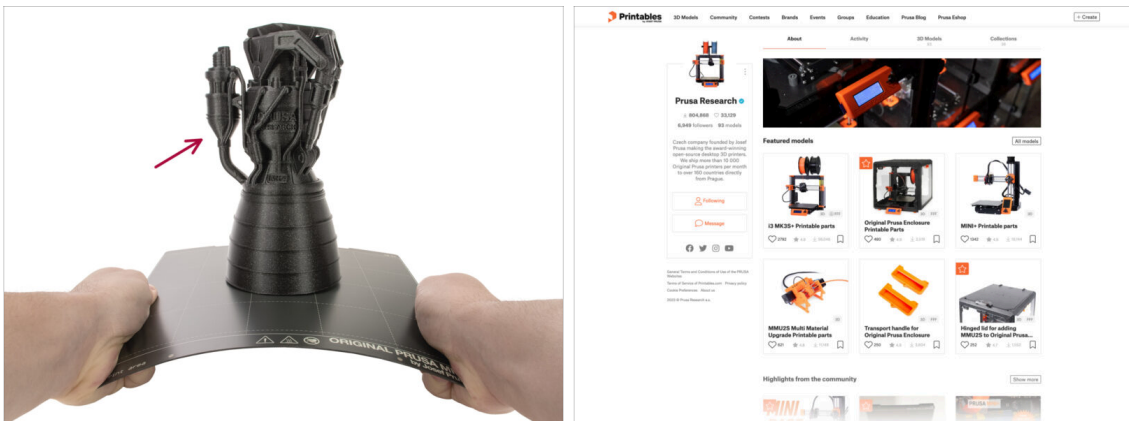

- **The printer is now ready to print!**
- You can start by printing some of our test objects from the bundled USB drive.
- The sample objects are also available on the official [Prusa Research Printables profile](#)

## STEP 14 Firmware update

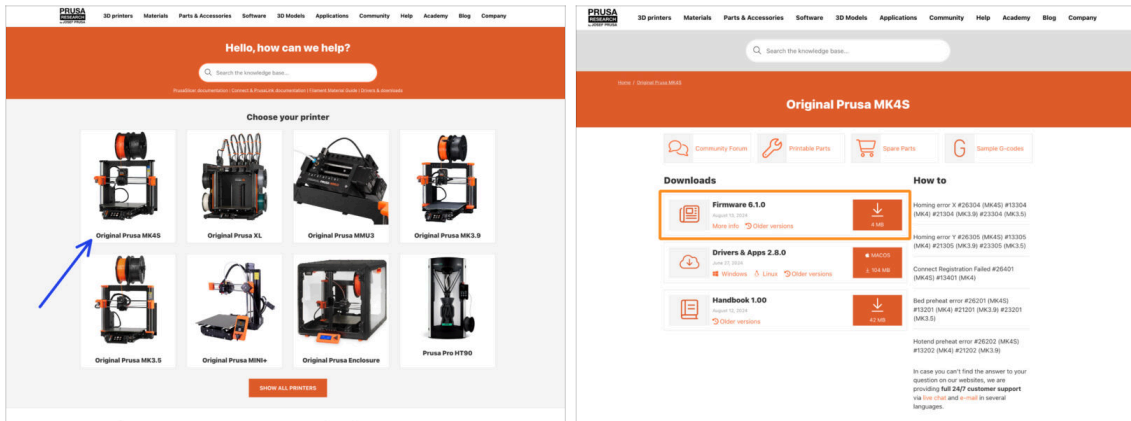

- ❗ All shipped kit units have the latest firmware version. However, it is recommended to check and possibly upgrade the firmware version.
- 🛒 Visit the [help.prusa3d.com](https://help.prusa3d.com) page.
- 🔍 Navigate to the Original Prusa MK4S page.
- 📁 Save the firmware file (*.bbf*) onto the *bundled USB drive*.
- ❗ Pro tip: To access MK4S homepage you can use the URL: [prusa.io/mk4s](https://prusa.io/mk4s)

## STEP 15 PrusaSlicer for MK4S

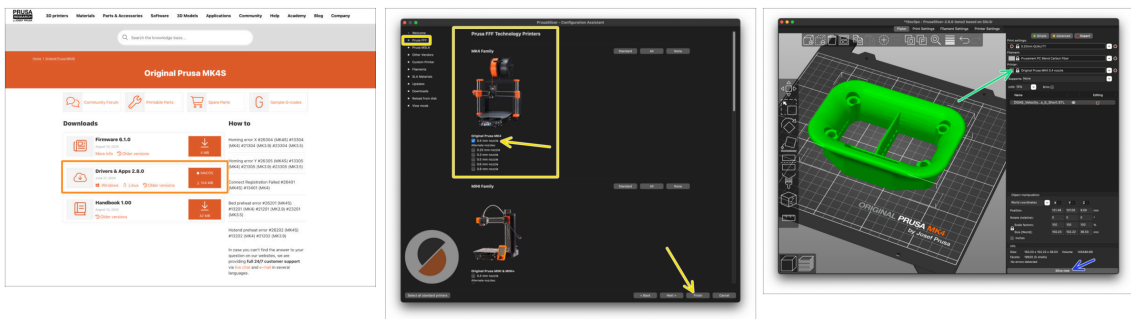

- 🛒 Ready to print your own models?
- 🛒 Visit [help.prusa3d.com](https://help.prusa3d.com) once again. Download and install the latest **Drivers & Apps** package onto your computer. This package includes the **PrusaSlicer** app.
- 🟡 Open the **PrusaSlicer** app. If you're running it for the first time, Configuration Wizard will show up. Visit the Prusa FFF tab in the Wizard, select **Original Prusa MK4S** in the **0.4mm nozzle** version (the default nozzle size) and hit **Finish** to start using the MK4S printer profile.
- 🟢 Make sure the Original Prusa MK4S is selected in the Printer menu on the right, when slicing for the MK4S.
- 🔍 **Import a model** of your choice into PrusaSlicer, adjust the settings if needed, hit **Slice** and export the G-code file onto the USB drive to print it on your MK4S..

## STEP 16 PrusaLink & Prusa Connect

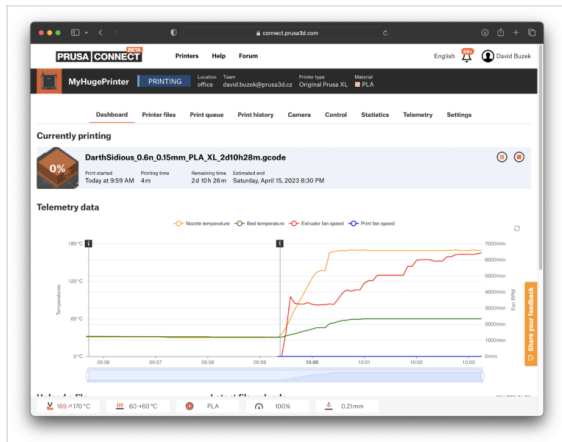
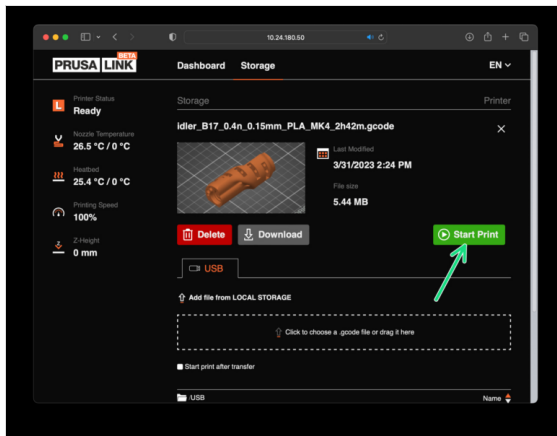

- ◆ Did you know you can print and control the printer over the local network with **PrusaLink** or from anywhere in the world using **Prusa Connect**?
- ⓘ Read [the article about PrusaLink and Prusa Connect](#) to get general information about these services.

## STEP 17 Quick guide for your first prints



- 📌 Please read the **3D Printing Handbook** dedicated to your printer and follow the instructions to set up and use the printer properly. The latest version is always available at [help.prusa3d.com](http://help.prusa3d.com).
- ⚠️ Read the **Disclaimer and Safety instructions** chapters.

## STEP 18 Prusa knowledge base

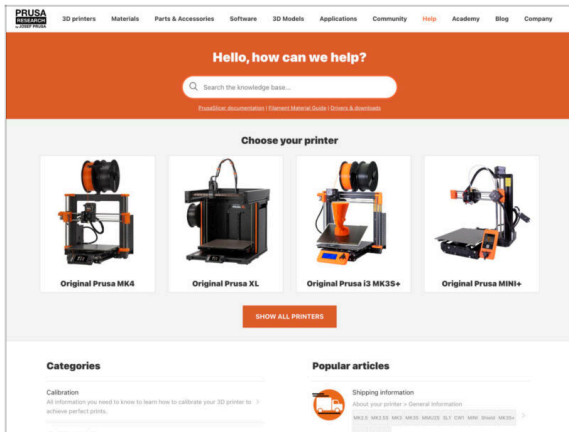



If you encounter any problems at all, don't forget you can always check out our knowledge base at [help.prusa3d.com](https://help.prusa3d.com)



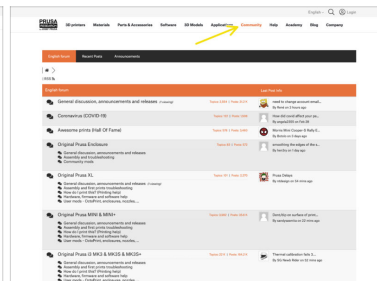
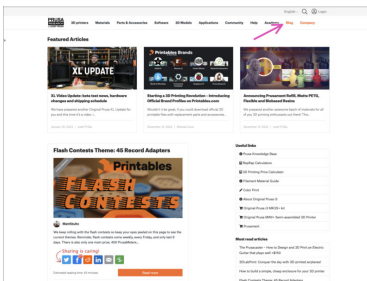
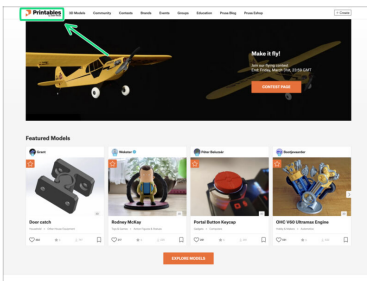

We're adding new topics every day!

## STEP 19 Join Printables!



- 

Don't forget to join the biggest Prusa community! Download the latest models in STL or G-code tailored for your printer. Register at [Printables.com](https://printables.com)
- 

Looking for inspiration on new projects? Check our blog for weekly updates.
- 

If you need help with the build, check out our forum with a great community :-)
- 

All Prusa services share one user account.

# Manual changelog

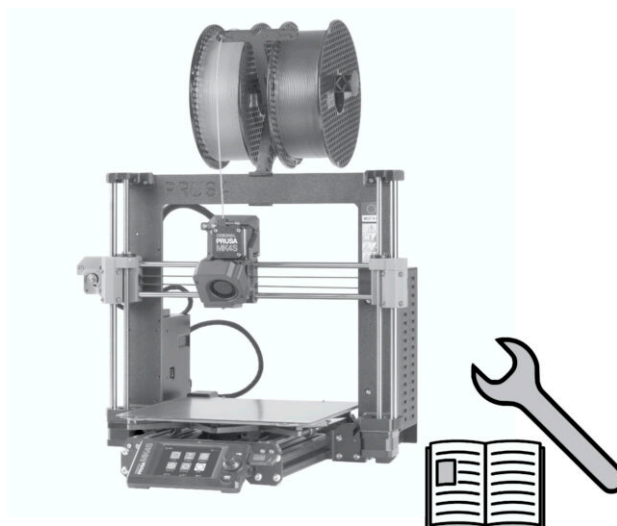

## STEP 1 Version history

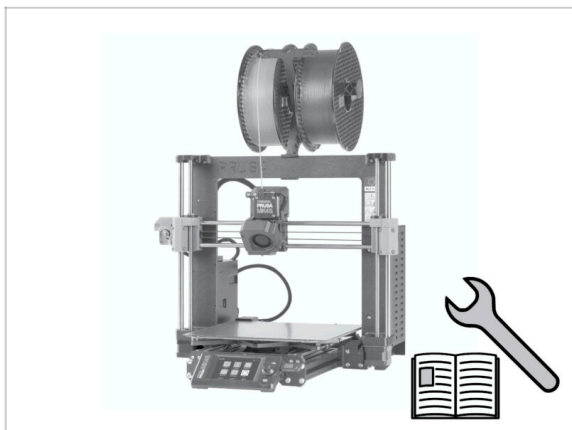

- ◆ **Versions of the MK4S kit manual:**
- ◆ 08/2024 - Initial version 1.00











