

UT219PV User Manual



Preface

Thank you for purchasing this brand new product. In order to use this product safely and correctly, please read the User Manual thoroughly, especially the “Safety Information” section.

It is recommended to keep this manual at an easily accessible place, preferably close to the device, for future reference.

Limited warranty and liability

This Uni-Trend product will be free from defects in material and workmanship for one year from the date of purchase. This warranty does not cover fuses, disposable batteries, or damage from accident, neglect, misuse, alteration, contamination, or abnormal conditions of operation or handling. Resellers are not authorized to extend any other warranty on behalf of Uni-Trend. To obtain service during the warranty period, contact your nearest Uni-Trend authorized service center to obtain return authorization information, then send the product to that Service Center with a description of the problem.

This warranty is your only remedy. No other warranties, such as fitness for a particular purpose, are expressed or implied. Uni-Trend is not liable for any special, indirect, incidental or consequential damages or losses, arising from any cause or theory. Since some states or countries do not allow the limitation of an implied warranty and of incidental or consequential damages, this limitation of liability may not apply to you.

Warning:

Measuring voltage over 1500V applies to the measurement positions “2500V DC/1500V AC” and “VA/V+A” only! Do not input voltage over 1500V to other measurement positions. Otherwise, it can pose a risk of damaging the Meter!

Contents

I. Overview-----	4
II. Features-----	4
III. Accessories-----	4
IV. Safety Information-----	5
V. Electrical Symbols-----	6
VI. General Characteristics-----	6
VII. External Structure-----	7
VIII. Rotary Switch-----	8
IX. Button Functions-----	9
X. LCD Display-----	10
XI. Operating Instructions-----	12
XII. Other Functions-----	21
XIII. Technical Specifications-----	21
XIV. Bluetooth-----	25
XV. Maintenance-----	26

I. Overview

UT219PV is a True-RMS AC/DC clamp meter (abbreviated as "Clamp Meter") specially designed for photovoltaic high-voltage environments. It can be used to measure AC/DC voltage, AC/DC current, LPF voltage/current, inrush current, peak current, DC power, flex current sensor, resistance, continuity, diode, capacitance, temperature, and more. UT219PV has data storage function and Bluetooth function, which enable remote control and monitoring on the measurement data via the "UNI-T Smart Measure" APP. UT219PV is an ideal meter for the installation and maintenance in photovoltaic field. This Clamp Meter can also be applied in the energy storage system, UPS (uninterrupted power supply), large-scale motor, and other high voltage environments.

II. Features

- 1) Measure 2500V DC, 1000A DC, and DC power of 2500KW.
- 2) Measure 1500V AC, 1000A AC. The flex current sensor can measure current up to 3000A AC.
- 3) Bluetooth transmission function: Enable remote control and monitoring via the APP.
- 4) Low pass filter (LPF) measurement for AC voltage/current.
- 5) AC inrush current and peak value (PEAK) measurement
- 6) Dual displays to show voltage/frequency, current/frequency, DC voltage/current, and DC power/current at the same time.
- 7) Temperature measurement (Degrees Celsius/Fahrenheit)
- 8) Data storage function
- 9) The ability to connect flex current sensor.
- 10) IP65 rating: Suitable for outdoor uses particularly, such as solar array, wind energy system, etc.
- 11) Slim clamp jaws (jaw opening: 35 mm) to allow measurement for concentrated cables, inverter, copper busbar of combiner box, etc.

III. Accessories

Please carefully check if any accessory below is missing or damaged.

- 1) User manual: 1 pc
- 2) Test leads (UT-L88): 1 pair
- 3) Test leads (UT-L95): 1 pair (optional)
- 4) Temperature probe: 1 pc
- 5) Carrying case: 1 pc
- 6) AA 1.5V battery: 2 pcs
- 7) UT-CS09D flex current sensor: 1 pc (optional)
- 8) Magnetic hanger: 1 set (optional)

Please contact your local distributor if any accessory is missing or damaged.











IV. Safety Information

Please pay attention to the warning labels and messages. A Warning identifies hazardous conditions and procedures that are dangerous to the user. A Caution identifies conditions and procedures that can cause damage to the product or the equipment under test.

The product is designed in accordance with IEC/EN61010-1, 61010-2-032, 61010-031, and Electromagnetic Radiation Protection of EN61326-1, and conforms to Double Insulation, Overvoltage CAT III 1500V/CAT IV 600V, and Pollution Degree 2, indoor use. If the product is not used according to the operating instructions, the protection supplied by the product can be compromised or lost.

- 1) Please check the product and test leads before use to avoid any damage or problem. Please stop use if exposed test lead, damaged case, abnormal display and other problems occur.
- 2) It is forbidden to use without the cover closed in place. Otherwise it may present a risk of electric shock.
- 3) If the test lead is damaged, please replace with new test lead (its rated parameter shall conform to the product or be higher) meeting EN 61010-031.
- 4) Do not touch the exposed wire, connector, unused input terminal or circuit during measurement.
- 5) Use caution when working with voltages over 60V DC, 30Vrms AC, or peak voltage over 42.4V. Keep fingers behind the tactile barrier.
- 6) Set the product to maximum range if the measured value is unknown.
- 7) Do not exert voltage over the specified value between terminals or between any terminal and earth ground.
- 8) Set the rotary switch to correct position for measurement. Disconnect the test leads from the measured circuit before turning the rotary switch. It is forbidden to switch over during measurement to prevent product damage.
- 9) Before measuring in-circuit resistance, diode, circuit, please disconnect all powers in the circuit of measured object and discharge all capacitors thoroughly.
- 10) Do not use the product in a circuit with voltage over the rated value.
- 11) To avoid electric shock, please disconnect the test probe from the measured circuit before opening the battery cover or rear cover.
- 12) Grip the probe behind the finger protector during the use of the probe.
- 13) Do not keep or use the product in environments with high temperature, high humidity, strong electromagnetic field, or inflammable and explosive substances.
- 14) Do not alter the internal wiring without authorization to avoid product damage and safety hazard.
- 15) When the symbol " appears on the LCD, please replace the battery in time to ensure measurement accuracy.
- 16) Switch off the power after completing measurement. Remove the batteries when the product is not in use for an extended period of time.
- 17) Please measure a known intrinsic voltage before use to ensure the product works normally.
- 18) Please use the product according to the User Manual, otherwise the supplied protection will be lost.
- 19) Please wipe the case with wet cloth and neutral cleaning agent. Do not use abrasives or solvents.

V. Electrical Symbols

Symbol	Description	Symbol	Description
	Do not place equipment and its accessories in trash. Items must be properly disposed of in accordance with local regulations.		Double insulated
	AC (Alternating Current)		Grounding
	DC (Direct Current)		Warning
	Application around and removal from UNINSULATED HAZARDOUS LIVE conductors is permitted.		Low battery
	Adopting Bluetooth communication technology		
	Conforms to European Union directives		Conforms to UL STD 61010-1, 61010-2-032, 61010-031 Certified to CSA STD C22.2 NO. 61010-1, 61010-2-032, 61010-031
CAT III	MEASUREMENT CATEGORY III is applicable to test and measuring circuits connected to the distribution part of the building's low-voltage MAINS installation.	CAT IV	MEASUREMENT CATEGORY IV is applicable to test and measuring circuits connected at the source of the building's low-voltage MAINS installation.

VI. General Characteristics

- Display count: 9999
- Polarity indication: Auto
- Overload indication: "OL" or "-OL"
- Low battery indication: The symbol " appears on the LCD to indicate the battery voltage is lower than the working voltage. Please replace the batteries with new ones in time.
- Position error: An error of $\pm 1.0\%$ will be produced if the measured object is not located at the center of the clamp jaws.
- Drop proof: 1 m
- Jaw opening: 35 mm
- Power supply: AA 1.5V battery $\times 2$
- Auto power off: No operation for about 15 minutes will turn off the Clamp Meter. This function can be disabled if needed.
- Dimensions: 295 mm \times 73 mm \times 50 mm
- Weight: 540g approx.
- Operating altitude: 2000 m

- Protection degree: IP65
 - Operating temperature and humidity: 0°C~30°C (≤80%RH); 30°C~40°C (≤75%RH); 40°C~50°C (≤45%RH)
 - Storage temperature and humidity: -20°C~+60°C (≤80%RH)
- Electromagnetic compatibility: In an RF field of 1 V/m, total accuracy = specified accuracy + 5% of range; In an RF field of over 1 V/m, there is no specified specification.

VII. External Structure

1: UT219PV structure (Figure 1)

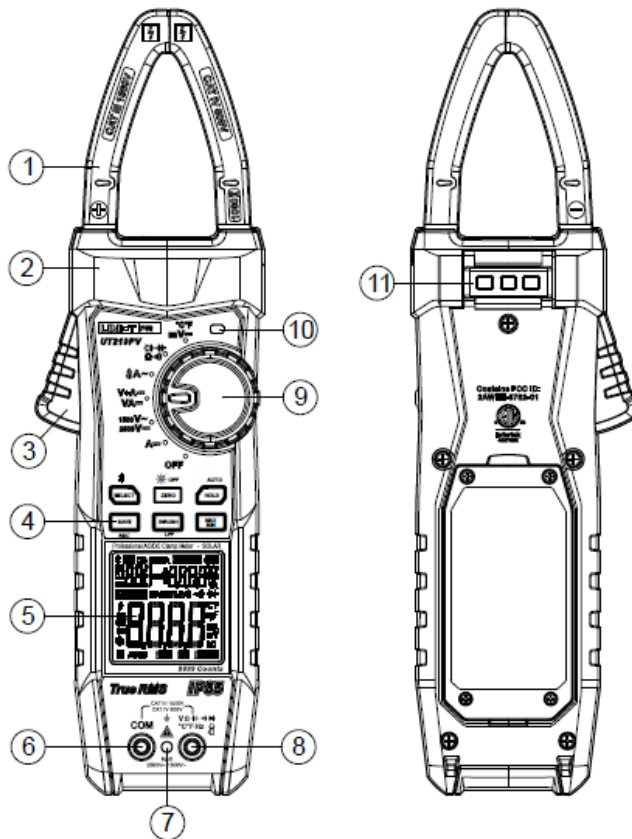

Figure 1

- 1) Clamp jaw
- 2) Tactile barrier
- 3) Trigger
- 4) Functional buttons
- 5) LCD display
- 6) COM terminal (connected with black test lead)
- 7) Light-guide area for infrared transmission
- 8) Signal input terminal (connected with red test lead)
- 9) Rotary switch
- 10) Light-sensitive area
- 11) For hanging strap

VIII. Rotary Switch (Figure 2)

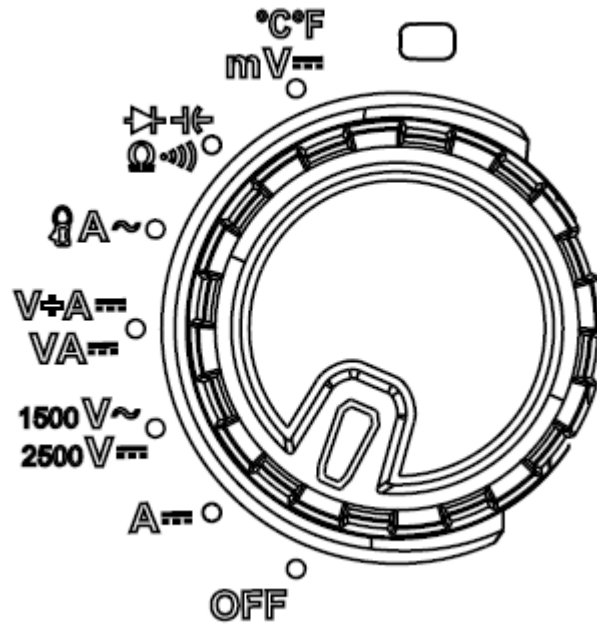

Figure 2

Position	Description
OFF	Power off
A~	DC current measurement
V~ / V~	AC/DC voltage measurement
VA/V+A	DC power measurement/DC voltage + DC current measurement
⌚ / A~	Flex current sensor measurement/AC current measurement (clamp jaws)
••• / Ω / ▶ / ⊕	Continuity/resistance/diode/capacitance measurement
mV~ / °C/°F	mV AC/DC current measurement/Temperature measurement

IX. Button Functions (Figure 3)

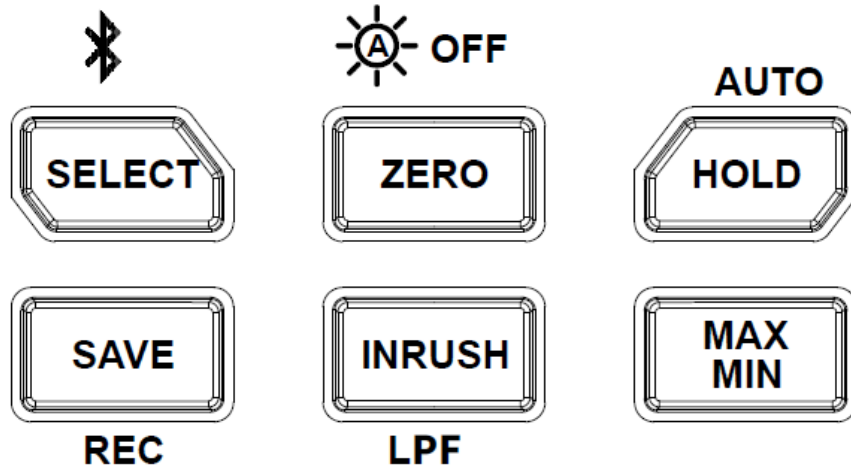





Figure 3

Short press: Press for <2 s

Long press: Press for ≥2 s

Button	Description
	<p>Short press:</p> <ol style="list-style-type: none"> 1) DCV/ACV position: Short press to select DCV and ACV positions cyclically. Default position: DCV 2) VA/V+A position: Short press to select VA and V+A positions cyclically. Default position: VA 3) ACA (Clamp jaw)/ACA (Flex current sensor) position: Automatically identify sensor and switch to the flex current sensor and corresponding position (No need to use SELECT). 4) Ω/Diode/CAP position: Short press to select Ω, diode, and CAP positions cyclically. Default position: Ω 5) DCmV/°C °F: Short press to select DCmV and °C °F cyclically. Default position: DCmV <p>Long press:</p> <p>Long press to turn on/off Bluetooth communication.</p>
	<p>Short press to zero the residual reading of DCA.</p> <p>Long press to turn on/off the automatic backlight function.</p>
	<p>Short press to turn on/off the data hold mode.</p> <p>Long press to turn on/off the automatic hold mode (See “Table of Auto Hold Function”)</p>

	<p>Short press: With Bluetooth off: Short press to save measurement data once in UT219PV. With Bluetooth on: Short press to start one-time recording via mobile phone.</p> <p>Long press: With Bluetooth off: Long press to save measurement data continuously in UT219PV. With Bluetooth on: Long press to start continuous recording via mobile phone.</p> <p>Note: 1. Clear the data saved in the Clamp Meter: Hold down INRUSH and press SELECT while turning on the Clamp Meter (by turning the rotary switch), then “cLr?” appears on the LCD. Press SELECT a second time, then “ErAS” is displayed on the LCD. When data clearing is done, “done” appears on the LCD. 2. Maximum 999 sets of data can be saved in the Clamp Meter.</p>
	<p>Short press to turn on/off the inrush current and peak current measurement function. For ACA and CS_A (Flex current sensor).</p> <p>Long press to turn on/off the low pass filter function. For ACV, ACA, and CS_A (Flex current sensor).</p>
	<p>Short press to select MAX, MIN, and AVG cyclically.</p> <p>Long press to exit MAX/MIN/AVG mode</p>

X. LCD Display (Figure 4)

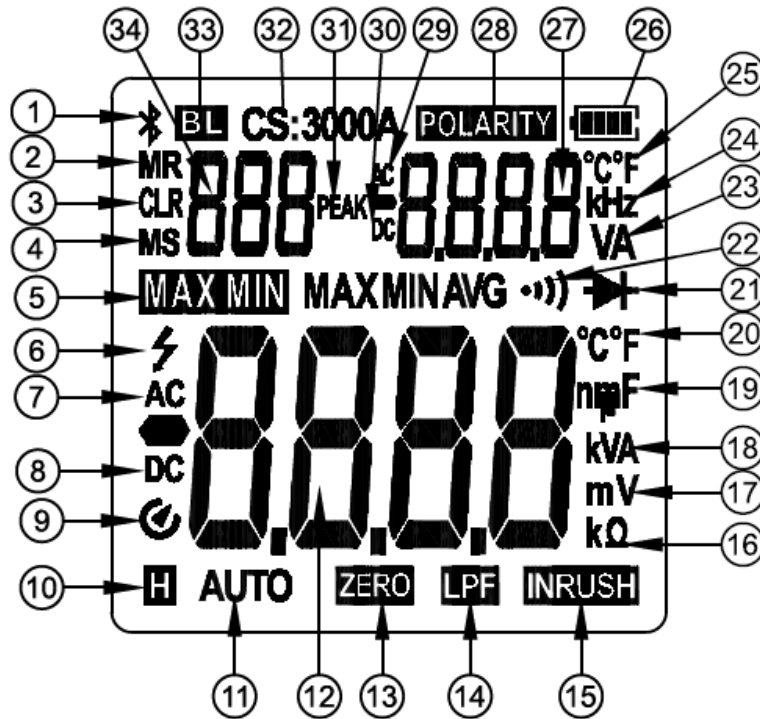



Figure 4

1	Bluetooth	2	Auto-save data
3	Clearing storage data	4	Recording data
5	Max/Min/Average measurement	6	Hazardous voltage
7	AC measurement	8	DC measurement
9	Auto power off	10	Data hold
11	Auto data hold	12	Displayed value (main display)
13	Zero the residual reading of DC current	14	Low pass filter
15	Inrush measurement	16	Resistance unit
17	Voltage unit	18	Current/Power unit
19	Capacitance unit	20	Temperature (main display)
21	Diode measurement	22	Continuity measurement
23	Voltage/Current unit (sub-display)	24	Frequency unit
25	Temperature (sub-display)	26	Low battery
27	Displayed value (sub-display)	28	Polarity
29	AC measurement (sub-display)	30	DC measurement (sub-display)
31	Peak measurement	32	Connect flexible current sensor
33	Backlight	34	Number of saved data

XI. Operating Instructions

Please check the built-in batteries (AA 1.5V × 2) before use. If low battery occurs after the Clamp Meter is turned on, the symbol “” will be displayed on the LCD. To ensure measurement accuracy, please replace the batteries in time. The warning symbol “” at the terminal indicates the measured voltage/current shall not exceed the specified value.

1. Measuring DC current using the clamp jaws (Figure 5)

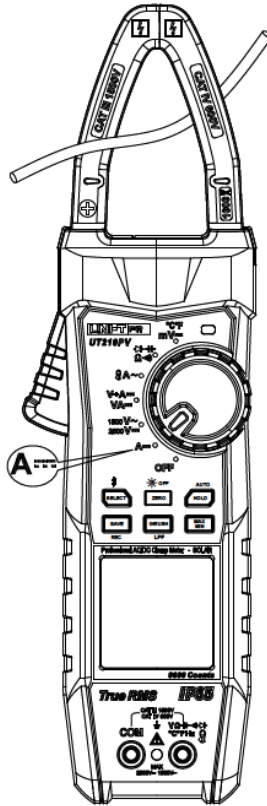



Figure 5

- 1) Set the rotary switch to “”.
- 2) Press and hold the trigger to open the clamp jaws, clamp the conductor to be measured, then release the trigger slowly to close the clamp jaws completely.
- 3) Read the measurement result from the LCD.

Warning:

- Please measure one current conductor only at a time. Otherwise the measurement result will be incorrect.
- To ensure an accurate measurement result, please set the measured conductor at the center of the clamp jaws. Otherwise an additional error of $\pm 1.0\%$ will be produced.

- If residual reading occurs for DC current measurement, please press the ZERO button to clear the residual reading.
- “OL” will be displayed when measuring DC current of ≥ 1000 A.

2. AC/DC voltage measurement (Figure 6)

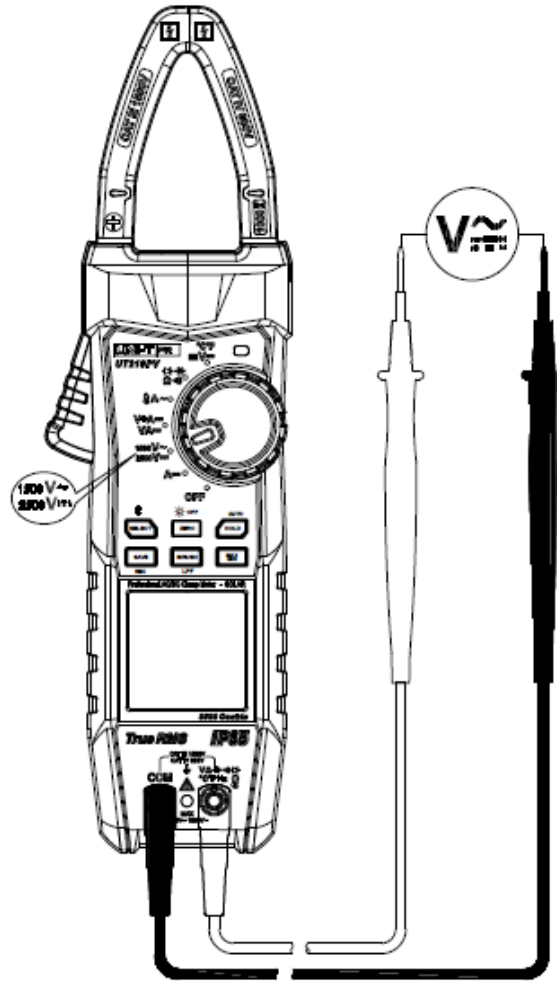
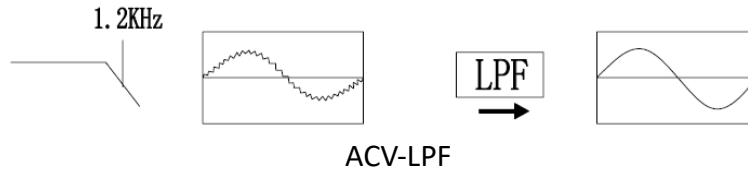

Figure 6

- 1) Connect the red test lead to “V” terminal and black to “COM”.
- 2) Set the rotary switch to “ $\frac{1500V}{2500V}$ ”, short press the SELECT button to switch to ACV or DCV function, then connect (in parallel) the test leads with the source or load to be measured.
- 3) Read the measurement result from the LCD.
- 4) Displayed measured AC voltage: True-RMS value
Sub-display: Frequency
- 5) To start the ACV-LPF function, please long press the INRUSH button when measuring ACV. In ACV-LPF function, the composite sine signal generated by the inverter and variable-frequency motor can be measured. As shown in the Figure below.



⚠ Warning:

- Do not input voltage over 2500V DC or 1500V AC. It is possible to measure higher voltage, but it may cause damage to the Clamp Meter.
- For high voltage measurement, please pay special attention to avoid electric shock.
- If the measured voltage is $\geq 30V$ (AC/DC), the high-voltage warning symbol “⚡” will be displayed. “OL” will appear on the LCD if the measured voltage is $>2510V$ DC and $<-2510V$ DC or $>1510V$ AC.
- If the DC voltage is less than $-10V$, the red backlight is lit up and the LED blinks for 10 seconds, the buzzer sounds for 10 seconds, and the symbol “POLARITY” blinks.
- If frequency is displayed on the sub-display, then the input amplitude shall be $\geq 5V$ rms for $20Hz \sim 100Hz$ and $\geq 10V$ rms for $100Hz \sim 1000Hz$.
- The low pass filter attenuates at $-3dB$ and the cutoff frequency is 1.2 KHz.

3. Measuring DC power and DC voltage/current (Figure 7)

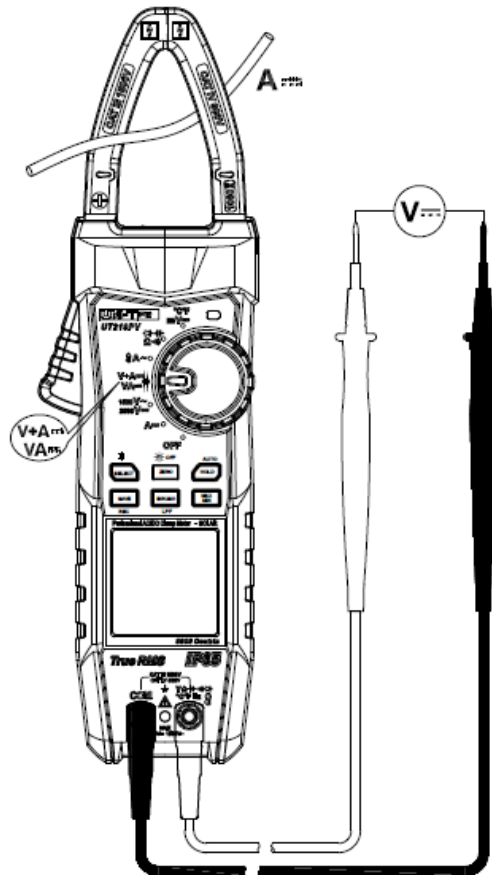

Figure 7

- 1) Connect the red test lead to “V” terminal and black to “COM”.
- 2) Set the rotary switch to “**V+A**”, short press the SELECT button to switch to VA or V+A function, connect (in parallel) the test leads with the source or load to be measured, press and hold the trigger to open the clamp jaws, clamp the conductor to be measured, then release the trigger slowly to close the clamp jaws completely.
- 3) Read the measurement result from the LCD (Main display: DC power or voltage; Sub-display: DC current).

⚠ Warning:

- Do not input voltage over 2500V DC. It is possible to measure higher voltage, but it may cause damage to the Clamp Meter.
- For high voltage measurement, please pay special attention to avoid electric shock.
- If the measured voltage is $\geq 30V$ (AC/DC), the high-voltage warning symbol “**⚡**” will be displayed. “OL” will appear on the LCD if the measured voltage is $>2510V$ DC and $<-2510V$ DC.
- The power range is switched using the voltage range.

4. AC current measurement (Clamp jaws and flex current sensor) (Figure 8 & Figure 9)

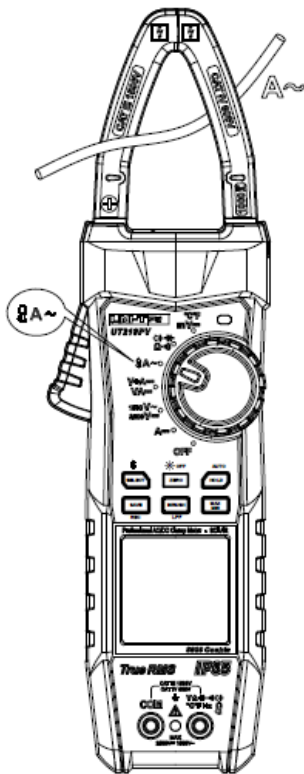

Figure 8

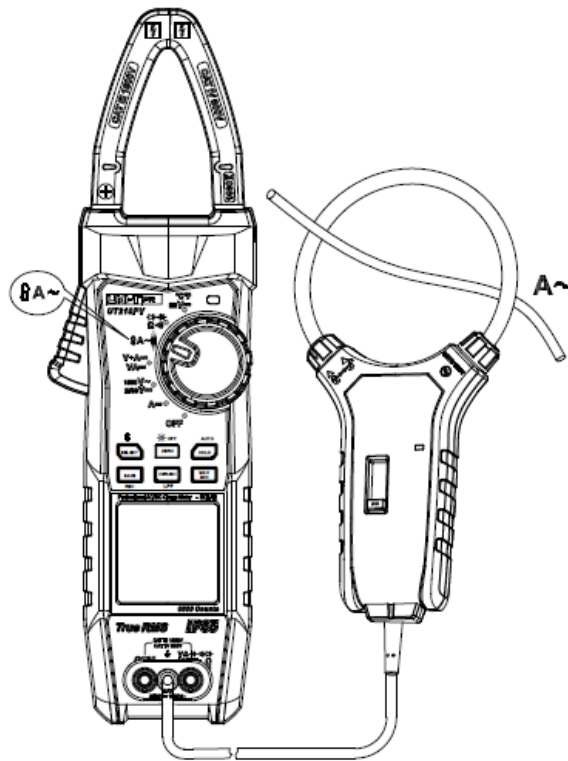

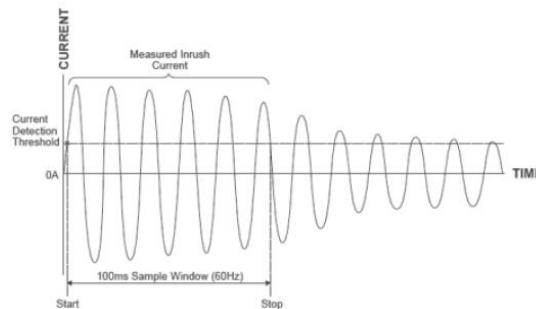
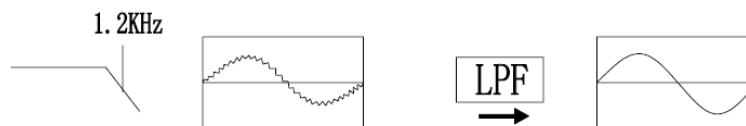

Figure 9

- 1) Set the rotary switch to “”. When the flex current sensor is connected, the Clamp Meter will automatically switch to corresponding measurement range, and “CS” and the symbol of corresponding range will be displayed.
- 2) Press and hold the trigger to open the clamp jaws, clamp the conductor to be measured, then release the trigger slowly to close the clamp jaws completely.
- 3) Read the measurement result from the LCD (Main display: True-RMS current; Sub-display: Frequency)
- 4) At ACA (clamp jaw)/flex current sensor measurement position, short press the INRUSH button to enter the AC inrush and peak measurement function. Instantaneous current at startup of electric appliances can be measured. The inrush current is the maximum current for an integral of 100 ms. Short press the INRUSH button again to exit the inrush and peak measurement function. As shown in the Figure below.



- 5) At ACA (clamp jaw)/flex current sensor measurement position, long press the INRUSH button to enter the ACA-LPF measurement function. The composite signal generated by the inverter or variable-frequency motor can be measured. Long press the INRUSH button again to exit the ACA-LPF measurement function. As shown in the Figure below.



ACA-LPF

Warning:

- Please measure one current conductor only at a time. Otherwise the measurement result will be incorrect.
- To ensure an accurate measurement result, please set the measured conductor at the center of the clamp jaws. Otherwise an additional error of $\pm 1.0\%$ will be produced.
- When monitoring the in-circuit frequency at AC current measurement position, the amplitude shall meet the requirements below:

5 Hz~10 Hz: ≥ 10 A

10 Hz~100 Hz: ≥ 5 A

100 Hz~999.9Hz: ≥ 10 A

- The error specified by the flex current sensor is the intrinsic error of UT219PV.

5. Resistance measurement (Figure 10)

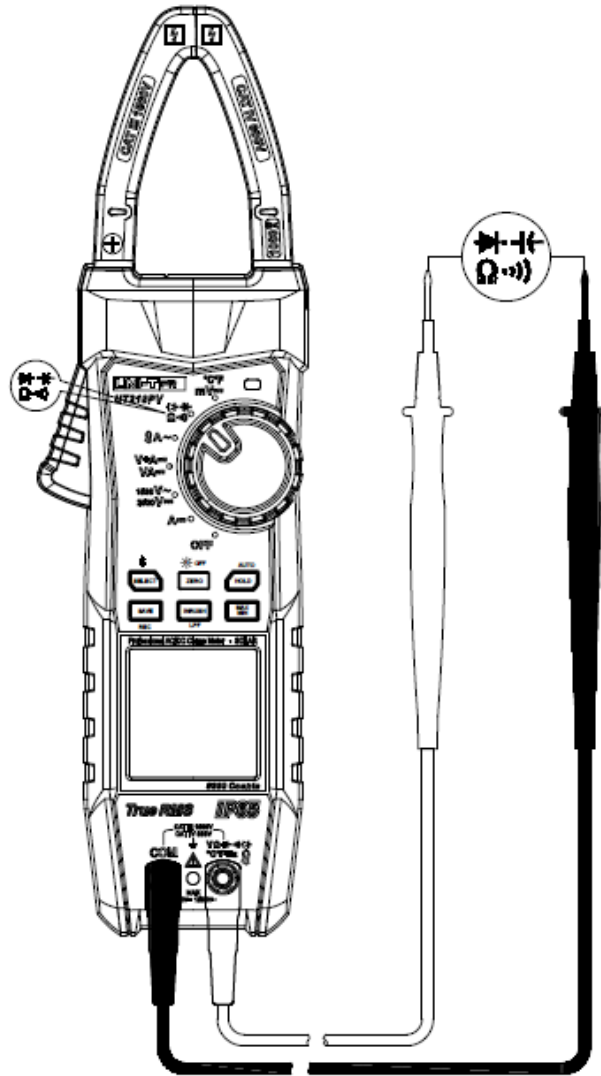



Figure 10

- 1) Connect the red test lead to “V” terminal and black to “COM”.
- 2) Set the rotary switch to “”, short press the SELECT button to switch to the resistance measurement position, then connect (in parallel) the test leads with both ends of the resistor to be measured.
- 3) Read the measurement result from the LCD.

⚠ Warning:

- For continuity test at 999.9Ω, fast response cannot be achieved. For resistance $\leq 30\Omega$, continuous sound is generated and green backlight is lit up. For resistance $\geq 50\Omega$, no sound is made.
- Before measuring in-circuit resistance, please switch off all powers of the measured circuit and discharge all capacitors thoroughly.
- If the resistance of shorted test lead is $\geq 0.5\Omega$, please check if the test lead is loose or other problems occur.
- Do not input voltage over 30 V DC/AC to avoid personal injury.

6. Diode measurement (Figure 10)

- 1) Connect the red test lead to “V” terminal and black to “COM”.
- 2) Set the rotary switch to , then short press the SELECT button to switch to the diode measurement position. The polarity of red test lead is “+” and black is “-”. Connect the red test lead to the positive pole of the measured diode and black to negative.
- 3) Read from the LCD the approximate forward voltage of PN junction of the measured diode. The normal voltage of silicone PN junction is about 0.5~0.8 V typically.

⚠ Warning:

- “OL” is displayed if the measured diode is open or the polarity is reversed.
- Before measuring in-circuit diode, please switch off all powers of the measured circuit and discharge all capacitors thoroughly.
- The open-circuit voltage for diode measurement is about 3.0 V.
- Do not input voltage over 30 V DC/AC to avoid personal injury.
- Please disconnect the test leads from the measured circuit after all measurement operations are completed.

7. Capacitance measurement (Figure 10)

- 1) Connect the red test lead to “V” terminal and black to “COM”.
- 2) Set the rotary switch to , short press the SELECT button to select the capacitance measurement position, then connect (in parallel) the test leads to both ends of the measured capacitor.
- 3) Read the measured capacitance from the LCD.

⚠ Warning:

- “OL” will be displayed if the measured capacitor is shorted or the capacitance exceeds the specified

maximum range.

- To avoid damage to the Clamp Meter and personal injury, please switch off all powers of the measured circuit and discharge all capacitors thoroughly before measurement, especially the capacitor with high voltage.
- Please disconnect the test leads from the measured circuit after all measurement operations are completed.

8. DC voltage (mV) measurement (Figure 11)

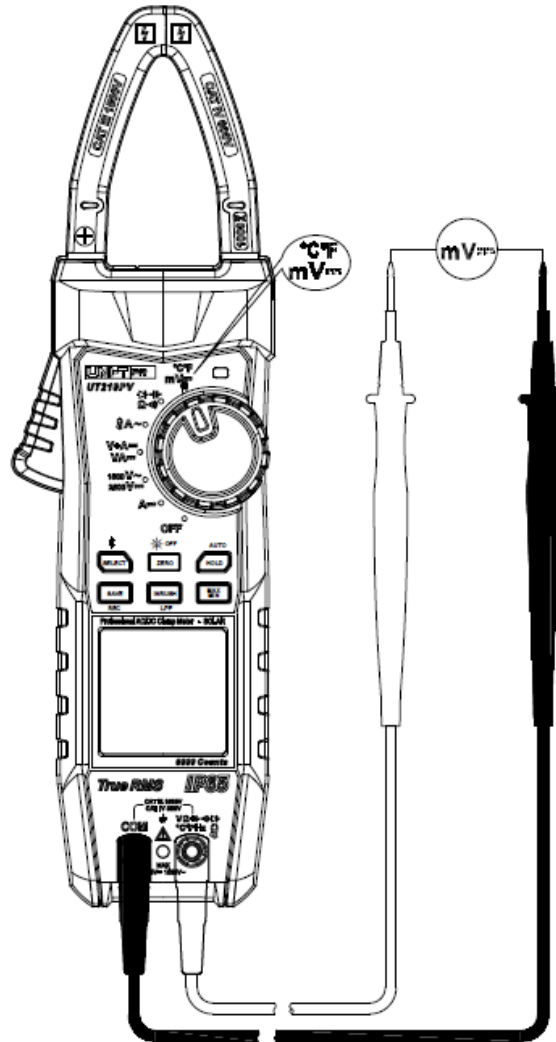

Figure 11

- 1) Connect the red test lead to “V” terminal and black to “COM”.
- 2) Set the rotary switch to “mV”, short press the SELECT button to switch to DCmV measurement mode, then connect (in parallel) the test leads with the source or load to be measured.
- 3) Read the measured voltage from the LCD.

Warning:

- The input impedance is about 10 MΩ for DC mV. Measurement error can be produced when measuring circuit with high impedance. The circuit impedance is below 10 kΩ in most cases, thus the error ($\leq 0.1\%$) is negligible.
- Do not measure input voltage over the range. Otherwise accurate measurement result cannot be obtained and damage to the Clamp Meter or personal injury may occur.
- Do not input voltage over 999.9 mV. It is possible to measure higher voltage, but the protection supplied by the Clamp Meter may be damaged.
- For high voltage measurement, please pay special attention to avoid electric shock.
- Please measure a known voltage before use to check if the product functions normal.
- The high-voltage warning symbol “⚡” appears on the LCD if the measured voltage is >999.9 mV DC or <-999.9 mV DC.
- Please disconnect the test leads from the measured circuit after all measurement operations are completed.

9. Temperature measurement (Figure 12)

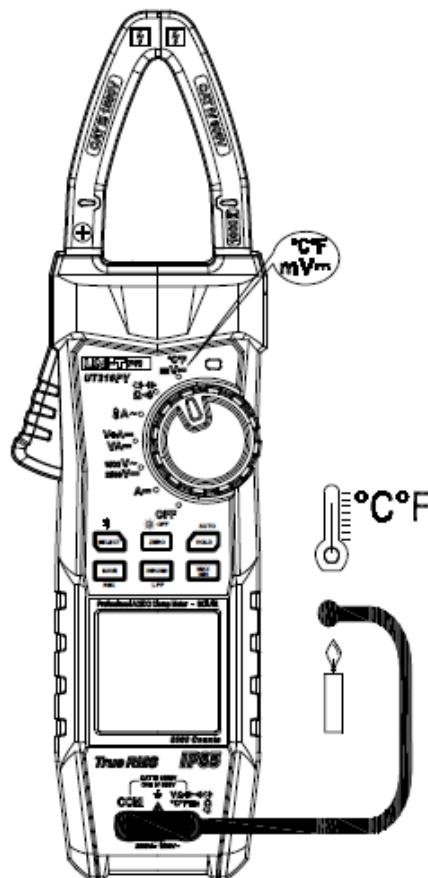

Figure 12

- 1) Connect the Type K thermocouple to the input terminal.
- 2) Set the rotary switch to “mV”, then short press the SELECT button to switch to the temperature



measurement mode.

- 3) Place the temperature probe at the surface of the object to be measured, then (a few seconds later) read from the LCD the temperature of the measured object.

 **Warning:**

- The ambient temperature shall be in the range of 18~28°C. Otherwise it will cause a measurement error. Obvious error can occur in low temperature.
- Do not input voltage over 30 V DC/AC to avoid personal injury.
- Please remove the temperature probe after all measurement operations are completed.

XII. Other Functions

- Long press the SELECT button to turn on/off the Bluetooth. If the Clamp Meter with the Bluetooth on fails to connect with the APP, the Bluetooth symbol on the LCD will blink. Open the “UNI-T Smart Measure” APP, search UT219PV, make connection, and then perform data communication, button control and other operations. The Bluetooth symbol on the LCD is displayed continuously with the connection established. If the Clamp Meter with the Bluetooth on fails to connect with the APP in 5 minutes or the data communication interrupts for more than 5 minutes after the connection is established, then the Bluetooth will be off automatically. The auto power off function will be disabled with the Bluetooth on.
- Auto power off: No operation for 15 minutes will turn off the Clamp Meter automatically (To power on the Clamp Meter, please turn the rotary switch from OFF position to any other position). To disable the auto power off function, please turn the rotary switch while pressing the SELECT button. The symbol “” will not appear on the LCD after the auto power off function is disabled. To enable the auto power off function, please restart the Clamp Meter.
- Buzzer: The buzzer sounds once with any enabled buttons pressed; and twice with disabled ones.
- Low voltage detection: If the supply voltage is $<2.2\pm 0.2\text{V}$ approximately, the symbol “” appears on the LCD. If $\leq 2.1\pm 0.2\text{V}$ approximately, the Clamp Meter powers off automatically.

XIII. Technical Specifications

Accuracy: \pm (a% of rdg. + b dgt.); guaranteed for 1 year

Ambient temperature and humidity: 23°C \pm 5°C; \leq 80% RH

Temperature coefficient: The temperature condition to ensure accuracy is 18°C~28°C. The fluctuation range of ambient temperature keeps within \pm 1°C. If the temperature is <18°C or >28°C, the additional error of temperature coefficient is "0.1 \times (specified accuracy)/°C"

1. DC current (DCA)

Range	Resolution	Accuracy	Overload protection
999.9A	0.1A	\pm (2.0%+5)	1000A AC/DC

* Press the ZERO button to zero the reading before measurement.

* Please perform measurement at the center of the clamp jaws. An error of 1% is added if deviated from the center.

* Accuracy guarantee range: 1~100% of range

2. DC voltage (DCV, DCmV)

Range	Resolution	Accuracy	Overload protection
999.9mV	0.1mV	\pm (1.0%+5)	1500V AC/DC
999.9V	0.1V		2500V DC/1500V AC
2500V	1V		

* Accuracy guarantee range: 1~100% of range

* Input impedance:

DCV: About 2 M Ω

DCmV: About 10 M Ω

3. AC voltage (ACV)

1). ACV

Range	Resolution	Accuracy	Overload protection
999.9V	0.1V	\pm (1.0%+5)	2500V DC/1500V AC
1500V	1V		

2). ACV-LPF

Range	Resolution	Accuracy	Overload protection
999.9V	0.1V	\pm (2.0%+9) (45Hz~100Hz)	2500V DC/1500V AC

* Input impedance: About 2 M Ω

* Frequency response (ACV): 40~1000 Hz (Display: True RMS)

* Accuracy guarantee range:

ACV: 1%~100% of range

ACV-LPF: 10%~100% of range

* Add an error for the AC crest factor of non-sine wave

- a) Add 3% for crest factor of 1~2
- b) Add 5% for crest factor of 2~2.5
- c) Add 7% for crest factor of 2.5~3

* If frequency is displayed on the sub-display, then the input amplitude shall meet the requirements below:

- 5 Hz~100 Hz: ≥ 5 V
- 100 Hz~999.9Hz: ≥ 10 V

4. DC power (VA)

1). VA

Range	Resolution	Accuracy	Overload protection
999.9KVA	0.1KVA	$\pm(2.0\%+20)$	2500V DC/1500V AC 1000A AC/DC
2500KVA	1KVA		

* Precision range: 5~100% of range

5. AC current (ACA)

1). ACA

Range	Resolution	Accuracy	Overload protection
999.9A	0.1A	$\pm(2.0\%+5)$ (40Hz~100Hz) $\pm(2.5\%+5)$ (100Hz~1000Hz)	1000A AC/DC

2). ACA_LPF

Range	Resolution	Accuracy	Overload protection
999.9A	0.1A	$\pm(2.5\%+9)$ (45Hz~100Hz)	1000A AC/DC

* RMS of sine wave

* Accuracy guarantee range:

- ACA: 1%~100% of range
- ACA_LPF: 10~100% of range

* AC crest factor (50/60HZ):

- 2.5 (At 600.0A)
- 3.0 (At 500.0A)
- 1.42 (At 999.9A)

Add an error for the crest factor of non-sine wave:

- a) Add 4% for crest factor of 1~2
- b) Add 5% for crest factor of 2~2.5
- c) Add 7% for crest factor of 2.5~3

* Please perform measurement at the center of the clamp jaws. An error of 1% is added if deviated from the center.

* If frequency is displayed on the sub-display, then the input amplitude shall meet the requirements below:

- 5 Hz~10 Hz: ≥ 10 A
- 10 Hz~100 Hz: ≥ 5 A
- 100 Hz~999.9Hz: ≥ 10 A

*3db frequency (ACA_LPF): About 1.2 KHz

6. Flex current sensor (CSA)

1). CSA

Range	Resolution	Accuracy	Overload protection
30.00A	0.01A	$\pm(3.0\%+5)$	2500V DC 1500V AC
300.0A	0.1A		
3000A	1A		

2). CSA_LPF

Range	Resolution	Accuracy	Overload protection
30.00A	0.01A	$\pm(4.0\%+9)$ (45Hz~100Hz)	2500V DC 1500V AC
300.0A	0.1A		
3000A	1A		

* Frequency response (CSA): 45Hz~500Hz (The frequency response refers to the intrinsic frequency response of UT219PV)

* 30.00A: 1A = 100mV (AC); 300.0A: 1A = 10mV (AC); 3000A: 1A = 1mV (AC).

* The specified accuracy at this measurement position is the intrinsic accuracy of UT219PV (eliminate the error of flex current sensor).

* CSA_LPF: 10~100% of range

* 3db frequency (CSA_LPF): About 1.2 KHz

7. Resistance (Ω)

Range	Resolution	Accuracy	Overload protection
999.9 Ω	0.1 Ω	$\pm(1.0\%+5)$	1500V AC/DC

9.999kΩ	0.001kΩ		
99.99kΩ	0.01kΩ		

* Precision range: 1~100% of range

*For continuity test at 999.9Ω, fast response cannot be achieved. For resistance ≤30Ω, continuous sound is generated and green backlight is lit up. For resistance ≥50Ω, no sound is made.

8. Diode

Range	Resolution	Overload protection
2.800V	0.001V	1500V AC/DC

* Open-circuit voltage: About 3 V

* Residual reading under short-circuit condition: ≤3 digits

9. Capacitance

Range	Resolution	Accuracy	Overload protection
100.0μF	0.1μF	±(1.0%+5)	1500V AC/DC
1000μF	1μF		

* Residual reading under open-circuit condition: ≤5 digits

* Measured value = Displayed value - Residual reading

* Precision range: 5~100% of range

10. Temperature

Range	Resolution	Accuracy	Overload protection
-40°C~400°C	0.1°C	±(1.0%+30)	1500V AC/DC
-40°F~752°F	0.2°F	±(1.0%+60)	

* Equipped with Type K (NiCr~NiSi) thermocouple

* Open-circuit indication: OL

* Short-circuit indication: Ambient temperature

* If each ambient temperature difference of the Clamp Meter reaches ±5°C, the accuracy can be adopted after 1 hour.

11. Table of Auto Hold Function

Table of Auto HOLD Function		
Function	Threshold	Fluctuation range/Increment
ACV	10V	2V
DCV	10V	2V
Ω	99.99KΩ	2.0Ω/20Ω/0.2KΩ

CAP	10 μ F	2 μ F
DCA	10A	2A
ACA (Clamp jaw)	10A	2A
CSA	1A/10A/100A	0.2A/2A/2A
VA	10KVA	2.0KVA

XIV. Bluetooth Software

1. Introduction

The Bluetooth software is a mobile APP and supports iOS 10.0 or newer and Android 5.0 or newer currently

2. Download iDMM2.0

① For Android

Method 1: Search "UNI-T Smart Measure" at "Google Play".

Method 2: Turn on the scanning function of "Google Play", then scan the QR code below.

② For IOS

Method 1: Search "UNI-T Smart Measure" at "App Store".

Method 2: Turn on the scanning function of mobile phone, then scan the QR code below.



For Android



For iOS

3. Use

3.1) Open the Bluetooth functions of both the Clamp Meter and mobile phone, tap the "UNI-T Smart Measure" APP icon on your phone desktop to open the software, then the software enters the navigation interface and searches nearby Bluetooth-enabled meters automatically. After that, select the corresponding meter and make connection. Alternatively, scan the QR code at the meter to make direct connection. In connected state, data communication, measurement result display, button control and other operations can be achieved.

3.2) The "UNI-T Smart Measure" APP has multiple functions including Bluetooth communication, data recording, device management, report generation, data sharing, data synchronizing, and more. For

the operating instructions about these functions, please refer to the “UNI-T Smart Measure” User Manual (In the APP, tap the menu button, “Setting” button, and then “Help Guide” button for the User Manual).

4. Uninstallation

Uninstall the software through the uninstallation function of mobile phone.

XV. Maintenance

⚠Warning: To avoid electric shock, please remove the test leads before opening the bottom cover.

1. If the Clamp Meter is not in use, please turn it off to avoid consuming battery power continuously.
2. General maintenance
 - a. The maintenance and service must be performed by qualified maintenance personnel or designated service center.
 - b. Please clean the case with dry cloth regularly. Do not use abrasives or solvents.
3. Battery replacement (Figure 13)

Power supply: AA 1.5 V battery × 2

Please follow the procedure below for battery installation/replacement.

 - a. Power off the Clamp Meter and remove the test lead from the input terminal.
 - b. With the front side of the Clamp Meter facing down, loosen the screws, remove the battery cover, take out the batteries, and then install new batteries (Do not reverse the battery polarity).
 - c. Install the battery cover and tighten the screws.

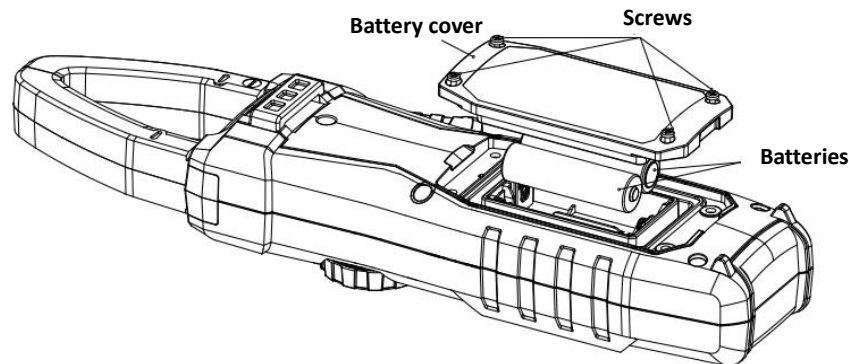

Figure 13

The contents in the User Manual are subject to change without further notice.

UNI-TREND TECHNOLOGY (CHINA) CO.,LTD.

No 6, Gong Ye Bei 1 st Road, Songshan Lake National High-Tech Industrial Development Zone,
Dongguan,
Guangdong Province, China