

Install Manual

(QPE-W222)

New S-class(W222)
New C-class(W205)

Warning / Caution



Warning

- When installing the main unit, do not remove or alter existing vehicle fasteners, including nuts, bolts, screw, clips, and fittings. Never detach, move or alter existing vehicle wiring, including electrical grounds and straps. Alteration of existing vehicle components may make vehicle unsafe to operate. Should be no any electronic devices or magnetic pole around installation place.
- Air bags are vital part of a safety system. Never install main unit in a way which will alter air bag wiring or interfere with air bag deployment. Air bags must function properly in the event of an accident.
- Before installing, check the location of pipe, tank, electrical cables and others.
- Read and follow the instruction manual.
- Wiring location must not interfere driving, get in or out from car.
- Use electrical tape to insulate the ends of all wires, even if they are not used. Proper insulation prevents arcs, shocks and fires.
- When installation is complete, test all vehicle electrical systems to ensure they operate correctly, including lights, horn, brake lights, and emergency flashers.
- According to our sales policy, any problems caused by user's mistake, careless can not be guaranteed.



Caution

- All steps of installation should be done by well-trained specialist.
- During installation ignition key should be taken off and after all installation finish connect power cable with interface for the last step.
- Do not install the main unit in places where it may be exposed to dew condensation (around the air conditioning hose, etc), or in locations where it may come in contact with water, high levels of moisture, dust or oily smoke
- Install wiring in a manner in which cables will not come in contact with metal parts. The wiring may be damaged by contact with metal parts, resulting in fire and shocks. Avoid all contact with hot surfaces when wiring the main unit. High temperatures may damage wiring, causing shorts, arcing and fires.
- Kindly check all parts are in the box, when receiving the product, if anything missing, inform to the supplier or manufacturer.

Table of Contents

1. Specifications	
1.1 Main Specifications	1
1.2 Features	2
1.3 System Diagram	3
1.4 Components	4
1.5 Exterior	6
2. Installation	
2.1 Installation Diagram	7
2.2 Cautions before Installation	8
2.3 Installation	9
3. Settings	
3.1 DIP Switch	17
3.2 Remote Control	18
3.3 Original Button using	19
3.4 FACTORY MENU	20
3.5 OSD	28
4. Trouble Shooting	30

1. Specifications

1.1 Main Specifications

1. Car Compatibility
New S-Class(W222), New C-Class(W205)
2. Components
Multimedia Interface* 1EA
Sub-Board *1EA
3. MULTIMEDIA INTERFACE input specification
3 * A/V input (video external input)
1 * CVBS(Rear Camera) input
1 * Analog RGB input (Navigation system, HDMI)
1 * LCD input (Car system input)
4. MULTIMEDIA INTERFACE output specification
1 * LCD output
1 * Audio output
2 * CVBS output
5. Power specification
Input power : 8VDC ~ 16VDC
Consumed power : 4WATT(Max)
6. Switch input mode
 - External display skip function
 - : Able to control each video input through DIP switch
 - Able to switch input modes through remote control
 - Able to switch input modes through Toggle switch
 - Able to switch input modes through original button

1. Specifications

1.2 Features

- Able to adjust external image (DVD, NAVI) display on screen
- Easy installation with Plug & Play type (Provide LVDS Cable)
- Improved Screen Display (user-oriented interface)
- Added SAFE function while driving
- Dynamic PAS(Parking assistance system) with PDC

1. Specification

1.3 System Diagram

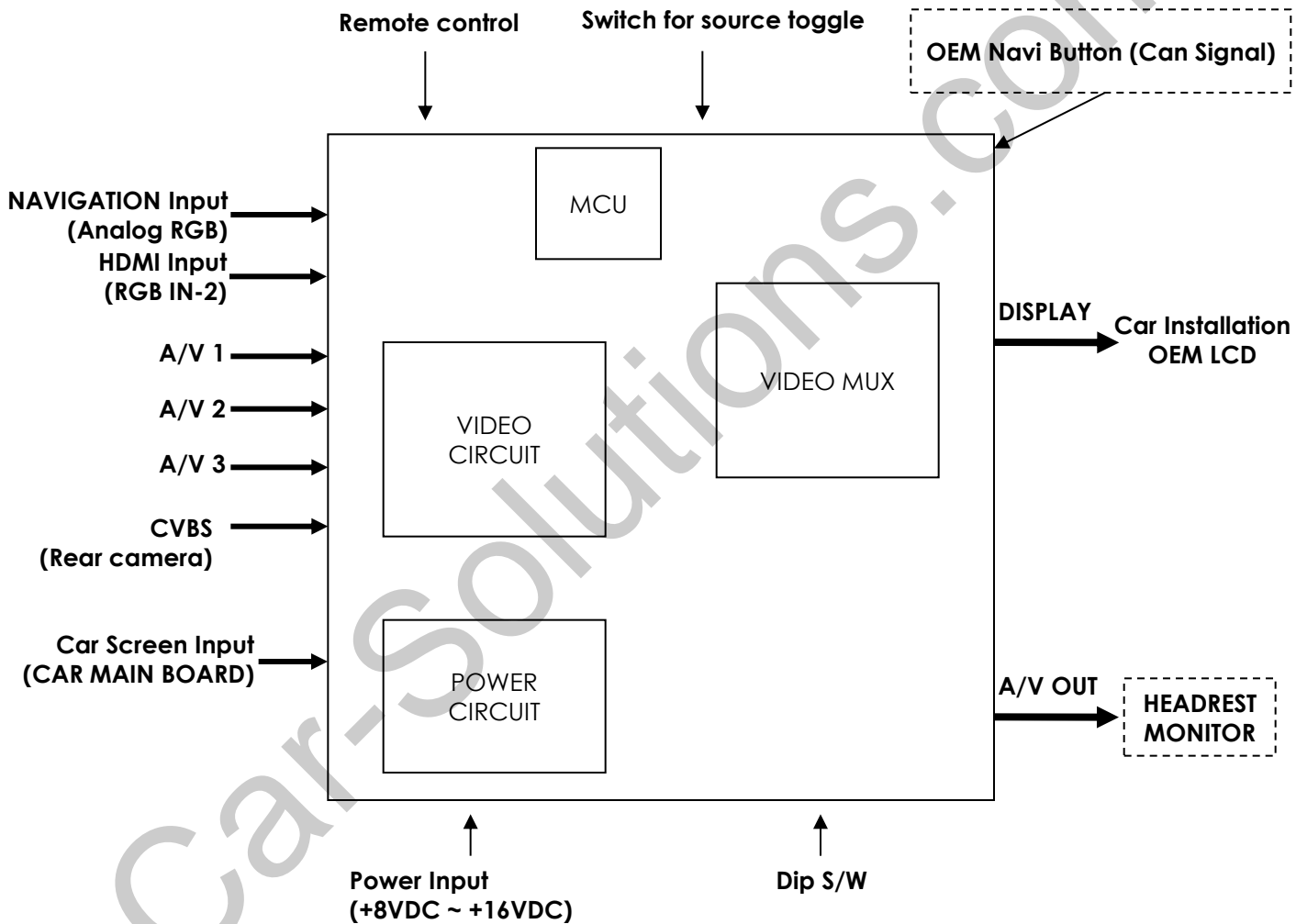

1. Specification

1.4 Components

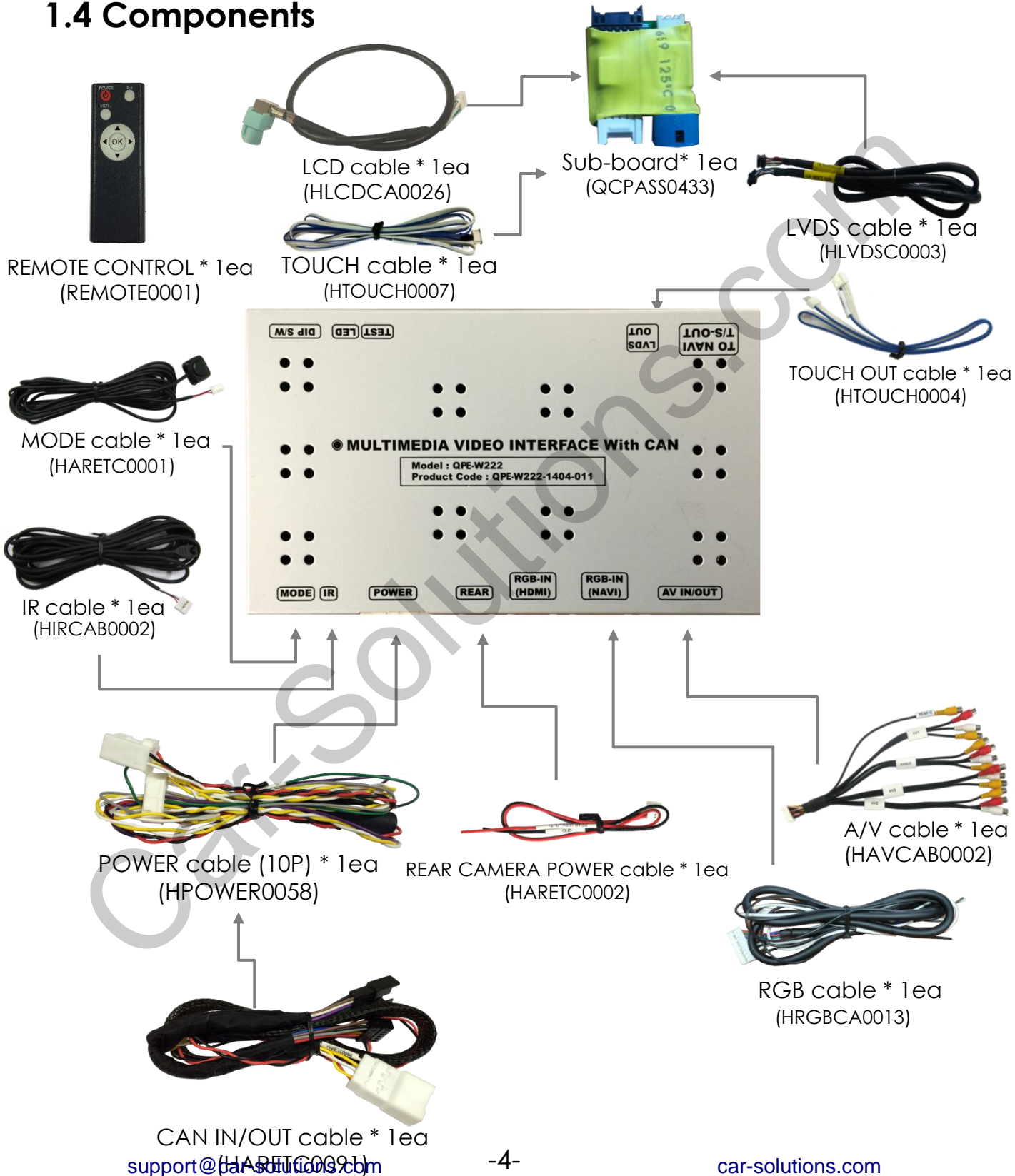

1. Specification

1.4 Components



12.3inch S-Class touch panel(Option)

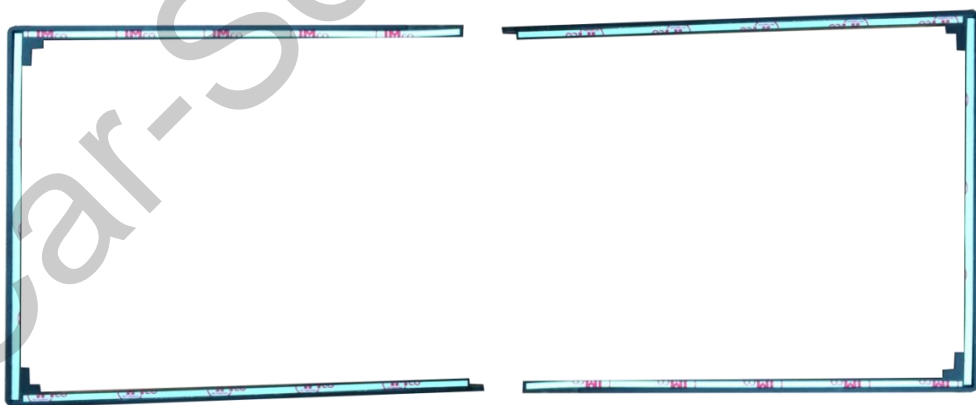

Plastic bracket for touch panel*2ea(Option)

2. Installation

2.1 Installation Diagram

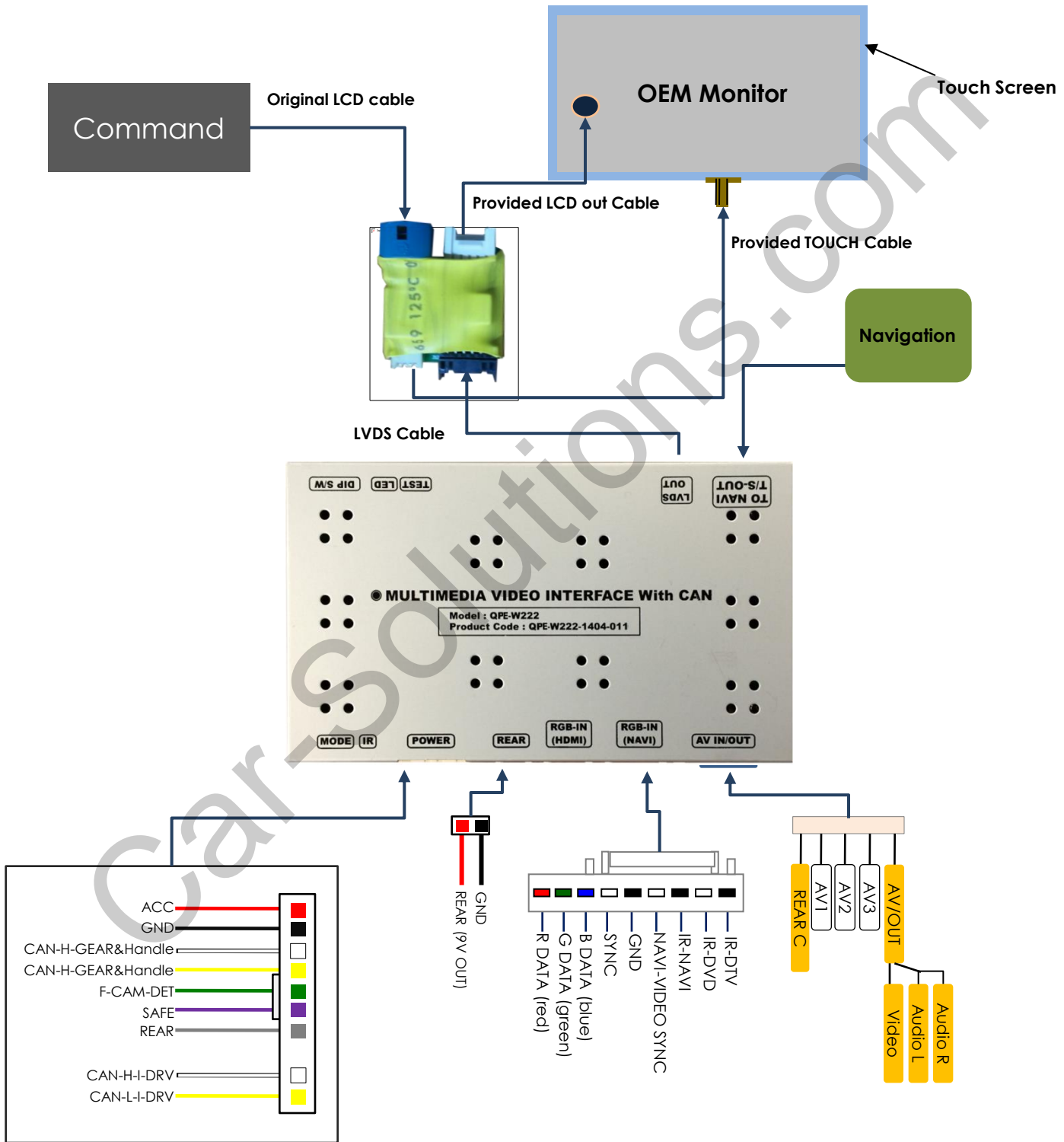

2. Installation

2.2 Cautions before installation

- Ignition key should be taken off before starting installation, interface power connection must be the last step in installation.
- Power cable should be separated when connecting interface.
- Should be no any electronic devices or magnetic pole around installation place.
- All steps of installation should be done by well-trained specialist.
- Dismantling without manufacturer's permission can not be guaranteed, (No permission to break attached label on the board.)
- Kindly check all parts are in the box, when receiving the product, if anything missing, inform to the supplier or manufacturer.
- According to our sales policy, any problems caused by user's mistake, careless can not be guaranteed.
- It may not work on a camera with 12V

2. Installation

2.3 Installation

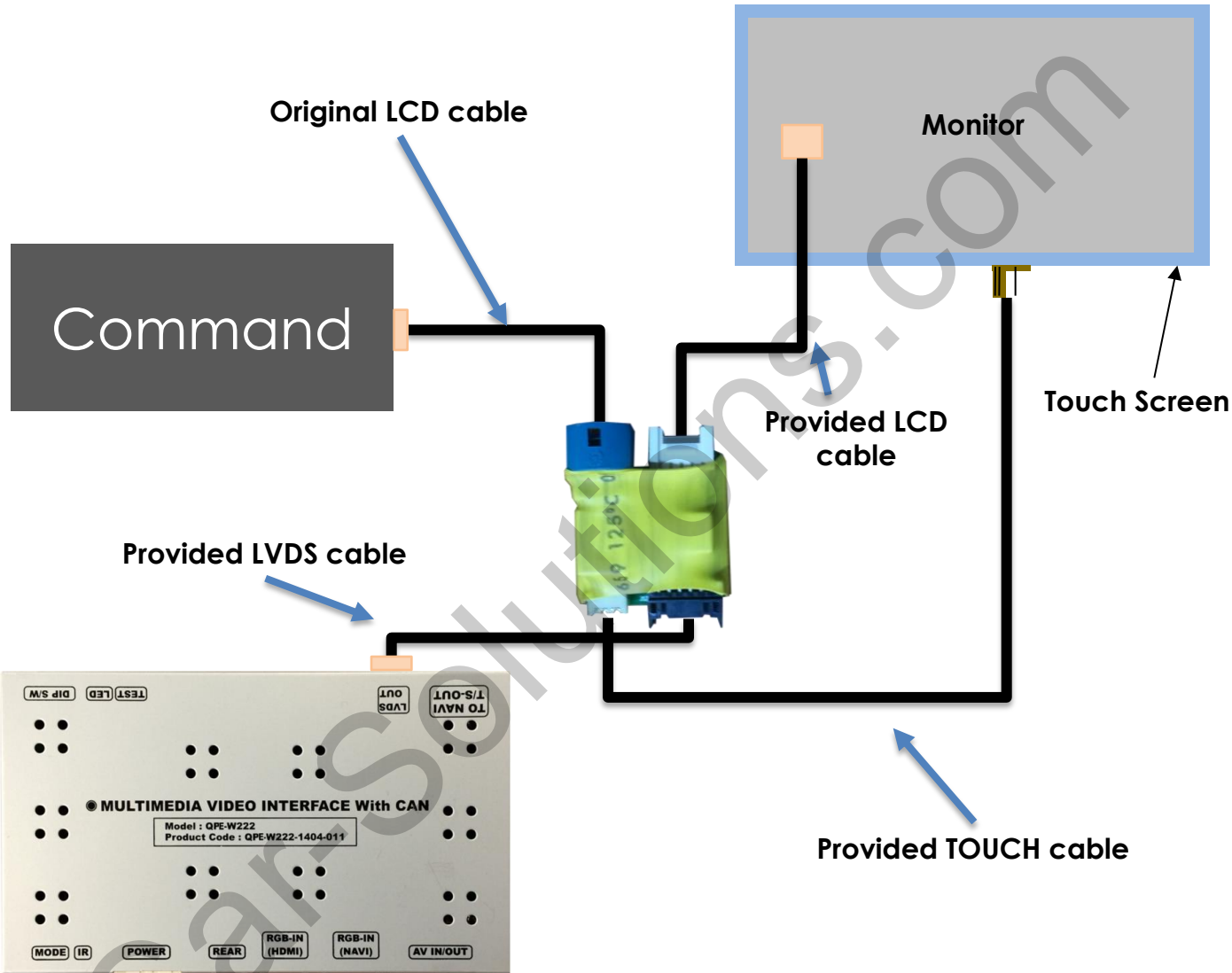

※ For using touch, have to buy touch screen

2. Installation

2.4 CAN Connection

※ First, Pull away a gear stick box and you will be able to see cables.

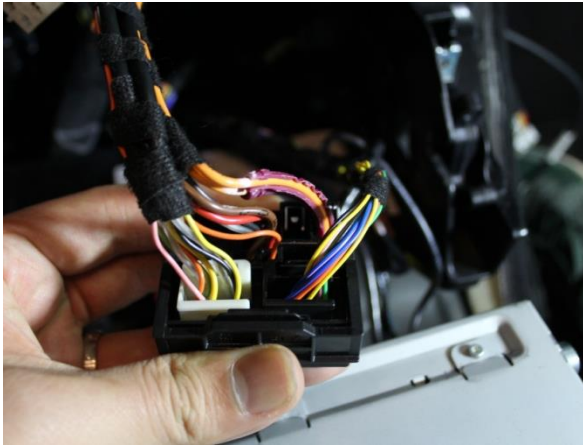

① Please find a bunch of cables as above picture.

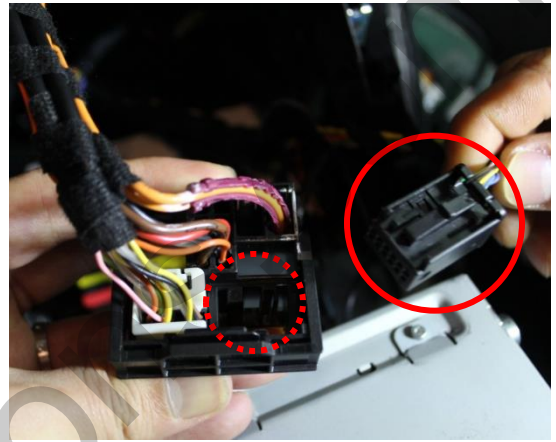

② Please take away the black connector marked in red.

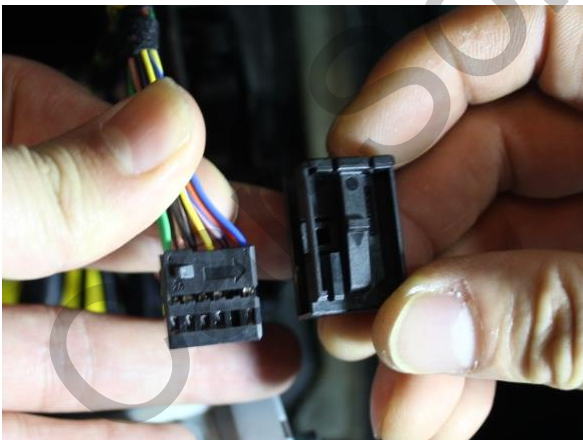

③ Please take away the black cap was pulled away.



④ Please connect the cable to offered CAN IN/OUT cables.

2. Installation

2.4 CAN Connection

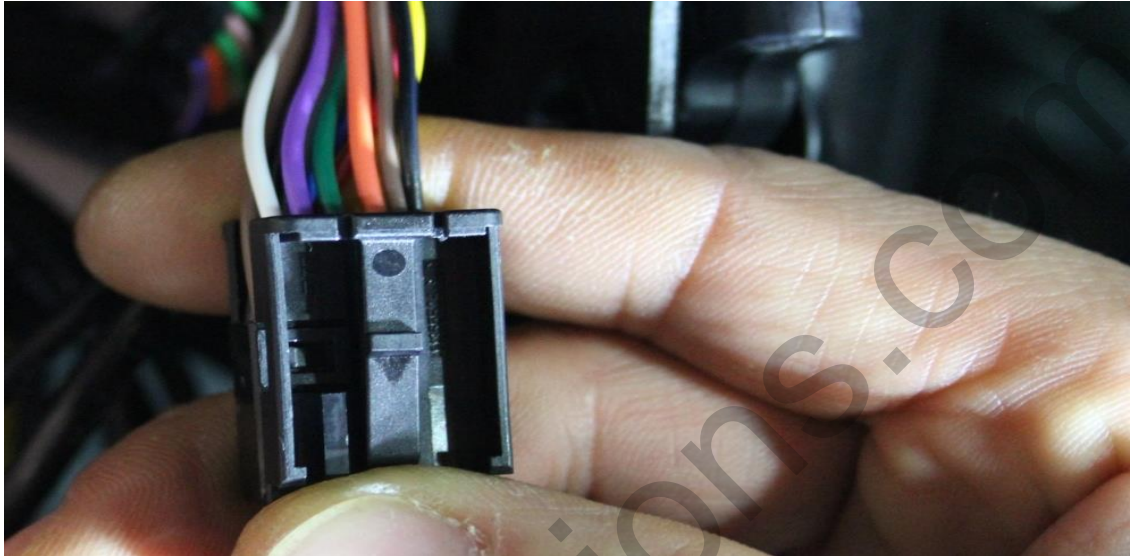

⑤ Please put CAN IN/OUT cables into the black cap

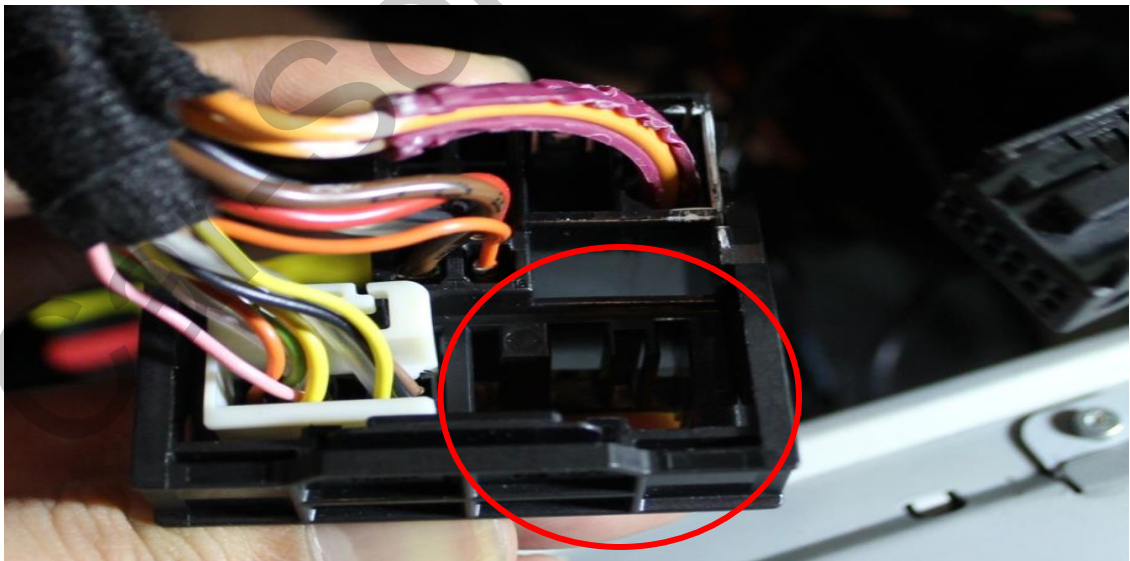

⑥ Please put it into the empty space where the black connector was pulled way.

2. Installation

2.4 CAN Connection

※ You will be able to find the CAN wire behind the Air conditioner.

Please cut the opposite side of offered power cable connector to use.

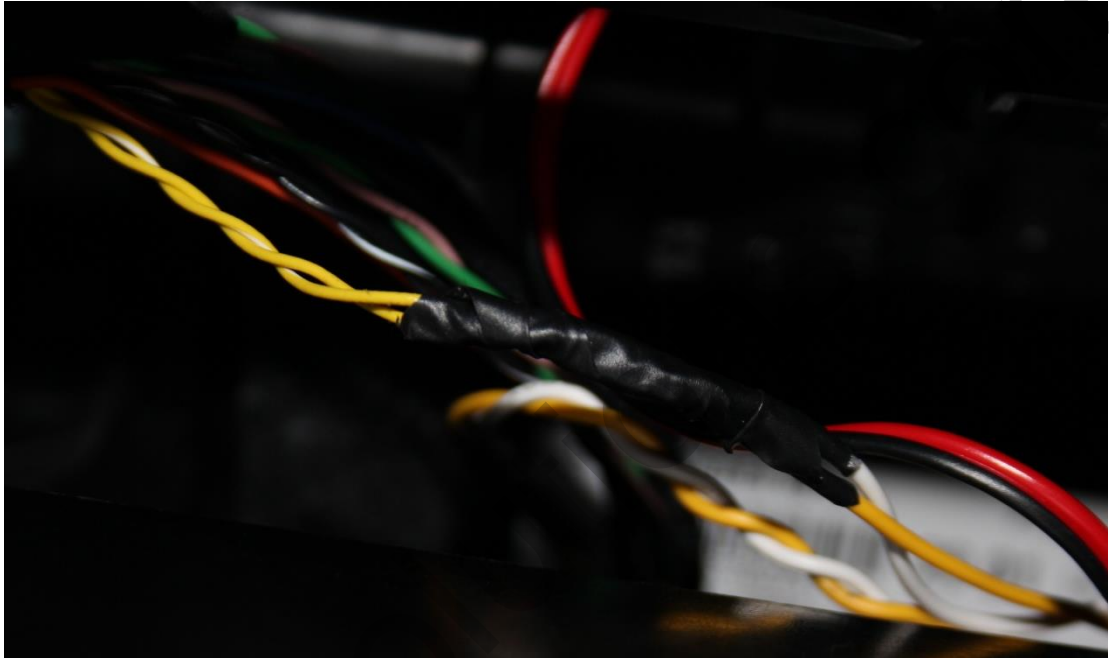

※ Please connect offered CAN-H-GEAR&HANDLE(White) to CAN-High(Yellow + White)

※ Please connect offered CAN-L-GEAR&HANDLE(Yellow) to CAN-Low(Yellow)

2. Installation

2.4 Installation of touch panel



2014 Year
Benz S-Class
Monitor.

There are some
spaces on the
edge of the
monitor.



This is supplied
frame with
double-side tape
attached.

2. Installation

2.4 Installation of touch panel



Put the supplied frame in the space.



Put them in both sides.

2. Installation

2.4 Installation of touch panel



2. Installation

2.4 Installation of touch panel



The height will be same as frame.



Take away the protection film of touch panel.

3. Settings

3.1 Dip Switch



※ ON : DOWN / OFF : UP

※ DIP S/W usage example
 - Input Mode : A/V1, Navigation (RGB)
 - Rear camera : When to be installed on CVBS 4

- ▷ DIP S/W : 1 → OFF
- ▷ DIP S/W : 2,3 → OFF
- ▷ DIP S/W : 4 → ON
- ▷ DIP S/W : 5 → ON
- ▷ DIP S/W : 6 → ON
- ▷ DIP S/W : 7 → ON (CVBS4)
- ▷ DIP S/W : 8 → ON

PIN	Function	Dip S/W Selection
1	RGB INPUT MUTE	ON : Skipping RGB Mode OFF : RGB Display
2	A/V 1 MUTE	ON : Skipping A/V 1 OFF : A/V1 Display
3	A/V 2 MUTE	ON : Skipping A/V 2 OFF : A/V2 Display
4	A/V 3 MUTE	ON : Skipping A/V 3 OFF : A/V3 Display
5	Select C-Class Monitor	ON : 800x480(7inch) OFF : 965x540(8.4inch)
6	Select Car model	ON : W222(S-Class) OFF : W205(C-Class)
7	Select Camera Type	ON : External Camera OFF : OEM Camera
8	Select Command type	ON : NTG 5.1 OFF : NTG 5.0

※ For using W222 Dual Screen type, Please set Dip #5, #6 to "On"

※ Please make sure to disconnect the power cable of the interface and reconnect the power cable again to apply the dip switch setting whenever changing DIP switch. Otherwise, DIP switch setting will not be applied.

3. Settings

3.2 Remote control



*FACTORY MODE (Interface setting for **installer**)
: Operated by pressing ▲ → ▼ → ▲ → MENU button or
press ◀ more than 5seconds long on the remote control.

Key	Function
POWER & PIP	Unavailable
MENU	Activating OSD menu
OK	Making a selection, changing image display
▲	Moving upward
▼	Moving downward
◀	Moving leftward (If you press this button 5 seconds long, you can get access to the factory mode.)
▶	Moving rightward (If you press this button 2 seconds long, you can reset all the data about user environment.)

3. Settings

3.3 Original button using

After wiring CAN of the car with offered CAN cable, you can switch A/V mode by the Factory button as below.

Long Press : Swtiching mode
Short Press : Original mode



IR REMOTE

↑↓ : Move Remote button
← : Select Remote button

<New S-Class Jog shuttle>

Long Press : Swtiching mode
Short Press : Original mode



IR REMOTE

↑↓ : Move Remote button
← : Select Remote button

<New C-Class Jog shuttle>

3. Settings

3.3.1 FACTORY MODE-IMAGE, PARK

FACTORY mode – Press ◀ button 2 seconds long on the remote control.

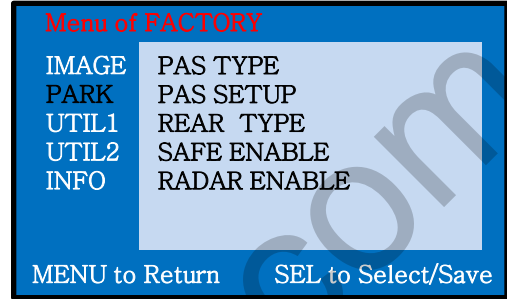
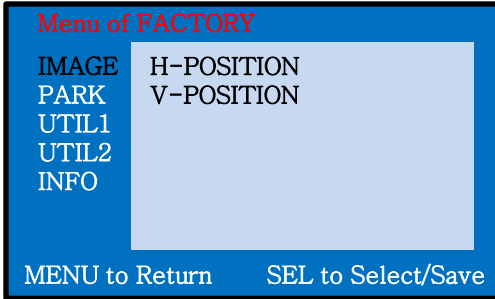

□ IMAGE

Adjust navigation position and size

H-POSITION : Move display horizontally

V-POSITION : Move display vertically

□ PARK

PAS TYPE : Selecting Type of parking guide line

- NOT USED : Not use Parking guide line

- PAS ON : Selecting Dynamic Parking guide line

- PAS OFF : Selecting fixed Parking guide line

PAS SETUP : Adjusting the position of the parking guide line

REAR TYPE : Choose rear camera recognition

* LAMP - Detecting the rear view camera via rear lamp (Installer must connect "Rear-C" cable of the power cable to the rear lamp of the car.)

*CAN - Detecting the rear view camera by CAN signal (Installer must connect "CAN" cable of the power cable to the "CAN" cable of the car.)

SAFE ENABLE : If your car is connected with CAN cable and it is in "ON" state, you can NOT watch DVD or A/V except original image or navigation while driving. At that time the screen get back to the main (default : OFF)

RADAR ENABLE : When set the gear to "R", Display PDC

3. Settings

3.3.1 FACTORY MODE-IMAGE, PARK

FACTORY mode – Press ◀ button 2 seconds long on the remote control.

Go to Factory Menu, choose PAS SETUP, by using OK button change H-POS → V-POS

□ H-POS



In H-POSITION, use ◀, ▶ on remote control, to adjust parking guideline left and right.

□ V-POS



In V-POSITION use ▲, ▼ on remote control, to adjust parking guideline up and down.

3. Settings

3.3.2 FACTORY MODE-UTIL1

FACTORY mode – Press ◀ button 2 seconds long on the remote control.

▪ Setup for navigation

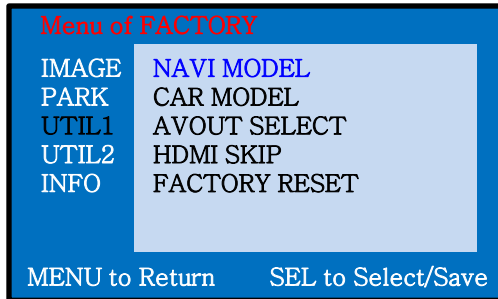

▪ Setup for car model

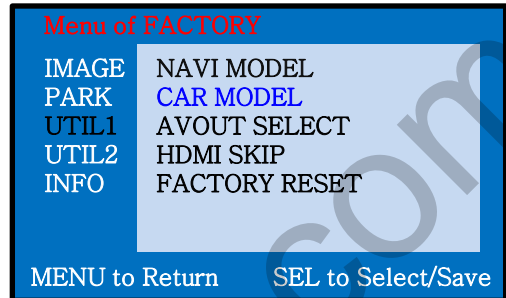

UTIL1 – NAVI MODEL

Definition of the navigation resolution

DEAFULT
NAV-506TP
MYVI
WP9200
HDMI
GI-8000N 3D
GI-5000A
I-ONE
KD-900
PAPAGO
LS-901

UTIL1 - CAR MODEL

Selecting the model of the car

Dip S/W #8 - ON

NTG5.1 B-Class
NTG5.1 CLS

Dip S/W #8 - OFF

NTG5.0(EXT REAR)
NTG5.0(OEM REAR)

*** Go into FACTORY/ IMAGE (as shown right) and adjust the position and the size of the navigation after setting the definition of the navigation**

3. Settings

3.3.2 FACTORY MODE-UTIL1

FACTORY mode – Press ◀ button 2 seconds long on the remote control.

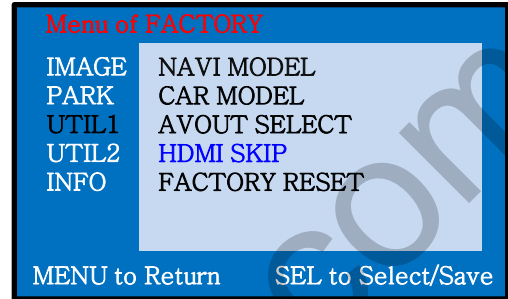
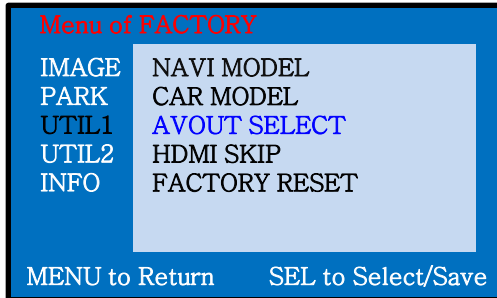

UTIL1 – AVOUT SELECT

Selecting background sound
After switching to navigation
or original mode

DEFAULT : Set up to keep
playing previous AV sound
when switching away from AV
mode to navigation or original
mode

AV 1~3 : Sound of the selected
AV source 1~3

UTIL1 – HDMI SKIP

Selecting whether to use
HDMI function or not

ON(Not use) / OFF(use)



UTIL1 - FACTORY RESET

FACTORY MODE RESET

3. Settings

3.3.3 FACTORY MODE-UTIL2

FACTORY mode – Press ◀ button 2 seconds long on the remote control.

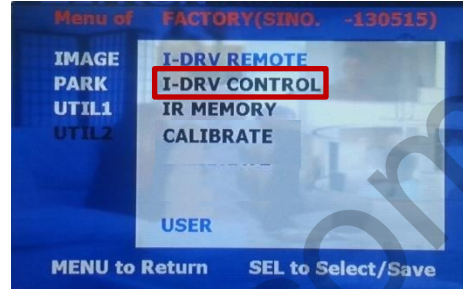
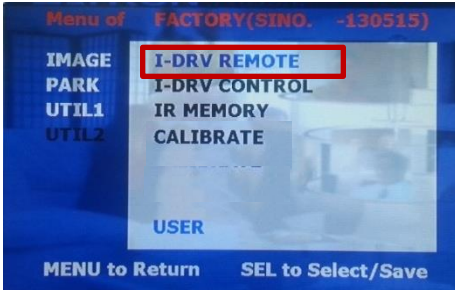

UTIL2 - I_DRV REMOTE

Choose DTV and DVD model to control screen touch(thru Remote control UI)

LI-1DISC

NEC-6DISC

USER(when using IR MEMORY)

•Select DVD model: Setting on AV1 Mode

•Select DTV model : Setting on A/V2 mode

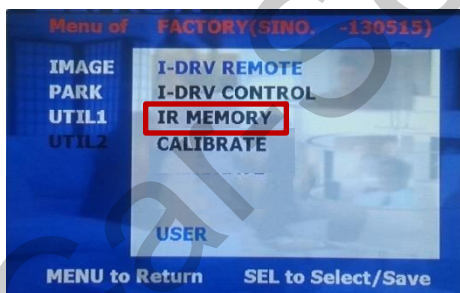

UTIL2 – IR MEMORY

To register DVD, DTV remote control, the remote control value must be registered and can be control with touch function DVD(A/V1), DTV(A/V2), DVD / DTV

※ To use this function, in UTIL2-I_DRV REMOTE select USER mode

UTIL2 - I_DRV CONTROL

Selecting whether to use touch function or not

ON / OFF

A/V1 : Control DVD Remote control UI

A/V2 : Control DTV Remote control UI

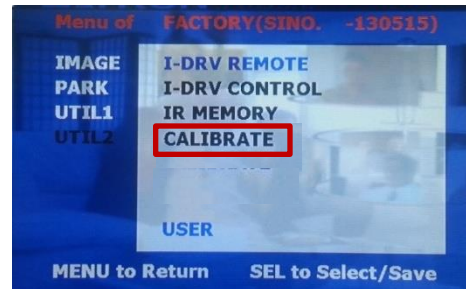

UTIL2 – CALIBRATE

Touch Calibration

YES / NO

3. Settings

3.3.3 FACTORY MODE-UTIL2

FACTORY mode – Press ◀ button 2 seconds long on the remote control.

□ UTIL2 – IR MEMORY

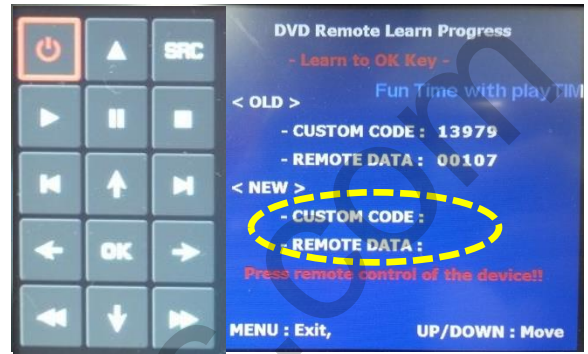

- ① First of all, press ◀ button on remote controller 2 seconds long or press UP→DOWN→UP→MENU button in order to access Factory mode. Choose IR MEMORY on UTIL2.

In IR MEMORY, you can choose AV source of DTV and DVD you want to use.

- ② Picture above shows DVD remote control button value input, select menu you want to save. (To register DVD remote control button value, select IR MEMORY – DTV and follow below instructions.

Example)

- a. After select OK button on OSD menu, press intended I-Drive button
- b. Indicated part above will flicker, and press POWER on DVD remote control.
(continue to next page)

What is IR-MEMORY Mode?

Is to allow touch screen to control other DVD or DTV (besides the existing,; for example : SANYO, NECVOX) by register remote control value.

3. Settings

3.3.3 FACTORY MODE-UTIL2

FACTORY mode – Press ◀ button 2 seconds long on the remote control.

□ UTIL2 – IR MEMORY



Instruction> continued...

c. The values that you registered will appear as green text in the marked area on pressing the button. And the values will be saved automatically.

d. Register remain buttons' value in OSD menu like the above-mentioned.

- ③ After register, select "SRC" button in OSD menu. Then you can see confirmation window as shown above. At the moment, (If data is saved, DVD TYPE and DTV TYPE will be changed to "USER" automatically.)

If you see "SUCCESS" on screen, the data is saved clearly and you can control DVD via touch screen. BUT, you MUST change the option in FACTORY-UTIL2-I_DRV REMOTE to "USER".

- ※ When touch the screen or Select PIP button in remote controller, you can control DVD, DTV using remote control UI via touch screen
- ※ DVD(A/V1), DTV(A/V2) mode, Can see remote control UI
- HDMI, A/V3 mode, Can see mode switching UI
- If you want to see mode switching UI in DVD, DTV mode, Select "SRC" button

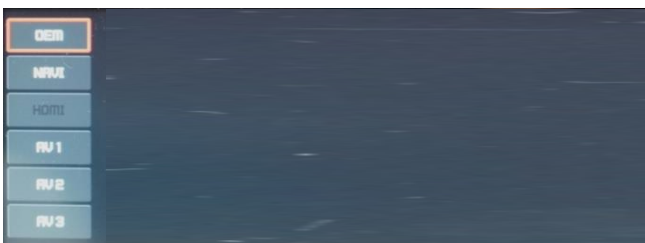

3. Settings

3.3.3 FACTORY MODE-INFO

FACTORY mode – Press ◀ button 2 seconds long on the remote control.

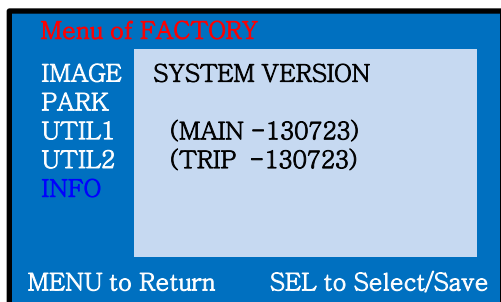

INFO

Check main version and Trip version

3. Settings

3.5 OSD (On Screen Display) / Analog RGB Mode



□ IMAGE

- * BRIGHTNESS
- * CONTRAST
- * SHARPNESS

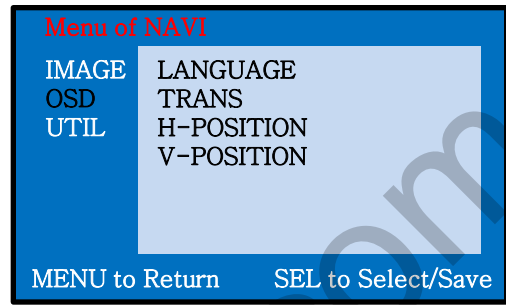

□ OSD

- *LANGUAGE : Set OSD language (only support English and Chinese)
- * TRANS : Adjust OSD transparency
- *H-POSITION : Move OSD horizontally
- * V-POSITION : Move OSD vertically



□ UTIL

- * FACTORY RESET
: Factory reset only for OSD function (unable reset video position)

3. Settings

3.5 OSD (On Screen Display) / Video Mode



□ IMAGE

- * BRIGHTNESS
- * CONTRAST
- * SATURATION
- * HUE
- * SHARPNESS

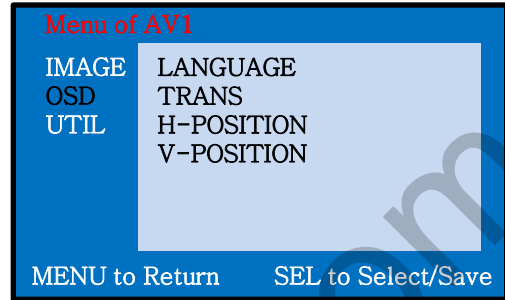

□ OSD

- * LANGUAGE : Set OSD language (only support English and Chinese)
- * TRANS : Adjust OSD transparency
- * H_POSITION : Move OSD horizontally
- * V_POSITION : Move OSD vertically



□ UTIL

- * FACTORY RESET
: Factory reset only for OSD function (unable reset video position)

4. Trouble Shooting

Q. I cannot change mode

A. Check connection of Ground cable and IR Cable.
Check LED lamp is on, if not check connection of POWER cable.

Q. All I got on the screen is black.

A. .Check second LED lamp of the interface is on, if not, check A/V sources connected are working well.
(Second lamp indicates AV sources connected works well.) Check interface connection has been done well.

Q. Displayed image color is not proper (too dark or unsuitable color)

A. Try to select "INITIAL" in OSD menu, if it does not work, inform to manufacturer.

Q. I cannot watch the rear camera on the screen

A. Set the DIP switch #7 as state "ON".

Q. Set mode not appear

A. Check DIP Switch.

Q. OEM image is not displayed.

A. Check interface's LCD In/Out cable connection. If the status keeps on, inform to manufacturer.

Q. Screen only displays white color.

A. Check LCD out cable is connected well, if this status keeps, inform to manufacturer.