

Camera Adapter with CarPlay
for Mercedes-Benz with NTG5.0/5.1 System

The Manual

Car-Solutions.com

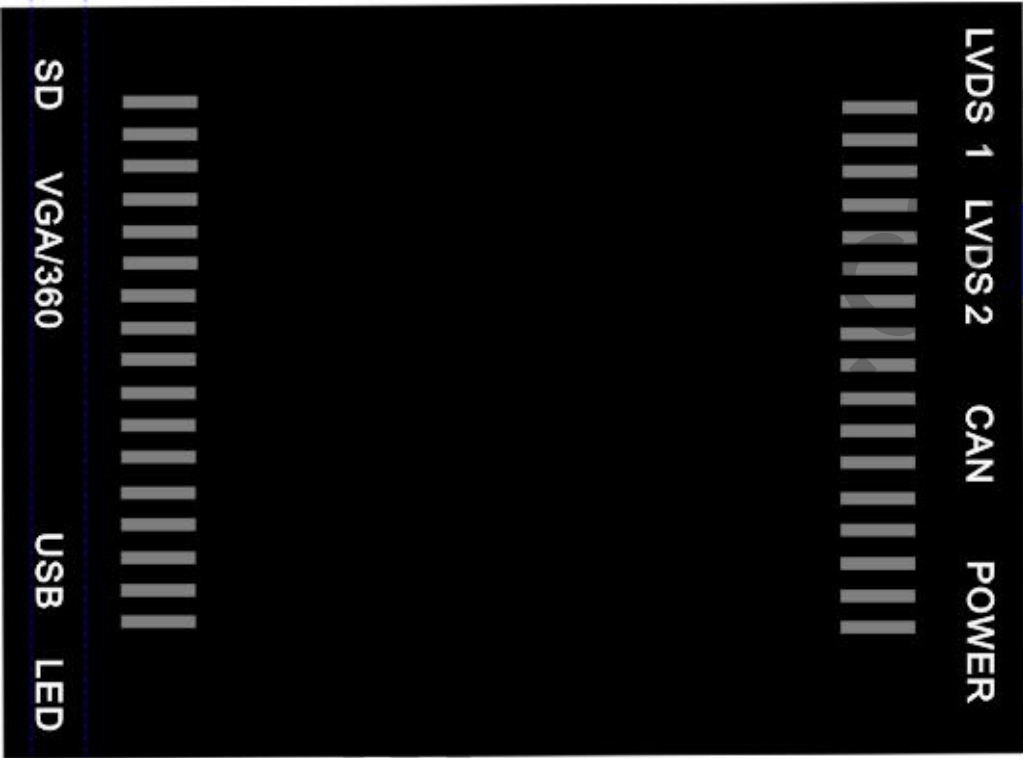

Car-Sol

Catalog

1. Packing Lists.....	3
2. Wiring Diagram.....	4
3. The description of dip switcher.....	5
4. Operation Instructions.....	6
5. Safety Considerations.....	12

Car-Solutions.com

1. Content

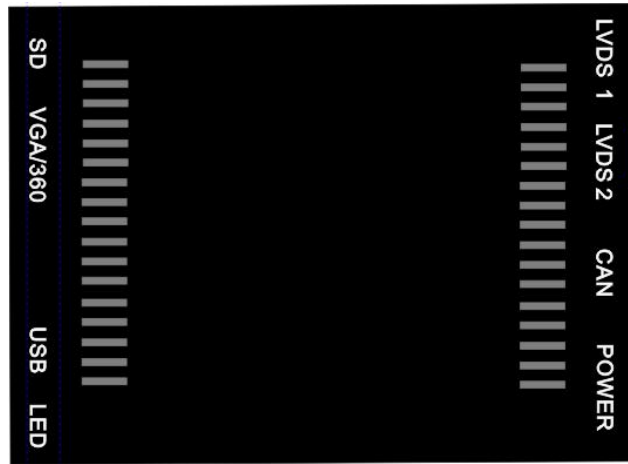

Video Interface



Power Wires



LVDS Cables



Audio&Video Cables

2. Wiring Diagram

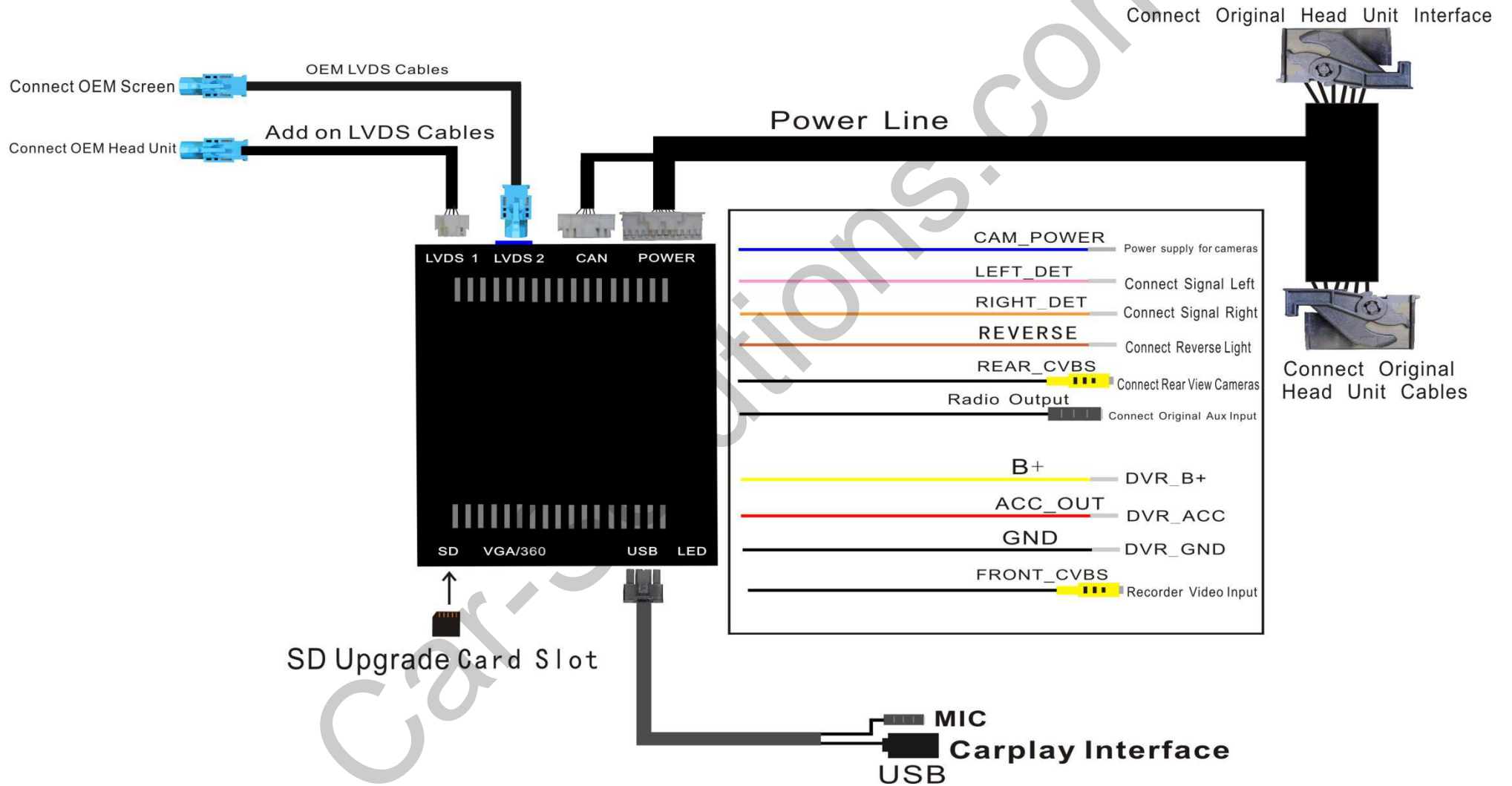

3.1 The description of dip switch



1	OFF	IPAS ON	5	OFF	960X480 8.4"
	ON	IPAS OFF		ON	800X480 7.4"/8.4"
2	OFF	360 ON	6	OFF	2015 C new/GLC
	ON	360 OFF		ON	2015 A new/B new /CLA/GLA/CLS/GLS/GLE/E new
3	OFF	VGA	7	OFF	Add on Rear camera
	ON	CVBS		ON	OEM Rear camera
4	OFF	RESERVED	8	OFF	OEM microphone
	ON	RESERVED		ON	Add on microphone

4. Operation Instructions

4.1 Switching Operation

1. After installing the video interface correctly, long press the Return Key of steering wheel or Voice button enter into the interface menu



Long press the Return Key of steering wheel



Add on Interface

4.2.1 Carplay Function

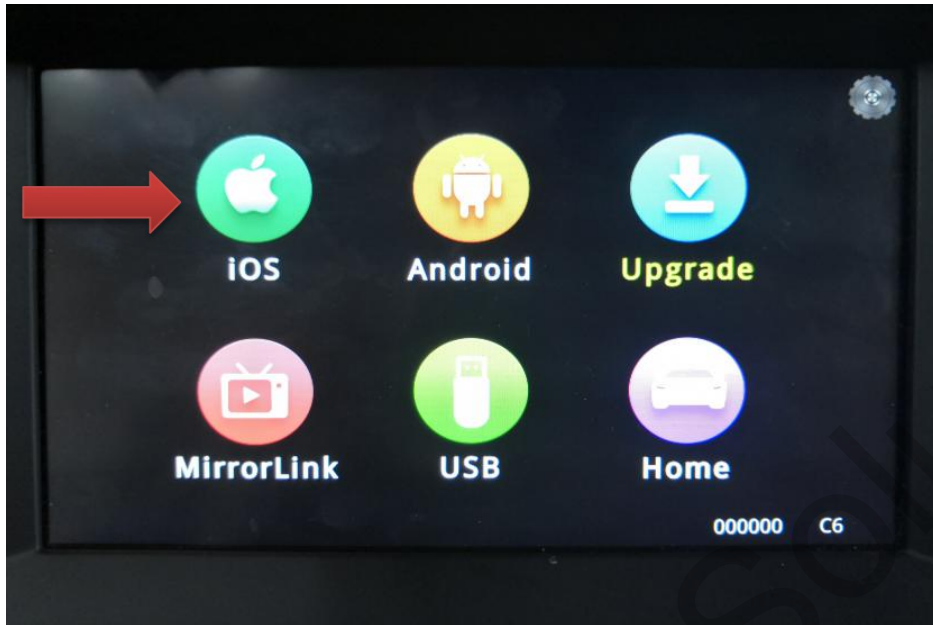

1. Connect Carplay with mobile, open the CARPLAY function.

2. Waiting connection, after connect successfully then to use

4.2.1 Android auto Need download Android auto APP in the Google Store

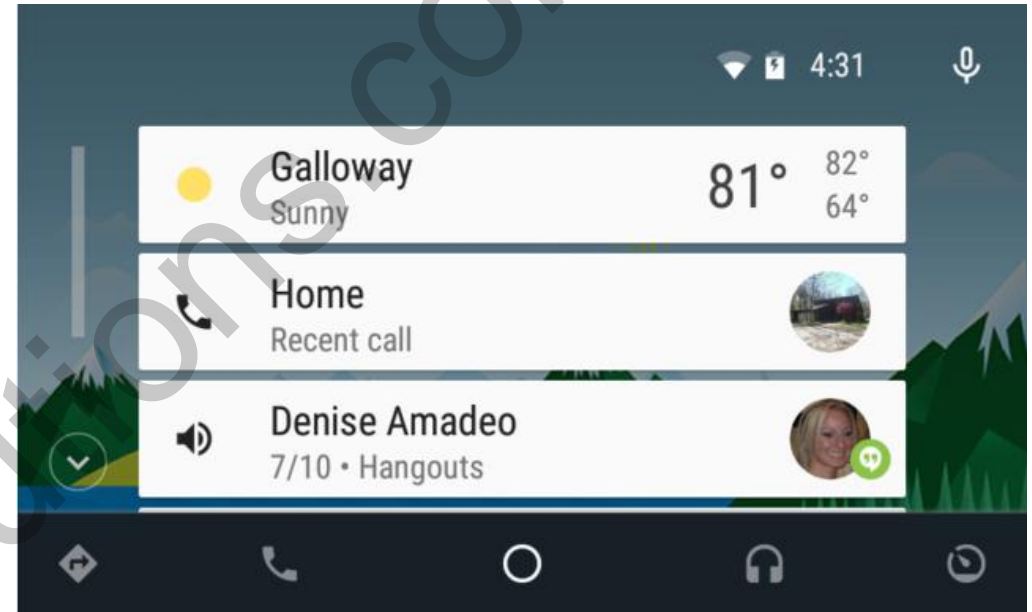
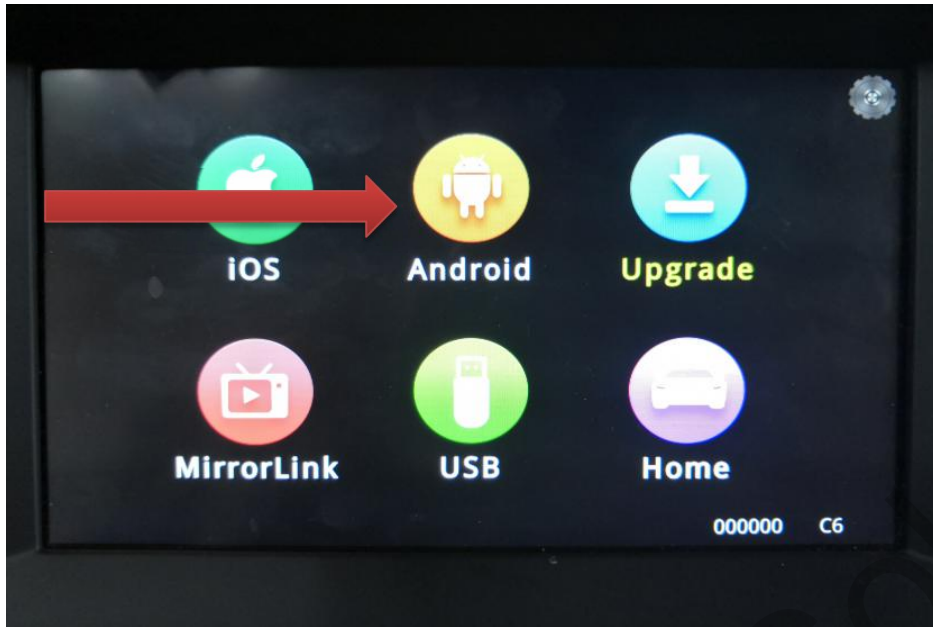

1. After connection with mobile, enter into Android auto function, waiting for connection.

2. After connect successfully, then it can be used. Android auto can set up to OK Google voice wake-up in Google, then voice operation function can be used.

4.2.3 Mirrorlink Function the following demo mobile phone is IPHONE.

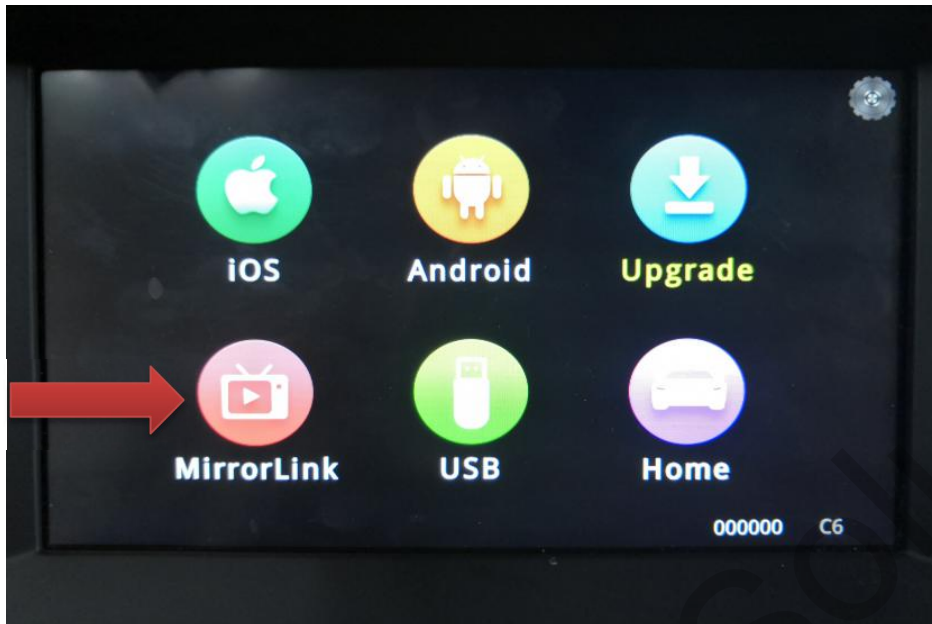

1. Mobile phone connect Carplay interface, enter into MirrorLink function.

2. Waiting for connection, after connect MirrorLink successfully then use.

4.2.4 USB Function

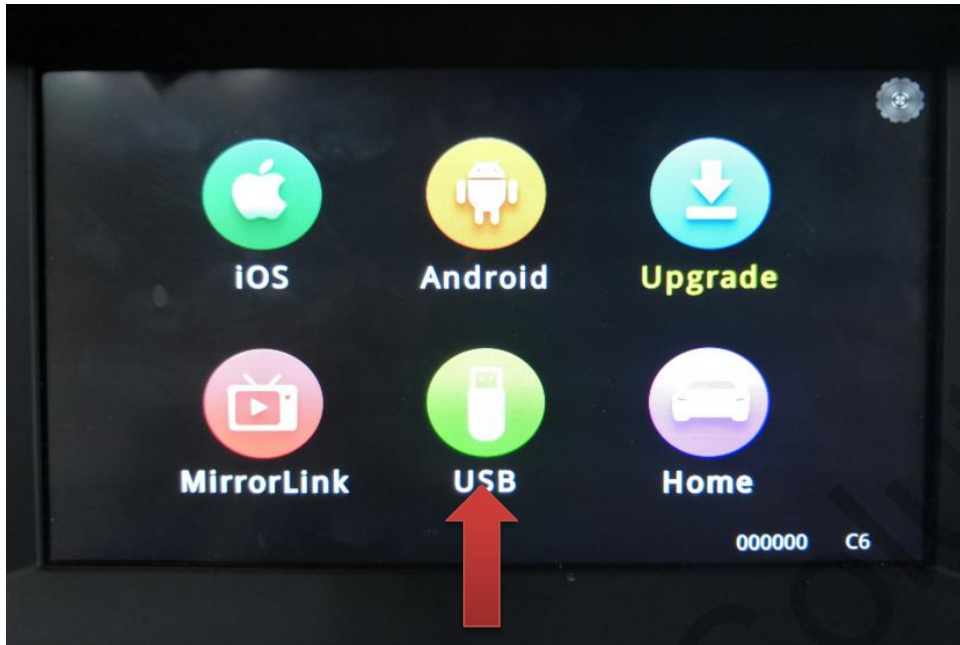

1.USB insert Carplay interface,enter USB function.



2.After entering, video and picture of USB can be read.

4.4 Other function description



1. Rear View



2. DVR: After connect cables correctly, the switch order will become long press the Return Key of steering wheel or voice button, Vehicle -Carplay-DVR and so on.

5. Safety Considerations

- 1. In order to protect driving safety and avoid break the traffic law,pls do not watch the program or use this product when you're driving.**
- 2. Pls do not put the product in the damp environment or water,in order to avoid electric shock damaged and fire accident caused by short circuit.**
- 3. The reversing surveillance function just be used in reversing assistance.Once happened reversing accident does not concern us.And hint of fault message need to be confirmed by professional maintenance Center.**
- 4. In order to safety and ensure the use of product, the installation pls leave it to the professional.Do not unload by yourself in order to avoid caused damaged or accident.**
- 5. Start the engine before loading,check the interface whether have function displayed,key control whether correct,the vehicle interface wether have scratch.Pls give the feedback to customers if there has any questions.**
- 6. Pls note that put the disassemble automotive components in a good way on the installation process,avoid scratching the instrument panel,the leftovers of connect cables need to handle and do not leave it in the car.The connecting plug must be insulated in order to short circuit.**

- 7. The cables should be connected in a good way, the vehicle installation space is a little small, so reduce space usage as far as possible, and it will be easy installation for monitor. There should be a good plan about connecting cables, avoid affecting the active component of connecting, such as control components of turning steering wheel, throttle and brake pedal. There need to be fasten after connecting cables in case of drop.**
- 8. Pls do not plug or pull the connected cables in the state of power-on, in order to avoid damaged monitor or accessory.**

Car-Solutions.com