

Car Video Interface for Audi A3 / Volkswagen Golf 7

User Guide

Update Date	2013.11.13
Model	QPI-A3-MAIN V2.0
Firmware Code	131022

Warning / Caution



Warning

- When installing the main unit, do not remove or alter existing vehicle fasteners, including nuts, bolts, screw, clips, and fittings. Never detach, move or alter existing vehicle wiring, including electrical grounds and straps. Alteration of existing vehicle components may make vehicle unsafe to operate. Should be no any electronic devices or magnetic pole around installation place.
- Air bags are vital part of a safety system. Never install main unit in a way which will alter air bag wiring or interfere with air bag deployment. Air bags must function properly in the event of an accident.
- Before installing, check the location of pipe, tank, electrical cables and others.
- Read and follow the instruction manual.
- Wiring location must not interfere driving, get in or out from car.
- Use electrical tape to insulate the ends of all wires, even if they are not used. Proper insulation prevents arcs, shocks and fires.
- When installation is complete, test all vehicle electrical systems to ensure they operate correctly, including lights, horn, brake lights, and emergency flashers.
- According to our sales policy, any problems caused by user's mistake, careless can not be guaranteed.



Caution

- All steps of installation should be done by well-trained specialist.
- During installation ignition key should be taken off and after all installation finish connect power cable with interface for the last step.
- Do not install the main unit in places where it ma be exposed to dew condensation (around the air conditioning hose, etc), or in locations where it may come in contact with water, high levels of moisture, dust or oily smoke
- Install wiring in a manner in which cables will not come in contact with metal parts. The wiring may be damaged by contact with metal parts, resulting in fire and shocks. Avoid all contact with hot surfaces when wiring the main unit. High temperatures may damage wiring, causing shorts, arcing and fires.
- Kindly check all parts are in the box, when receiving the product, if anything missing, inform to the supplier or manufacturer.

Table of Contents

1. Specifications	
1.1 Main Specifications	1
1.2 Features	2
1.3 System Diagram	3
1.4 Components	4
1.5 Exterior	5
2. Installation	
2.1 Installation Diagram.....	6
2.2 Installation	7
2.3 Connecting CAN Wires	8
3. Settings	
3.1 DIP Switch	9
3.2 Remote Control	10
3.3 Car Model and Navi Model	11
3.4 Factory Mode.....	12
3.5 IR-MEMORY input	14
3.6 Original Button Usage	17
3.7 Rear Camera	18
3.8 Rear Parking Guidelines	19
3.9 OSD	20
4. Trouble Shooting	22

1. Specifications

1.1 Main Specifications

1. Car Compatibility
VORKSWAGEN GOLF 7Generation
AUDI A3 2013~
2. Components
Interface* 1EA
3. MULTIMEDIA INTERFACE input specification
 - 3 * A/V input (video external input)
 - 1 * CVBS(Rear Camera) input
 - 1 * Analog RGB input (Navigation system)
 - 1 * LCD input (Car system input)
4. MULTIMEDIA INTERFACE output specification
 - 1 * LCD output
5. Power specification
 - Input power : 8VDC ~ 18VDC
 - Consumed power : 3.5WATT
6. Switch input mode
 - External display skip function : through DIP switch, can control each video input
 - Through remote control, can change input mode
 - Through CAN or rear lamp cable, rear camera can be detected

1. Specifications

1.2 Features

- Easy installation through connection with commander
- Able to adjust DVD, NAVI display on screen
- Improved Screen Display (user-oriented interface)
- Provide power cable to connect with rear camera
- Dynamic PAS(Parking assistance system), moving parking line according movement of steering wheel

1. Specification

1.3 System Diagram

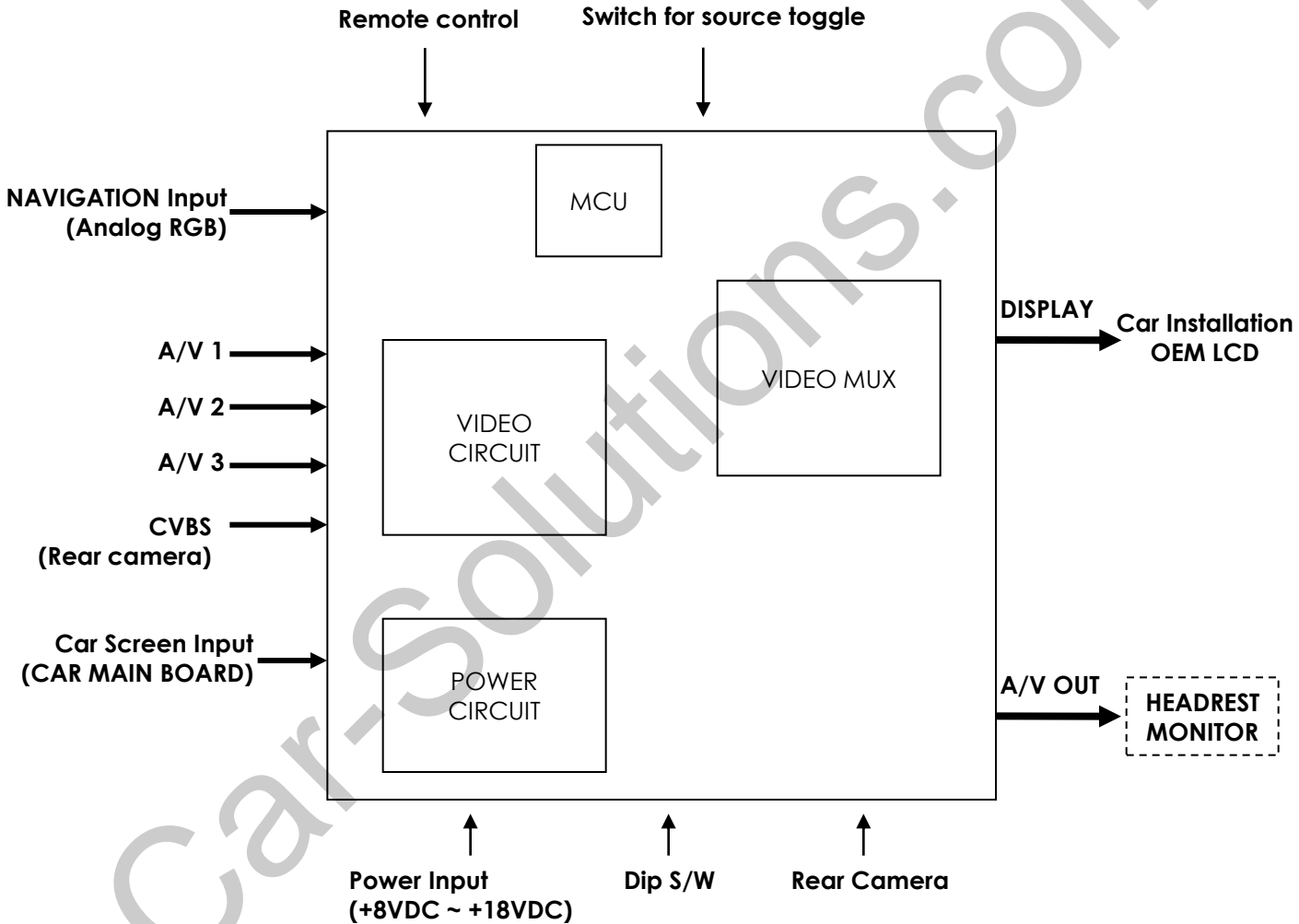

1. Specification

1.4 Components

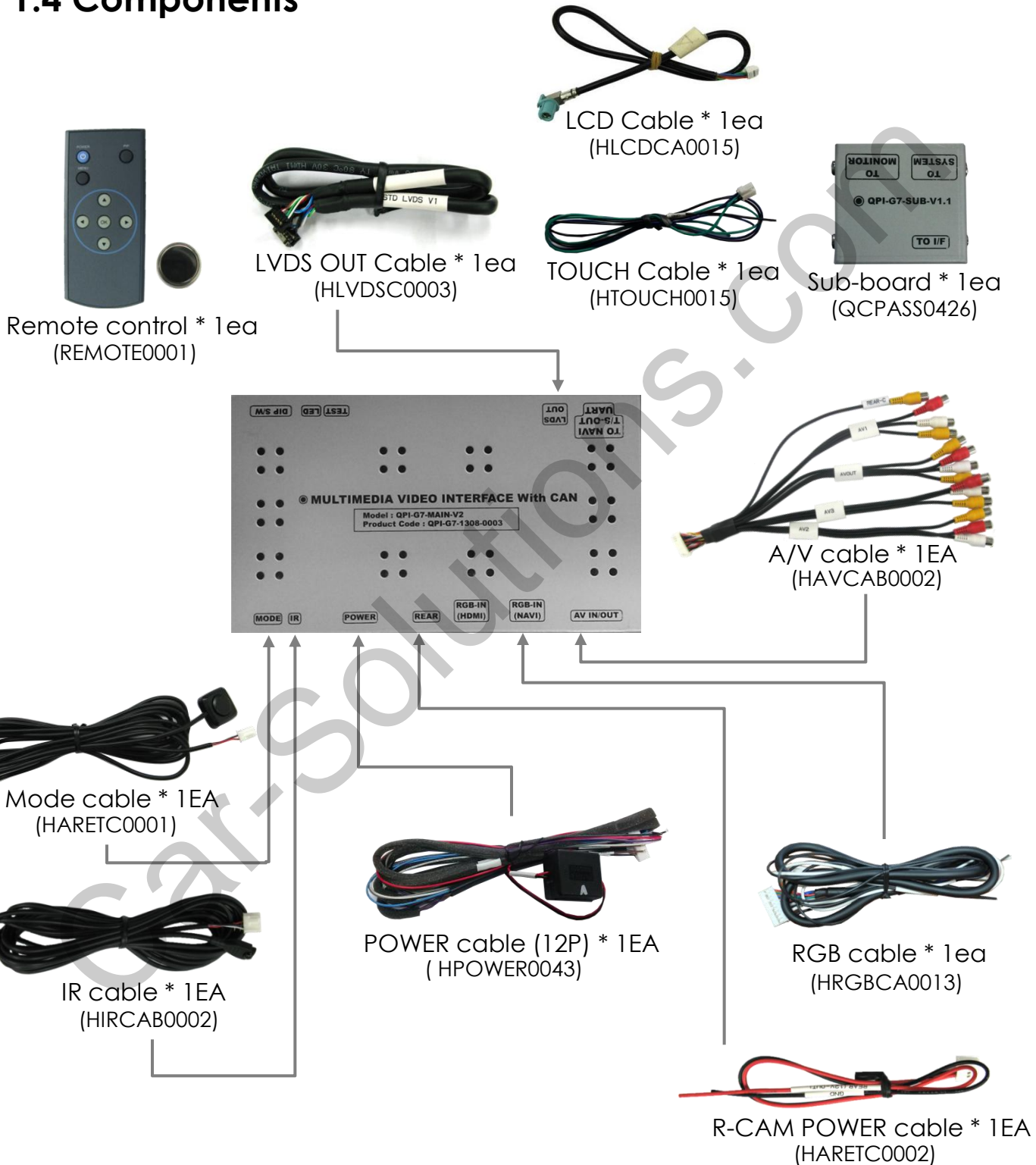

1. Specifications

1.5 Exterior

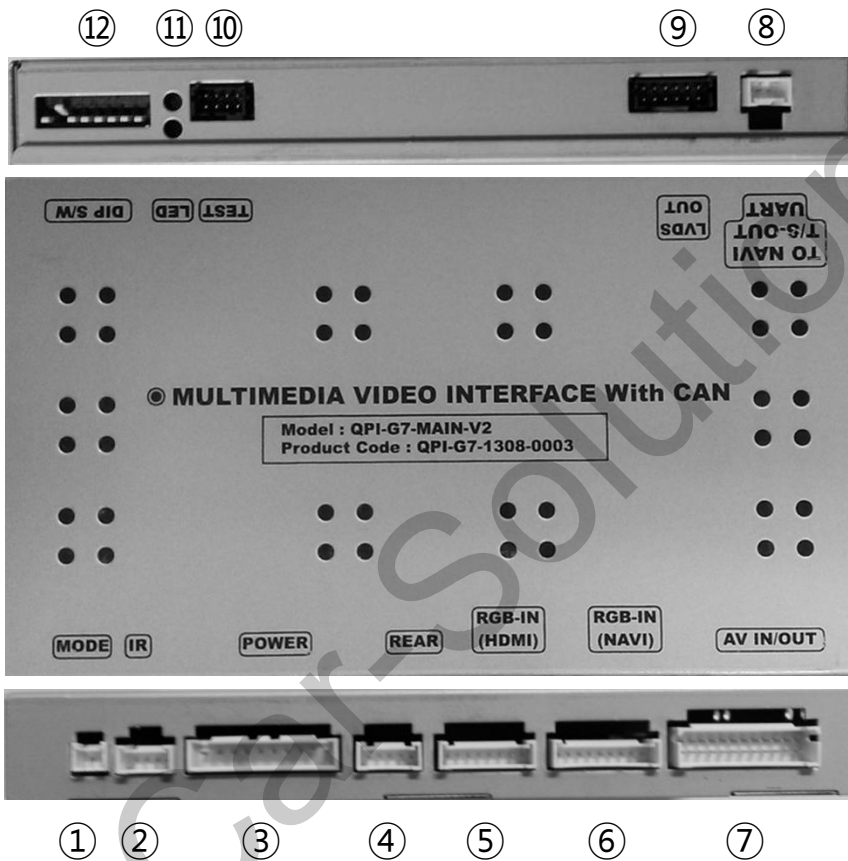

Dimension

Width 150.4mm

Length 99.4mm

Height 2.3.2mm

- ① MODE
- ② IR
- ③ POWER
- ④ REAR
- ⑤ RGB-IN(HDMI)
- ⑥ RGB-IN(NAVI)
- ⑦ AV IN/OUT
- ⑧ TO NAVI T/S-OUT UART
- ⑨ LVDS OUT
- ⑩ TEST
- ⑪ LED
- ⑫ DIP S/W

2. Installation

2.1 Installation Diagram

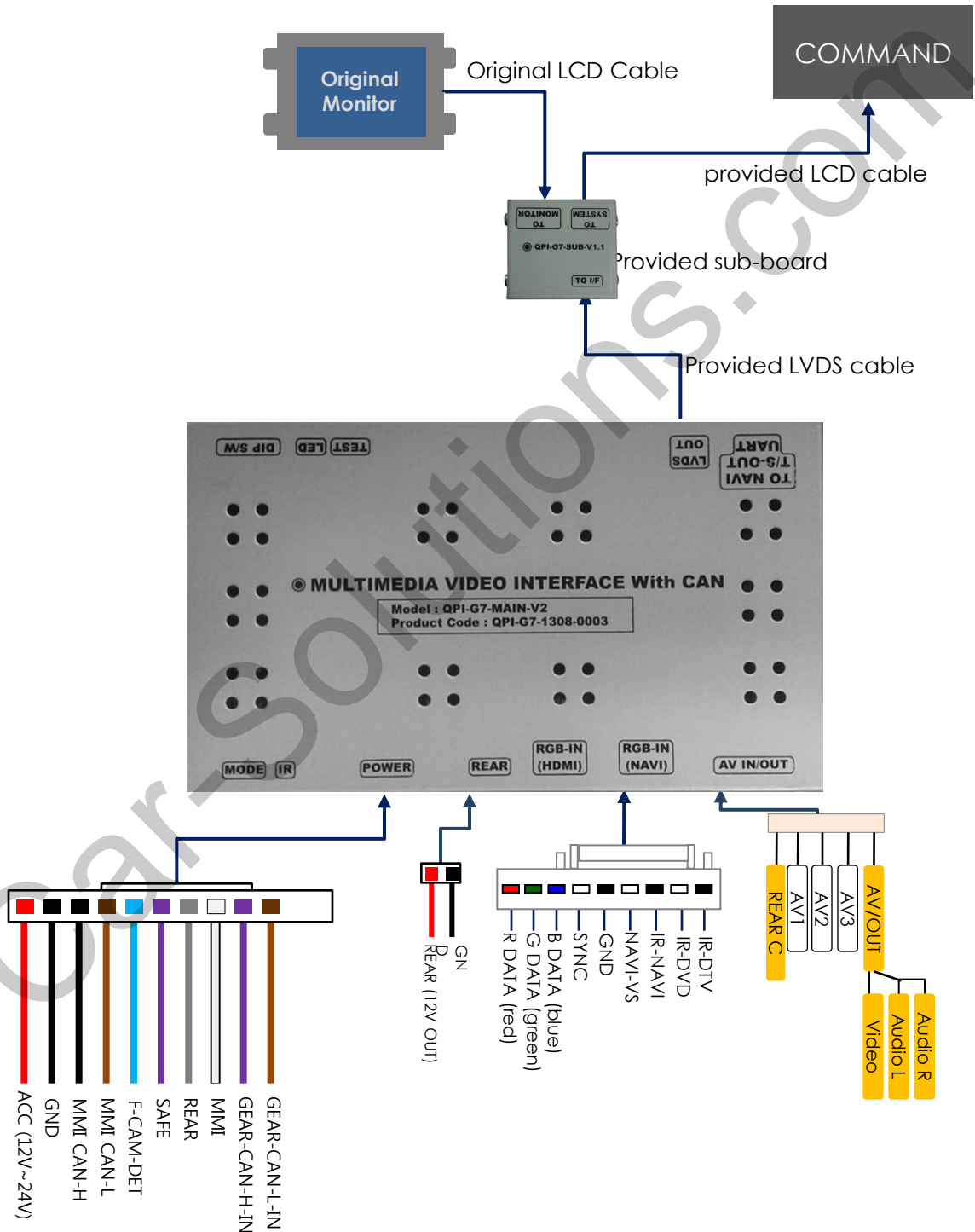

2. Installation

2.2 Installation

✘ After Dividing an original LCD Cable from the Command, the the cable connect to provided sub-board. And then provided LCD cable connect to command

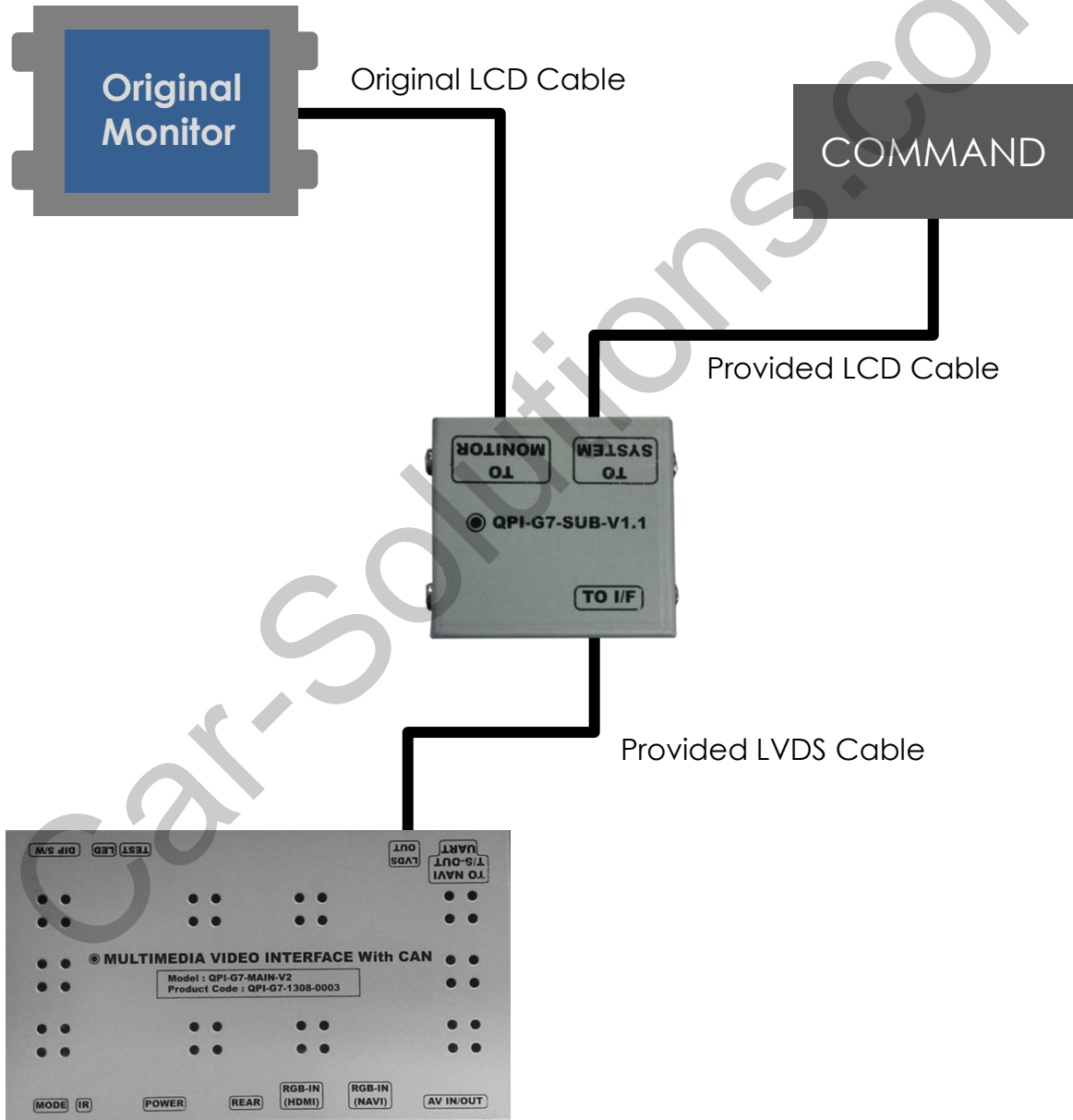

2. Installation

2.3 Connecting CAN Wires

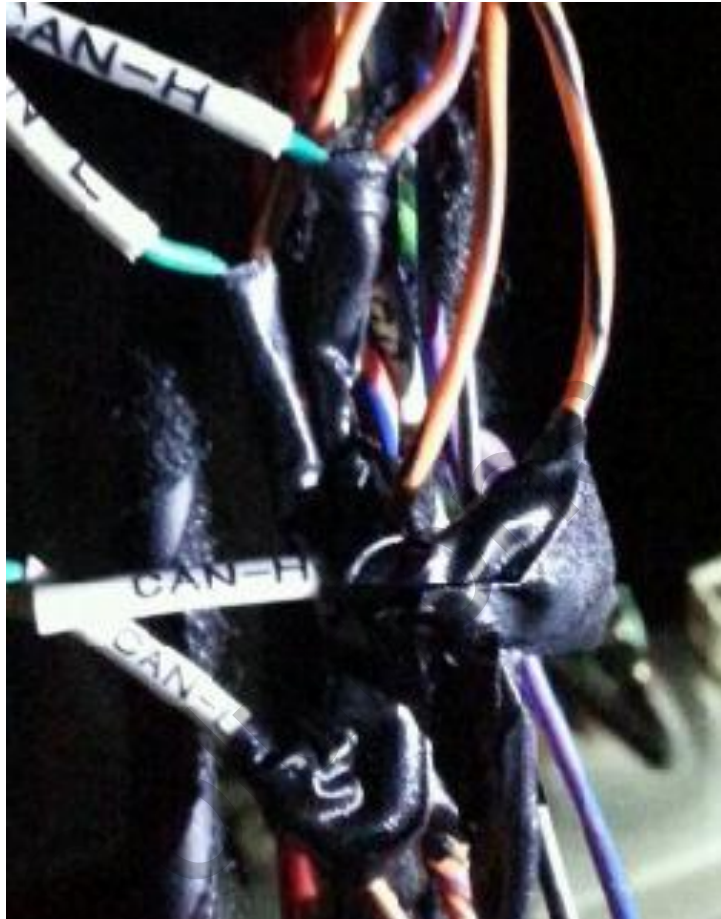

User can find original CAN wires behind air conditioner controls

Original CAN-High(Orange+Violet) wire connect with provided GEAR CAN-H(Violet : 9pin), original CAN-LOW(Orange+Brown) wire connect with provided GEAR CAN-L(Brown : 10pin)

Original CAN-High(Orange+Black) wire connect with provided MMI CAN-H(Black : 3pin), original CAN-LOW(Orange+Brown) wire connect with provided MMI CAN-L(Brown : 4pin)

3. Settings

3.1 DIP Switch

- ※ Example DIP S/W usage
- Use input mode : A/V2, A/V3
- Use original navigation
- External rear camera



※ ON : DOWN / OFF : UP
Default : #8 OFF

- ▷ DIP S/W : 1,2 → ON (hide INPUT MODE)
- ▷ DIP S/W : 3 → OFF (A/V2 display)
- ▷ DIP S/W : 4 → OFF (A/V3 display)
- ▷ DIP S/W : 5 → ON (AUDI A3)
- ▷ DIP S/W : 6 → OFF
- ▷ DIP S/W : 7 → ON (Use external rear cam)
- ▷ DIP S/W : 8 → OFF

PIN	Function	Dip S/W Selection
1	Displaying RGB input	ON : RGB mode skip OFF : RGB mode display
2	Displaying A/V 1	ON : A/V 1 mode skip OFF : A/V1 mode display
3	Displaying A/V 2	ON : A/V 2 mode skip OFF : A/V2 mode display
4	Displaying A/V 3	ON : A/V 3 mode skip OFF : A/V3 mode display
5	Select Car model	ON : AUDI A3 OFF : VW GOLF
6		N.C
7	Setup of rear camera use	ON : CVBS4 OFF : MAIN
8	Reset factory settings (not use for user)	ON : Product factory reset OFF : DEFAULT

3. Settings

3.2 Remote Control



<i>Key</i>	<i>Function</i>
POWER	Unavailable
PIP	A/V 1~2 Mode : Remote control UI Display A/V 3 Mode : Mode switching UI Display
MENU	Activating OSD menu
OK	Making a selection, changing image display
▲	Moving upward
▼	Moving downward
◀	Moving leftward (If you press this button 2 seconds long, you can access the factory mode.)
▶	Moving rightward (If you press this button 2 seconds long, you can reset all the data about user environment.)

3. Settings

3.3 Car Model and Navi Model

FACTORY mode – Press ◀ button 2 seconds long on the remote control.

▪ Setup for car model

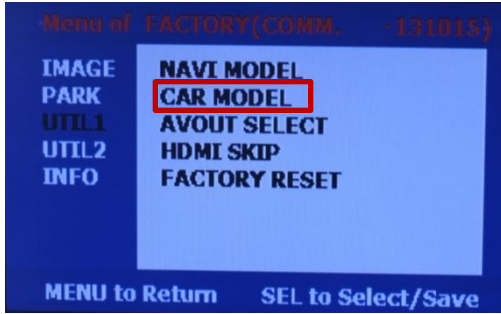

UTIL1 - CAR MODEL

Selecting model of the car

GOLF

▪ Setup for navigation

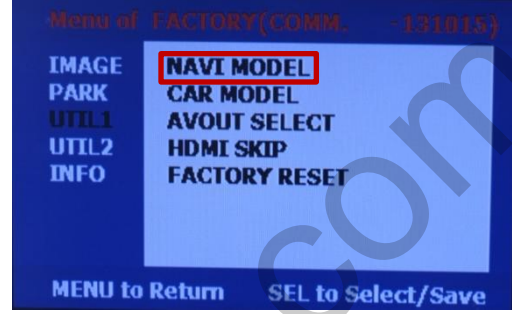

UTIL1 – NAVI MODEL

Definition of the navigation resolution

DEFAULT : default, 400X234, low resolution

*** Go into FACTORY/ IMAGE (as shown right) and adjust the position and the size of the navigation after setting the definition of the navigation**

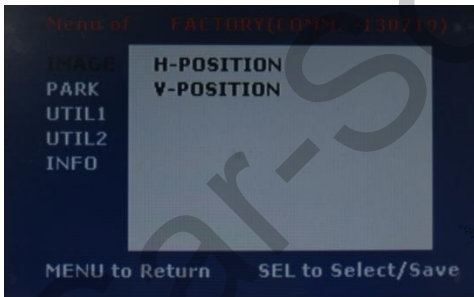

IMAGE

Adjust navigation position and size

H-POSITION : Move display horizontally

V-POSITION : Move display vertically

3. Settings

3.4 FACTORY Mode

FACTORY mode – Press ◀ button 2 seconds long on the remote control.

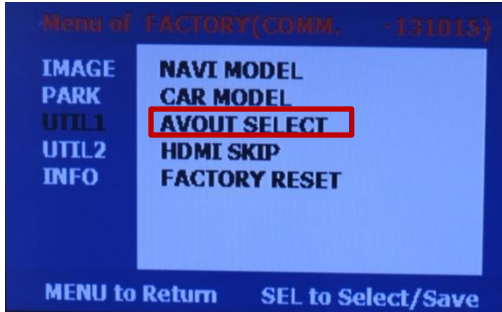

❑ UTIL1 – AVOUT SELECT

Selecting background sound
After
returning navigation or original
mode

DEFAULT : Selecting AV sound
just before changing
navigation or original mode
from the AV mode

AV 1~3 : Sound of the selected
AV source 1~3

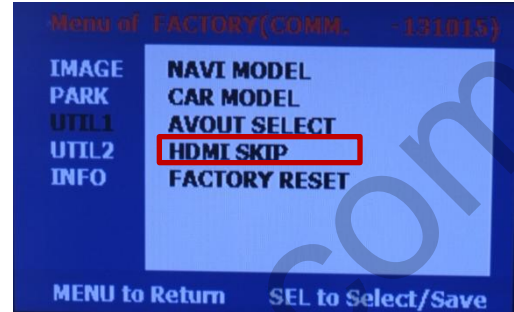

❑ UTIL1 – HDMI SKIP

Selecting use HDMI mode or
not

YES : Not use HDMI Mode
NO : Use HDMI Mode

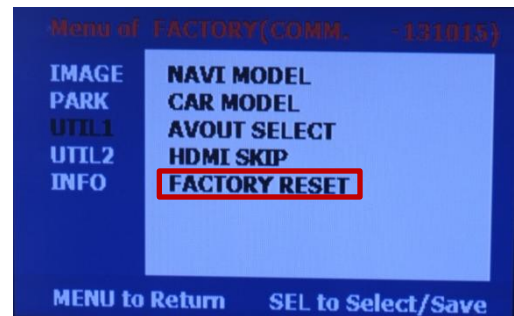

❑ UTIL1 - FACTORY RESET

FACTORY MODE RESET

Same functions as press long
to right button in remote
controller

3. Settings

3.4 FACTORY Mode

FACTORY mode – Press ◀ button 2 seconds long on the remote control.

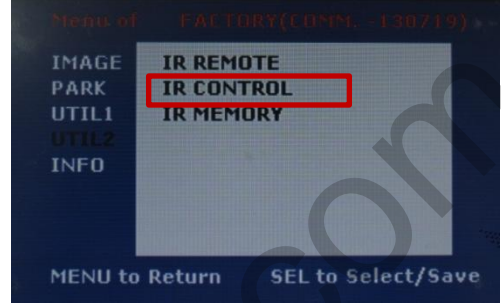
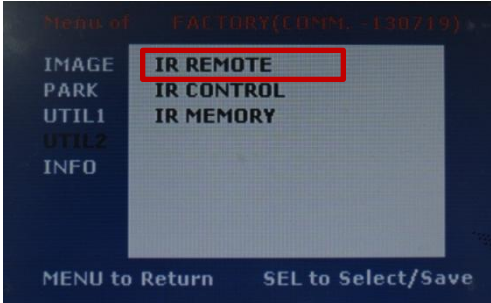

UTIL2 - IR REMOTE

Choose DTV and DVD model to be control them via remote controller

USER (when using IR MEMORY)

- Select navigation model:
Setting on RGB Mode
- Select DVD model : Setting on
A/V mode

UTIL2 - IR CONTROL

Selecting whether to use IR Remote function or not

ON / OFF

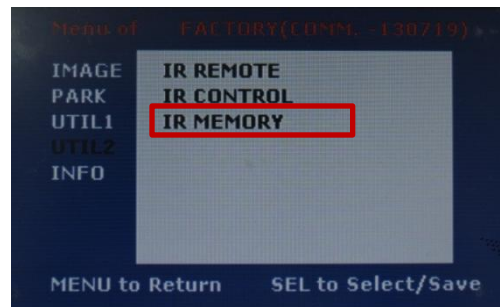

UTIL2 – IR MEMORY

To register DVD, DTV remote control, the remote control value must be registered and can be control with Screen remote controller

※ To use this function, in IR REMOTE select USER mode

DVD / DTV

3. Settings

3.5 IR Memory input

※ NAVI Setting

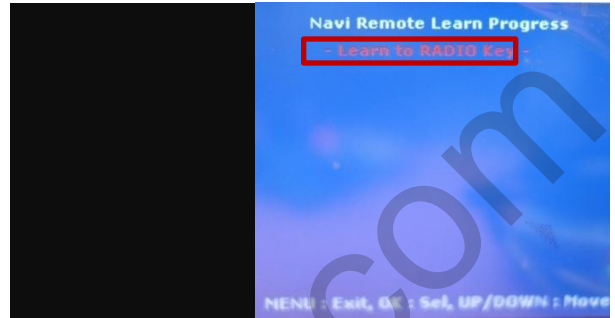
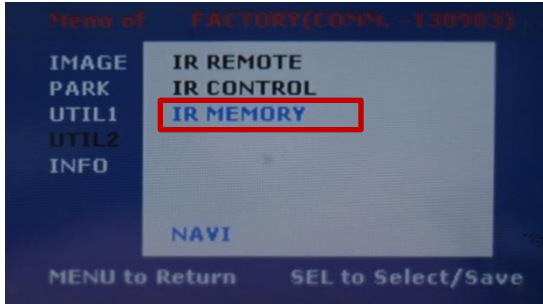

- ① Press ◀ button or UP→DOWN→UP→MENU button of remote to run factory menu and then choose UTIL2→IR MEMORY→NAVI

- ② After Step1. you will see image like above picture. System shows each MMI button name for your navigation button matching. Just press okay, if this is not the button you want, press up, down buttons to change to other MMI button.

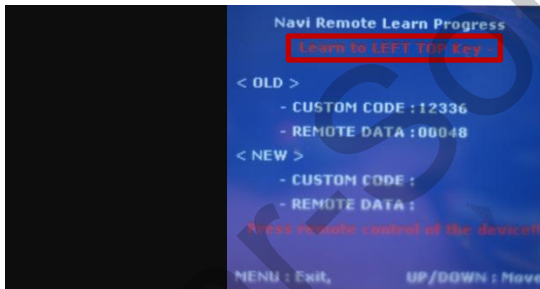

- ③ After Step2. you press your wanted navigation button IR for the appointed MMI button. You can set 11 MMI buttons in maximum with your 11 navigation remote IR keys.

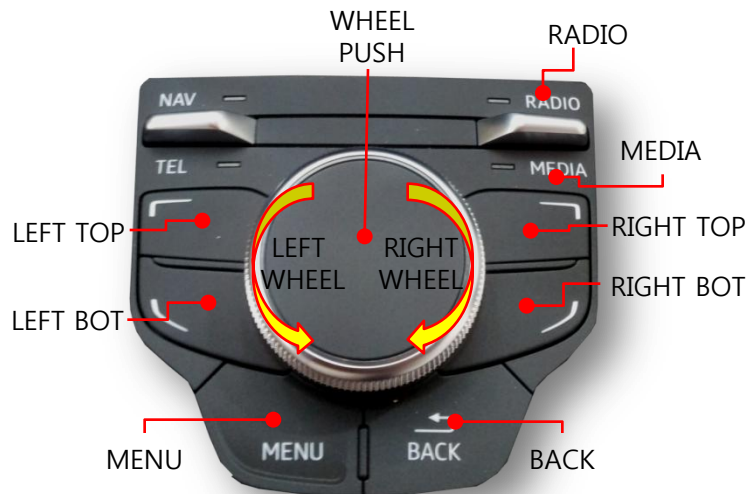

<Available MMI button Name>

3. Settings

3.5 IR Memory input

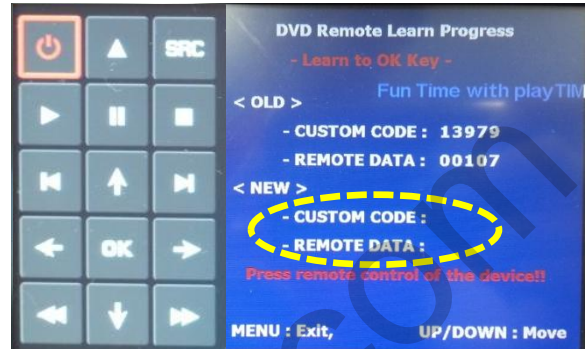
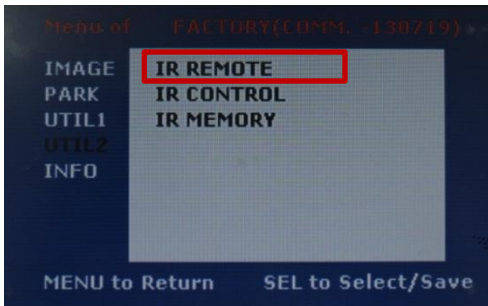

- ① First of all, press ◀ button on remote controller 2 seconds long or press UP→DOWN→UP→MENU button in order to access Factory mode. Choose IR MEMORY on I-DRV.

In IR MEMORY, you can choose AV source of DTV and DVD you want to use.

- ② Picture above shows DVD remote control button value input, select menu you want to save. (To register DVD remote control button value, select IR MEMORY – DTV and follow below instructions.

Example)

- a. After select OK button on OSD menu, press intended Remote controller button
- b. Indicated part above will flicker, and press POWER on DVD remote control.
(continue to next page)

What is IR-MEMORY Mode?

Is to allow Remote controller to control other DVD or DTV (besides the existing,; for example : SANYO, NECVOX) by register remote control value.

3. Settings

3.5 IR Memory input



example) continued..

c. The values that you registered will appear as green text in the marked area on pressing the button. And the values will be saved automatically.

d. Register remain buttons' value in OSD menu like the above-mentioned.

③ After register, select "SRC" button in OSD menu. Then you can see confirmation window as shown above. (If data is saved, DVD TYPE and DTV TYPE will be changed to "USER" automatically.)

The data is saved clearly and you can control DVD via remote controller. BUT, you MUST change the option in DVD(DTV)/IR Remote/UTIL2/FACTORY to "USER".

※ When press the "PIP button" on provided remote controller, user can control DVD, DTV using Remote control UI in screen via provided remote controller

※ 1. DVD(A/V1), DTV(A/V2) : When press the "PIP" button, Can see the remote controller UI on screen (To see the mode switching UI, press the "SRC" button on remote controller UI)

2. A/V3 : When press the "PIP" button, Can see the mode switching UI on screen

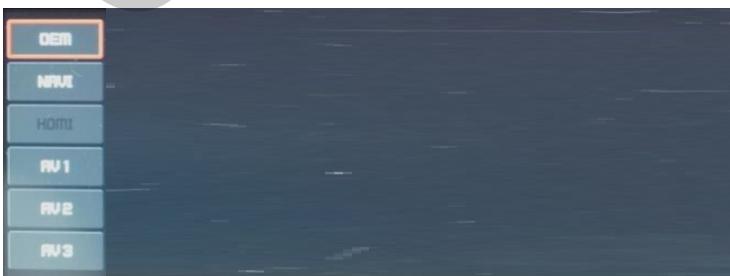

3. Settings

3.6 Original Button Usage

Press upward (NAV) : Switching Mode
(RGB→A/V1→A/V2→A/V3→Original)

Press downward (TEL) : Go to Original Screen

Press upward (RADIO) or downward (MEDIA)
: Go to Original Screen



3. Settings

3.7 Rear Camera

FACTORY mode – Press ◀ button 2 seconds long on the remote control.

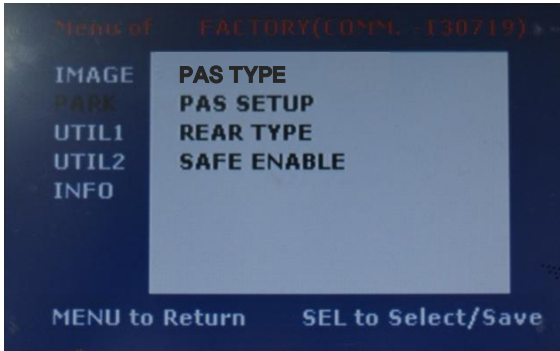

※ After installing rear camera : DIP S/W #7 must be put down (ON). Refer to page 9.

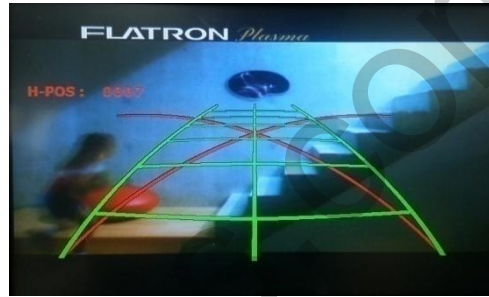

□ PARK

PAS TYPE : Selecting Type of parking guide line

- NOT USED : Not use Parking guide line
- PAS ON : Selecting Dynamic Parking guide line
- PAS OFF : Selecting fixed Parking guide line

PAS SETUP : Adjusting the position of the parking guide line (available in PARK SETUP-> V-POSITION, H-POSITION)

REAR TYPE : Choose rear camera recognition

- * LAMP - Detecting the rear view camera via rear lamp (Installer must connect "Rear-C" cable of the power cable to the rear lamp of the car.)
- *CAN - Detecting the rear view camera by CAN signal (Installer must connect "CAN" cable of the power cable to the "CAN" cable of the car.)

SAFE ENABLE : If your car is connected with CAN cable and it is in "ON" state, you can NOT watch DVD or A/V except original image or navigation while driving. At that time the screen get back to the main (default : OFF)

- If you want to get to the FACTORY mode, set the gear as rear state and press "LEFT" button 2 seconds long on the remote control or the keypad. (as shown left top)
- b. If you set 'PARK ENABLE' as "ON" state, there will be the rear view parking guide line. (as shown right top)

3. Settings

3.8 Rear Parking Guidelines

Go to Factory Menu, choose PAS SETUP, by using OK button change H-POS → V-POS → TYPES

□ H-POS

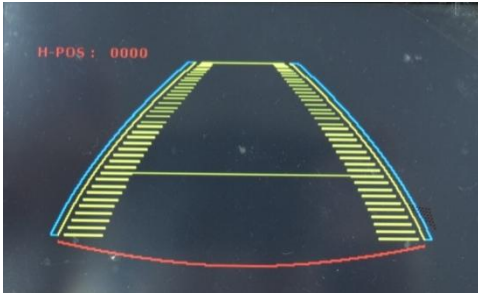

In H-POSITION, use ◀, ▶ on remote control, to adjust parking guideline left and right.

□ V-POS

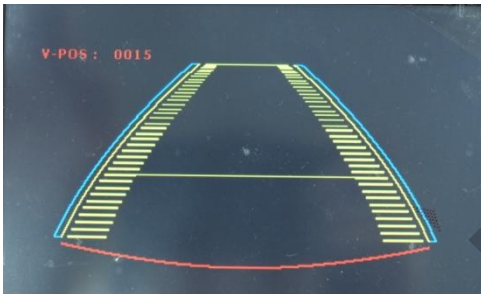

In V-POSITION use ▲, ▼ on remote control, to adjust parking guideline up and down.

□ TYPES

In TYPES, use ◀, ▶ on remote control, to Select parking guideline Type.



<TYPES : 0000>



<TYPES : 0002>

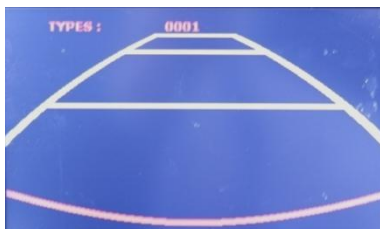

<TYPES : 0001>

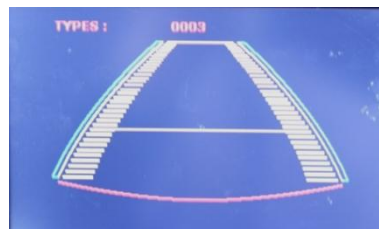

<TYPES : 0003>

3. Settings

3.9 OSD (On Screen Display) / Analog RGB Mode



□ IMAGE

- * BRIGHTNESS
- * CONTRAST
- * SHARPNESS



□ OSD

- * LANGUAGE : Set OSD language (only support English and Chinese)
- * TRANS : Adjust OSD transparency
- * H-POSITION : Move OSD horizontally
- * V-POSITION : Move OSD vertically

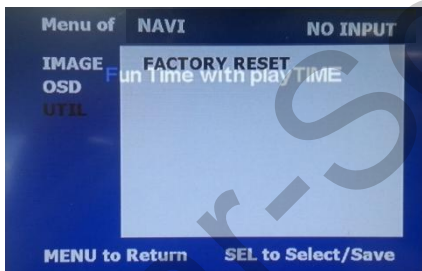

□ UTIL

- * FACTORY RESET
: Factory reset only for OSD function
(unable reset video position)

3. Settings

3.9 OSD (On Screen Display) / Video Mode



□ IMAGE

- * BRIGHTNESS
- * CONTRAST
- * SATURATION
- * HUE
- * SHARPNESS

□ OSD

- * LANGUAGE : Set OSD language (only support English and Chinese)
- * TRANS : Adjust OSD transparency
- * H_POSITION : Move OSD horizontally
- * V_POSITION : Move OSD vertically

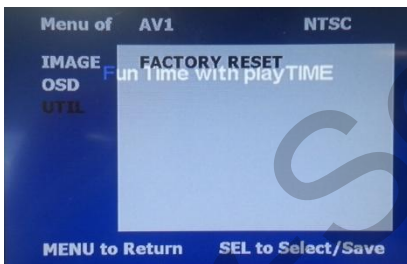

□ UTIL

- * FACTORY RESET
: Factory reset only for OSD function (unable reset video position)

4. Trouble Shooting

Q. I cannot change mode

- A. Check connection of Ground cable and IR Cable.
Check LED lamp is on, if not check connection of POWER cable.

Q. All I got on the screen is black.

- A. .Check second LED lamp of the interface is on, if not, check A/V sources connected are working well.
(Second lamp indicates AV sources connected works well.) Check interface connection has been done well.

Q. Displayed image color is not proper (too dark or unsuitable color)

- A. Try to select "INITIAL" in OSD menu, if it does not work, inform to manufacturer.

Q. I cannot watch the rear camera on the screen

- A. Set the DIP switch #7 as state "ON".

Q. Set mode not appear

- A. Check DIP Switch.

Q. OEM image is not displayed.

- A. Check interface's LCD In/Out cable connection. If the status keeps on, inform to manufacturer.

Q. Screen only displays white color.

- A. Check LCD out cable is connected well, if this status keeps, inform to manufacturer.

Q. Show PIP function via handle button, and original screen appear half only.

- A. This is not because of faulty interface, please check original monitor split function settings.

Q. After connect CAN cable, set gear "P", video doesn't appear.

- A. Go to "FACTORY MODE" and check "UTIL-Rear Select". Change "LAMP" settings to "CAN" with remote control.

※ LAMP : In case of connecting "Rear-C" wire of Power Cable to Rear Lamp in vehicle.