

Video Interface for Chevrolet with MyLink System

Manual

Update Date	2013.10.24
Model	QVI-LVTX-1CH-V7.1
Firmware Date	

Warning / Caution



Warning

- When installing the main unit, do not remove or alter existing vehicle fasteners, including nuts, bolts, screw, clips, and fittings. Never detach, move or alter existing vehicle wiring, including electrical grounds and straps. Alteration of existing vehicle components may make vehicle unsafe to operate. Should be no any electronic devices or magnetic pole around installation place.
- Air bags are vital part of a safety system. Never install main unit in a way which will alter air bag wiring or interfere with air bag deployment. Air bags must function properly in the event of an accident.
- Before installing, check the location of pipe, tank, electrical cables and others.
- Read and follow the instruction manual.
- Wiring location must not interfere driving, get in or out from car.
- Use electrical tape to insulate the ends of all wires, even if they are not used. Proper insulation prevents arcs, shocks and fires.
- When installation is complete, test all vehicle electrical systems to ensure they operate correctly, including lights, horn, brake lights, and emergency flashers.
- According to our sales policy, any problems caused by user's mistake, careless can not be guaranteed.



Caution

- All steps of installation should be done by well-trained specialist.
- During installation ignition key should be taken off and after all installation finish connect power cable with interface for the last step.
- Do not install the main unit in places where it ma be exposed to dew condensation (around the air conditioning hose, etc), or in locations where it may come in contact with water, high levels of moisture, dust or oily smoke
- Install wiring in a manner in which cables will not come in contact with metal parts. The wiring may be damaged by contact with metal parts, resulting in fire and shocks. Avoid all contact with hot surfaces when wiring the main unit. High temperatures may damage wiring, causing shorts, arcing and fires.
- Kindly check all parts are in the box, when receiving the product, if anything missing, inform to the supplier or manufacturer.

Table of Contents

1. Specifications	
1.1 Main Specifications -----	1
1.2 Features -----	2
1.3 System Diagram -----	3
1.4 Components -----	4
1.5 Exterior -----	5
2. Installation	
2.1 Installation Diagram-----	6
2.2 Installation -----	7
3. Settings	
3.1 DIP Switch -----	15
3.2 Remote Control -----	16
3.3 Factory Menu	
3.3.1 Image, Park -----	17
3.3.2 UTIL -----	19
3.4 OSD(ON SCREEN DISPLAY)	
3.4.1 ANALOG RGB MODE -----	23
3.4.2. VIDEO MODE -----	24
4. Trouble Shooting -----	25

1. Specifications

1.1 Main Specifications

1. Car Compatibility
Chevrolet with MyLink System
2. Components
Interface* 1EA
Sub-board* 1EA
3. MULTIMEDIA INTERFACE input specification
 - 3 * A/V input (video external input)
 - 1 * CVBS(Rear Camera) input
 - 2 * Analog RGB(Navigation, HDMI)
 - 1 * LCD input (Car system input)
4. MULTIMEDIA INTERFACE output specification
 - 1 * LCD output
 - 1 * Audio output
 - 2 * CVBS output
5. Power specification
Input power : 8VDC ~ 16VDC
Consumed power : 4WATT
6. Switch input mode
 - External display skip function : through DIP switch, can control each video input
 - Through remote control, can change input mode
 - Available to switch mode via Toggle Switch

1. Specifications

1.2 Features

- Able to adjust DVD, NAVI display on screen
- Improved Screen Display (user-oriented interface)
- Provide power cable to connect with rear camera

1. Specification

1.3 System Diagram

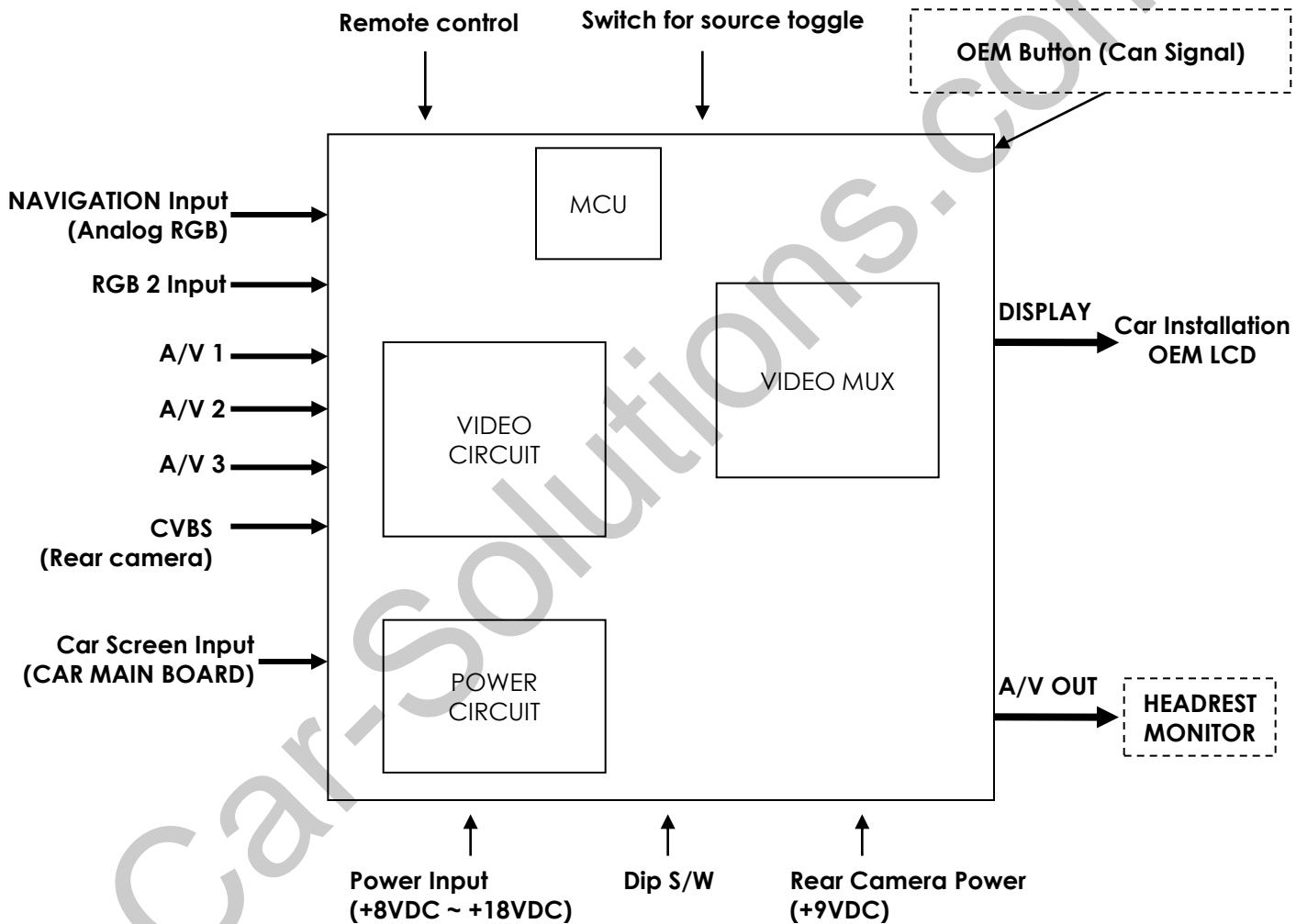

1. Specification

1.4 Components



FFC cable(BIG)*1ea
(FFCABL0012)



FPC cable* 1ea
(FFCABL0023)

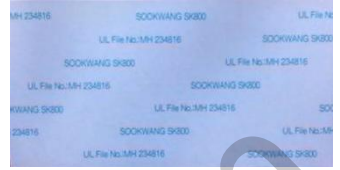

Sub board sticker * 1ea



TOUCH OUT cable * 1ea
(HTOUCH0004)



LVDS cable * 1ea
(HLVDSC0018)

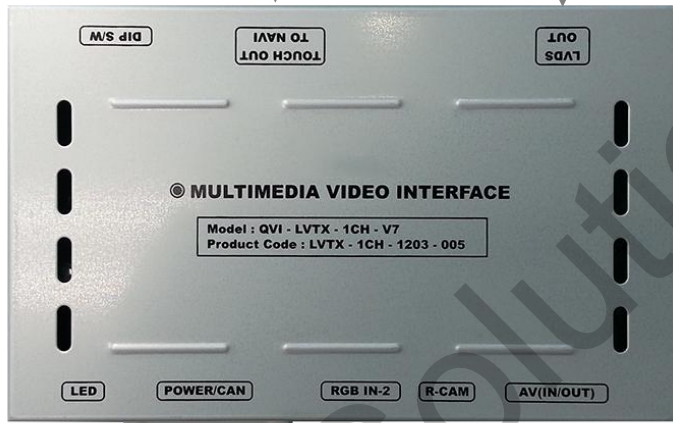

Sub-board * 1ea
(QCPASS0434)

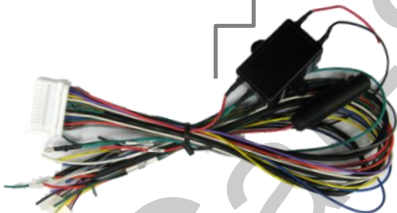

POWER cable (24P) * 1ea
(HPOWER0011)



REAR CAMERA POWER cable * 1ea
(HARETC0002)



A/V cable * 1ea
(HAVCAB0002)



TOUCH cable * 1ea
(HTOUCH0002)



IR cable * 1ea
(HIRCAB0002)



MODE cable * 1ea
(HARETC0001)



RGB cable * 1ea
(HNAVIC0004)



REMOTE CONTROL * 1ea
(REMOTE0001)

1. Specifications

1.5 Exterior



Dimension

width 125mm
Length 105mm
Height 21mm

- ① LED
- ② POWER
- ③ RGB IN-2
- ④ R-CAM
- ⑤ AV(IN/OUT)
- ⑥ DIP SWITCH
- ⑦ TOUCH OUT TO NAVI
- ⑧ LVDS OUT

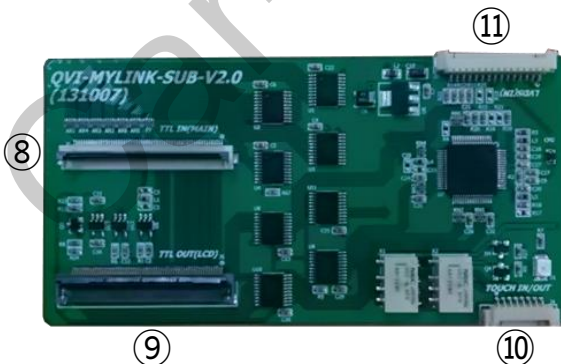

- ⑧ TTL IN(DATA)
- ⑨ TTL OUT(LCD)
- ⑩ TOUCH IN/OUT
- ⑪ LVDS(IN)

- SUB BOARD -
(W75*H47*D20)

2. Installation

2.1 Installation Diagram

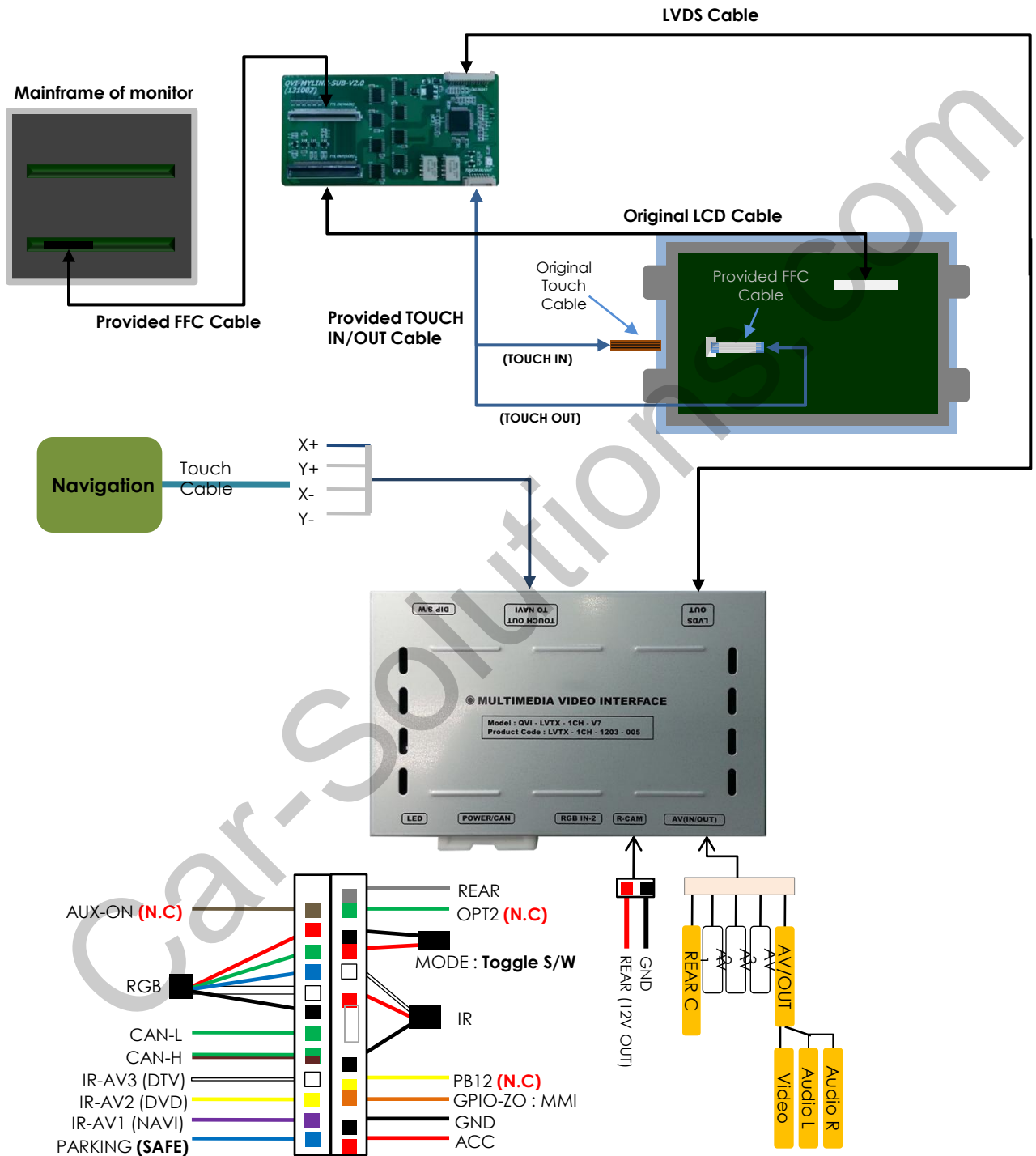

2. Installation

2.2 Installation



-
- ① Separate monitor from car. Unfasten bolt on the back side of monitor (refer to red circle).

2. Installation

2.2 Installation

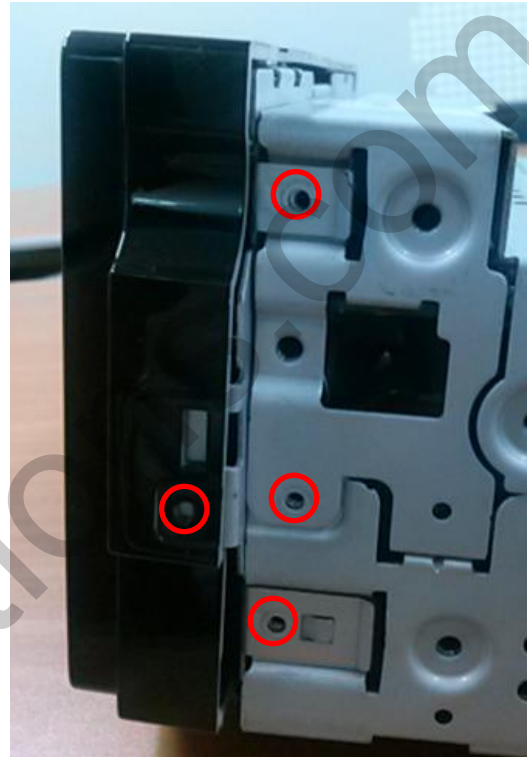

-
- ① Unfasten bolt on each sides (red circle) and separate LCD.

2. Installation

2.2 Installation



- ① After separating LCD, unfasten bolt (shown red circle) and take of the plate.

2. Installation

2.2 Installation



- ① Take out original touch cable and replace with our TOUCH IN cable (provided).
- ② Put FFC cable (provided) on the place where original touch cable placed and connect with TOUCH OUT cable (provided).

2. Installation

2.2 Installation



- ① Through the hole (refer red circle), take out provided touch cable and put the plate back to close.
- ② Connect original LCD MAIN cable with sub board's TTL OUT (LCD), and connect our touch cable with sub board's TOUCH IN/OUT.

2. Installation

2.2 Installation



- ① Pick up our LVDS cable (provided) through backside of main monitor.
- ② Connect LVDS cable with sub board's LVDS(IN), connect FFC cable (provide) with TTL IN(MAIN) on the sub board.

2. Installation

2.2 Installation



- ① Connect FFC cable (provided) with head unit monitor (refer above picture).

2. Installation

2.2 Installation

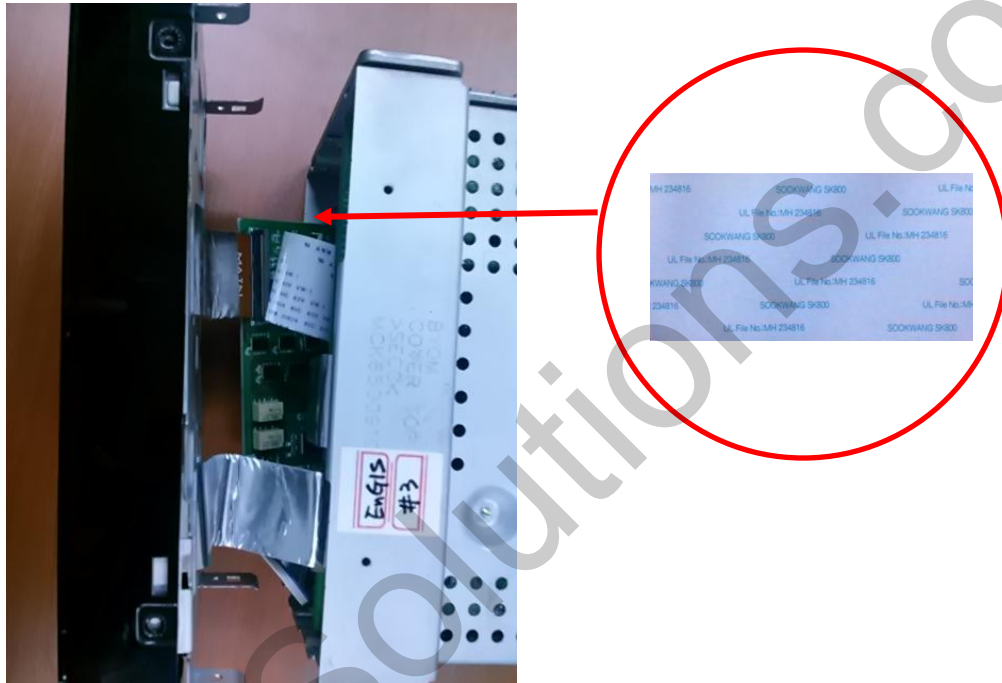

- ① Put double tape (provided) on the bottom of sub board, place and fix lower part of head unit monitor with sub board. Assemble the LCD with the same method when dismantling it.

3. Settings

3.1 DIP Switch

- ※ Example DIP S/W usage
 - Use input mode : A/V3, Navigation(RGB)
 - Use external navigation
 - External rear camera



※ ON : DOWN / OFF : UP
Default : #8 OFF

- ▷ DIP S/W : 1 → OFF
- ▷ DIP S/W : 2,3 → ON (A/V1,2 Skip)
- ▷ DIP S/W : 4 → OFF (A/V3 display)
- ▷ DIP S/W : 5 → ON
- ▷ DIP S/W : 6 → ON
- ▷ DIP S/W : 7 → ON (display external rear cam)
- ▷ DIP S/W : 8 → OFF

<i>PIN</i>	<i>Function</i>	<i>Dip S/W Selection</i>
1	Displaying RGB input	ON : RGB mode skip OFF : RGB mode display
2	Displaying A/V 1	ON : A/V 1 mode skip OFF : A/V1 mode display
3	Displaying A/V 2	ON : A/V 2 mode skip OFF : A/V2 mode display
4	Displaying A/V 3	ON : A/V 3 mode skip OFF : A/V3 mode display
5		N.C
6		N.C
7	Setup of rear camera use	ON : CVBS4 OFF : MAIN
8	Navigation Skip	ON : OEM Navigation OFF : External Navigation (DEFAULT)

3. Settings

3.2 Remote Control



<i>Key</i>	<i>Function</i>
POWER & PIP	Unavailable
MENU	Activating OSD menu
OK	Making a selection, changing image display
▲	Moving upward
▼	Moving downward
◀	Moving leftward (If you press this button 2 seconds long, you can access the factory mode.)
▶	Moving rightward (If you press this button 2 seconds long, you can reset all the data about user environment.)

3. Settings

3.3.1 FACTORY MODE-IMAGE, PARK

FACTORY mode – Press ◀ button 2 seconds long on the remote control.

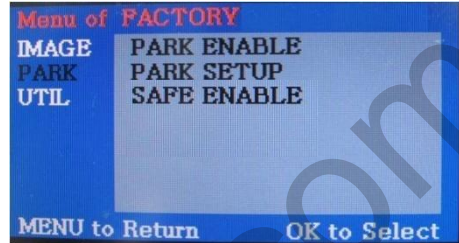
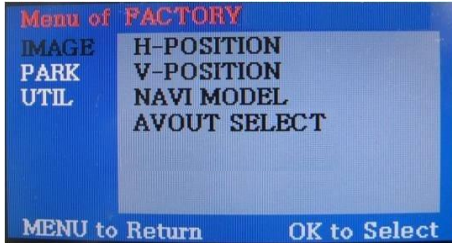

IMAGE

Adjust navigation position and size

H-POSITION : Move display horizontally

V-POSITION : Move display vertically

NAVI MODEL : Default, kd-900,
MYVI, GI 5000, GI 5000A, GI 8000N
A CLASS, WP9200, NAV506TP, PAPAGO

AVOUT SELECT : Selecting background
sound After
returning navigation or original mode

DEFAULT : Selecting AV sound just
before changing navigation or original
mode from the AV mode

AV 1~3 : Sound of the selected AV
source 1~3

PARK

PAS ENABLE : Selecting whether
to display the parking guide line
or not on rear gear (default : ON)

PAS SETUP : Adjusting the position
of the parking guide
line

SAFE ENABLE : If your car is
connected with CAN
cable and it is in "ON"
state, you can NOT
watch DVD or A/V
except original
image or navigation
while driving. At that
time the screen get
back to the main
(default : OFF)

3. Settings

3.3.1 FACTORY MODE-IMAGE, PARK

FACTORY mode – Press ◀ button 2 seconds long on the remote control.

Go to Factory Menu, choose PAS SETUP, by using OK button change H-POS → V-POS

□ H-POS



In H-POSITION, use ◀, ▶ on remote control, to adjust parking guideline left and right.

□ V-POS



In V-POSITION use ▲, ▼ on remote control, to adjust parking guideline up and down.

3. Settings

3.3.2 FACTORY MODE-UTIL

FACTORY mode – Press ◀ button 2 seconds long on the remote control.

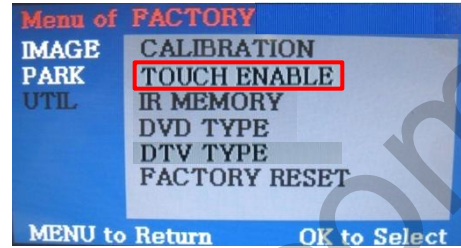
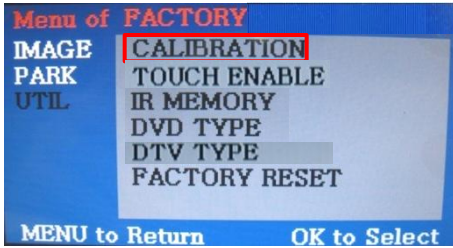

UTIL – CALIBRATION

Touch Calibration

YES / NO

TOUCH ENABLE

To select whether to use TOUCH

YES / NO

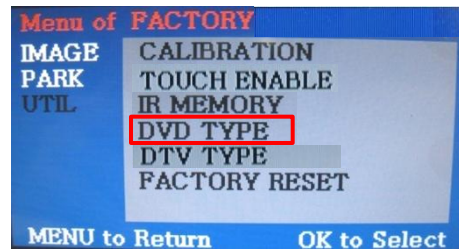
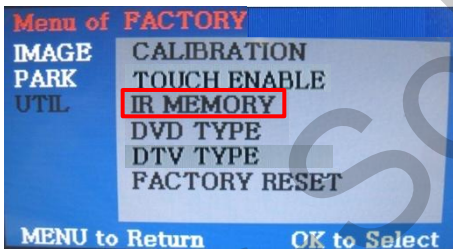

UTIL – IR MEMORY

After register DVT, DTV
Remote control value, Can
control DVD, DTV by remote
control UI

※ To use this function, in UTIL-
DVD / DTV TYPE select USER
mode

UTIL – DVD TYPE

Selecting DVD model

3. Settings

3.3.2 FACTORY MODE-UTIL

FACTORY mode – Press ◀ button 2 seconds long on the remote control.

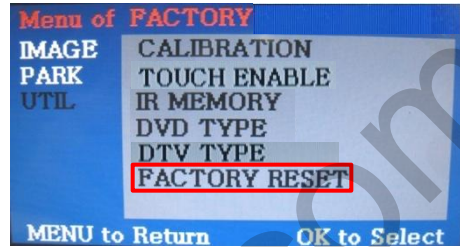
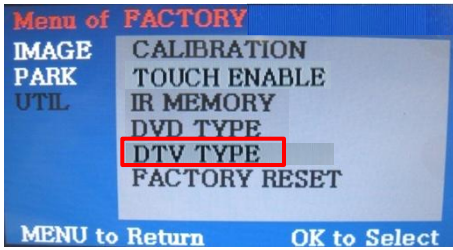

❑ UTIL – DTV TYPE

Selecting DTV model

❑ UTIL – FACTORY RESET

FACTORY MODE RESET

Same functions as press long to right button in remote controller

3. Settings

3.3.2 FACTORY MODE-UTIL

FACTORY mode – Press ◀ button 2 seconds long on the remote control.

□ UTIL – IR MEMORY

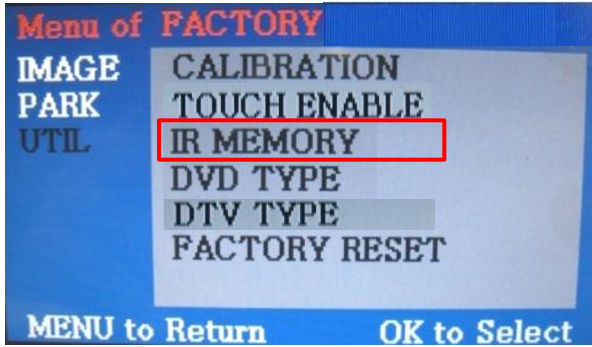

- ① First of all, press ◀ button on remote controller 2 seconds long or press UP→DOWN→UP→MENU button in order to access Factory mode. Choose IR MEMORY on UTIL2.

In IR MEMORY, you can choose AV source of DTV and DVD you want to use.

- ② Picture above shows DVD remote control button value input, select menu you want to save. (To register DVD remote control button value, select IR MEMORY – DTV and follow below instructions.

Example)

- a. After select POWER button on OSD menu, press intended OK button on Remote control
- b. Indicated part above will flicker, and press POWER on DVD remote control. (continue to next page)

What is IR-MEMORY Mode?

Is to allow MMI and touch screen to control other DVD or DTV (besides the existing,; for example : SANYO, NECVOX) by register remote control value.

3. Settings

3.3.2 FACTORY MODE-UTIL

FACTORY mode – Press ◀ button 2 seconds long on the remote control.

☐ UTIL – IR MEMORY

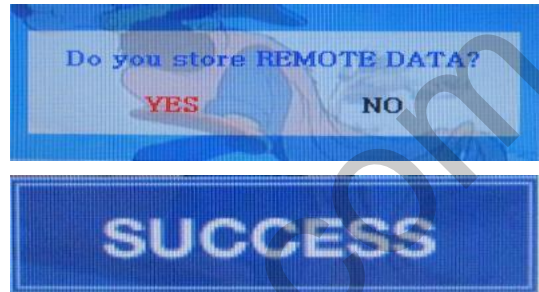

Instruction> continued...

c. The values that you registered will appear as green text in the marked area on pressing the button. And the values will be saved automatically.

d. Register remain buttons' value in OSD menu like the above-mentioned.

- ③ After register, select "INPUT" button in OSD menu. Then you can see confirmation window as shown above. At the moment, (If data is saved, DVD TYPE and DTV TYPE will be changed to "USER" automatically.)

If you see "SUCCESS" on screen, the data is saved clearly and you can control DVD via touch screen. BUT, you MUST change the option in FACTORY-UTIL-DVD to "USER".

3. Settings

3.4.1 OSD (On Screen Display) / Analog RGB Mode

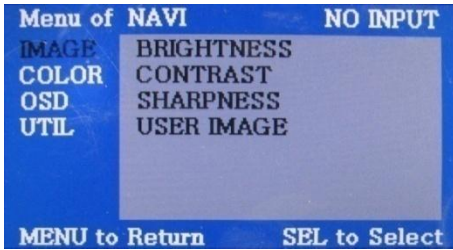

IMAGE

- * BRIGHTNESS
- * CONTRAST
- * SHARPNESS
- * USER IMAGE

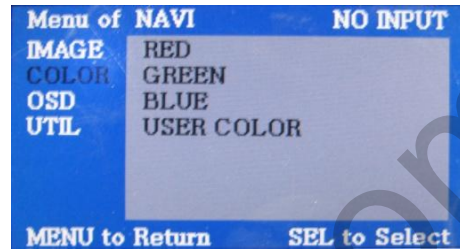

COLOR

- * RED
- * GREEN
- * BLUE
- * USER COLOR

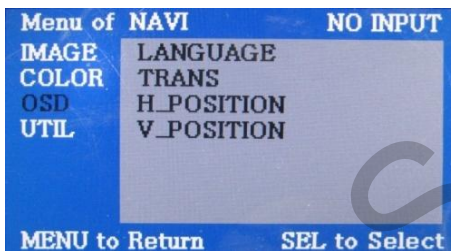

OSD

- * LANGUAGE : Set OSD language (only support English and Chinese)
- * TRANS : Adjust OSD transparency
- * H-POSITION : Move OSD horizontally
- * V-POSITION : Move OSD vertically

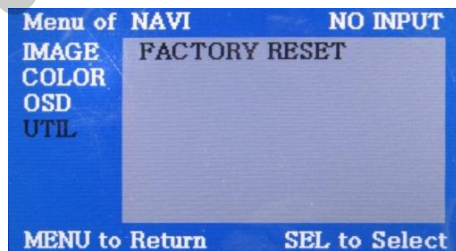

UTIL

- * FACTORY RESET : Factory reset only for OSD function (unable reset video position)

3. Settings

3.4.2 OSD (On Screen Display) / Video Mode



IMAGE

- * BRIGHTNESS
- * CONTRAST
- * SATURATION
- * HUE
- * SHARPNESS
- * USER IMAGE

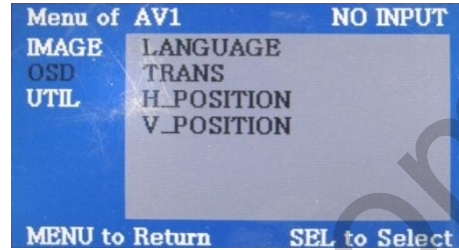

OSD

- * LANGUAGE : Set OSD language (only support English and Chinese)
- * TRANS : Adjust OSD transparency
- * H_POSITION : Move OSD horizontally
- * V_POSITION : Move OSD vertically

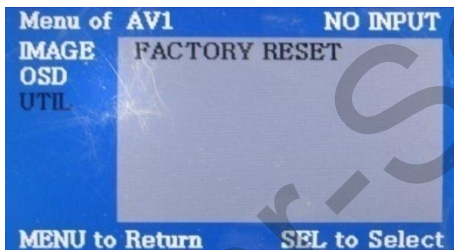

UTIL

- * FACTORY RESET
: Factory reset only for OSD function
(unable reset video position)

4. Trouble Shooting

Q. I cannot change mode

- A. Check connection of Ground cable and IR Cable.
Check LED lamp is on, if not check connection of POWER cable.

Q. All I got on the screen is black.

- A. .Check second LED lamp of the interface is on, if not, check A/V sources connected are working well.
(Second lamp indicates AV sources connected works well.) Check interface connection has been done well.

Q. Displayed image color is not proper (too dark or unsuitable color)

- A. Try to select "INITIAL" in OSD menu, if it does not work, inform to manufacturer.

Q. I cannot watch the rear camera on the screen

- A. Set the DIP switch #7 as state "ON".

Q. Set mode not appear

- A. Check DIP Switch.

Q. OEM image is not displayed.

- A. Check interface's LCD In/Out cable connection. If the status keeps on, inform to manufacturer.

Q. Screen only displays white color.

- A. Check LCD out cable is connected well, if this status keeps, inform to manufacturer.

Q. Show PIP function via handle button, and original screen appear half only.

- A. This is not because of faulty interface, please check original monitor split function settings.

Q. After connect CAN cable, set gear "P", video doesn't appear.

- A. Go to "FACTORY MODE" and check "UTIL-Rear Select". Change "LAMP" settings to "CAN" with remote control.

※ LAMP : In case of connecting "Rear-C" wire of Power Cable to Rear Lamp in vehicle.