

Instruction manual

Fusion Splicer **12S**



Please read this instruction manual carefully before operating the equipment.

Adhere to all safety instructions and warnings contained in this manual.

Keep this manual in a safe place.

There is a change without a previous notice.

We are not responsible for the products which are not purchased from our authorized distributors.

Please consent beforehand.

Copying some or all of instruction manual without notice is forbidden. Moreover, without permission from our company, it cannot use on the Copyright Act except that it uses as an individual.

Safety Information	1
General information	6
Introduction	6
New function of 12S	7
Description of Product	8
Components of Splicer	8
Other Necessary Items for Splicing Operation	9
Description and Function of Splicer	10
Operation of Sheet Key	11
Basic Operation	12
Splicing work preparation	12
Power Supply	13
Turning Splicer ON/OFF	17
LCD Brightness adjustment	17
Splicer Settings Check	18
Change of the Splice Mode	18
Select of the Heater Mode	20
Preparation of fiber	22
Arc Calibration	25
Splicing procedure	27
Storing splicing results	30
How to input Mode Title/Comment/Password	30
Fiber Proof Test	31
Removing spliced fiber	31
Insertion of the protection sleeve	31
Heating protection sleeve	32
Maintenance of Splicing Quality	33
Cleaning and Checking before Splicing	33
Periodical Checking and Cleaning	35
Splice Settings	38
Splice Settings	39
Splice Mode	39
Select Splice Mode	40
Memory	47
Splice Memory Comment	49

Heater Menu	50
Select Heater Mode.....	50
About heating of a connector splice part.....	53
Setting Menu	54
Splice Settings	54
Maintenance Settings	55
Machine Settings.....	56
Menu Lock Settings	58
Maintenance Menu.....	59
Maintenance Menu information	59
Replace Electrodes	60
Stabilize Electrodes	61
Clear Arc Count	61
Motor Drive.....	62
Diagnostic Test.....	63
Dust Check.....	64
Arc Calibration.....	65
Motor Calibration.....	67
Maintenance Info.....	67
Error Message List.....	68
Questions and Troubleshooting	73
Power Supply	73
Splicing Operation	74
Tube-heating Operation.....	76
Supervising	76
Other Functions	77
Guarantee and Contact Address.....	78
Guarantee	78
Contact Address	79

The splicer has been designed for splicing Silica-based optical fibers for telecommunications. Do not attempt to use this machine for other applications. Fujikura Ltd. gives much consideration and regard to personal injury. Misuse of the machine may result in electric shock, fire and/or serious personal injury.

Follow all safety instructions

Read and understand all safety instructions.

Stop using it when it malfunctions

Ask our service centers for repair as soon as possible.

Instruction Manual

Read this instruction manual carefully before operating this machine. Store this instruction manual in a safe place.

The following alert symbols are used in this instruction manual and machine to indicate warnings and caution for safe use. Understand the meanings of these symbols.



WARNING!

There is a possibility of death or serious injury resulting from improper use by ignoring this indication.



CAUTION!

There is a possibility of personal injury or physical loss resulting from improper use by ignoring this indication.

Symbol means "Pay attention"



Pay attention to hot surface!

Symbol means "Must not do"



You must not disassemble!

Symbol means "Must do"



You must disconnect a plug!



WARNINGS!

Disconnect the AC power cord from the AC adapter inlet or the wall socket (outlet) immediately if user observes the following or if the splicer receives the following faults:

- Fumes, bad smell, noise, or over-heat occurs.
- Liquid or foreign matter falls into cabinet.
- Splicer is damaged or dropped.



If this occurs, ask our service center for repair. Leaving the splicer in a damaged state may cause equipment failure, electric shock or fire and may result in personal injury, death or fire.



AC adapter which be used for a splicer is only an adapter for exclusive use.

Using an improper AC power source may cause fuming, electric shock or equipment damage and may result in personal injury, death or fire.



Use the supplied AC power cord. Do not place heavy objects on the AC power cord.

Use of an improper cord or a damaged cord may cause fuming, electric shock or equipment damage and may result in personal injury, death or fire.



Do not disassemble or modify the splicer, AC adapter or battery. In particular, do not remove or bypass any electrical or mechanical device (e.g. a fuse or safety switch) incorporated into the design and manufacturing of this equipment. Modification could cause damage that may result in personal injury, death, electric shock or fire.



Never operate the splicer in an environment where flammable liquids or vapors exist.

Risk of dangerous fire or explosion could result from the splicer's electrical arc in such an environment.



Do not use compressed gas or canned air to clean the splicer. They may contain flammable materials that could ignite during the electrical discharge.



Do not touch the electrodes when the splicer is on and power is supplied to the unit. The electrodes generate high voltage and high temperatures that may cause a severe shock or burn.

Note Arc discharge stops when wind protector is opened. Turn the splicer off and disconnect the AC power cord before replacing electrodes.



Safety glasses should always be worn during fiber preparation and splicing operation.

Fiber fragments can be extremely dangerous if it comes into contact with the eye, skin, or is ingested.



WARNINGS!

Use only proper power source.

- Proper AC power source is AC100-240V, 50-60Hz. Check the AC power source before use. Proper DC power source is DC10-12V. Improper AC or DC power source may cause fuming, electric shock or equipment damage and may result in personal injury, death or fire.
- AC generators commonly produce abnormally high AC output voltage or irregular frequencies. Measure the output AC voltage with a circuit tester before connecting the AC power cord. Such abnormally high voltage or frequency from a generator may cause fuming, electric shock or equipment damage and may result in personal injury, death or fire. Make sure the generator is regularly checked and serviced.
- An AC adapter Protection Circuit is included in the AC adapter. If the “High AC Input” lamp of the AC adapter is lit or the protection circuit in the AC adapter is tripped, this indicates that the incoming voltage is dangerously high and may cause injury or damage to the equipment, as mentioned above. When using an AC generator with AC output voltage of AC220-240V especially, Fujikura Ltd. recommends the following measures to correct the condition.
 1. Connect a step-down transformer between the generator and the AC adapter in order to lower the AC voltage from AC220-240V to AC100-120V.
 2. Or, use an AC generator with AC output voltage of AC100V.
 3. Or, use an AC generator that has an inverter circuit to stabilize the output.



Do not modify, abuse, heat or excessively pull on the supplied AC cord. The use of a damaged cord may cause fuming, electric shock or equipment damage and may result in personal injury, death or fire.



The splicer uses a three-prong (core) AC cord that contains an earthed ground safety mechanism. The splicer **MUST** be Grounded. Use only the supplied three-prong (core) AC power cord. **NEVER** use a two-prong (core) power cord, extension cable or plug.



Connect AC power cord properly to the splicer (inlet) and wall socket (outlet). When inserting the AC plug, make sure there is no dust or dirt on the terminals. Engage by pressing the female plug into the splicer (inlet) and the male plug into the wall socket (outlet) until both plugs are fully seated. Incomplete engagement may cause fuming, electric shock or equipment damage and may result in personal injury, death or fire.



Do not short-circuit the terminals of AC adapter and optional battery. Excessive electrical current may cause personal injury due to fumes, electric shock and equipment damage.



WARNINGS!



Do not touch the splicer, AC power cord and AC plugs with wet hands. This may result in electric shock.



Do not operate splicer near hot objects, in hot temperature environments, in dusty / humid atmospheres or when water-condensation is present on the splicer. This may result in electric shock, splicer malfunction or poor splicing performance.

When using optional battery, follow the instructions below.

Failure to follow these may result in explosion or personal injury.

- Do not charge battery with other methods than instructed.
- Do not discard battery into an incinerator or fire.
- Do not charge or discharge battery near a flame or under direct sunlight.
- Do not excessively shake or jar the battery.
- If battery leaks of liquid residue, be careful handling the battery so the liquid does not get in skin or eye contact. If it reaches contact, immediately wash skin or eyes thoroughly and see the doctor. Dispose of the battery and call the service center for replacement.
- Do not stack battery on top of AC adapter while charging.
- If charge did not complete in five hours or the "CHARGE" LED does not turn ON, immediately stop charging and call the service center for repair.



When transporting the carrying case using the shoulder belt, check the belt and hooks for damage before use. Carrying the case with a damaged shoulder belt may cause the belt to break or come off and result in personal injury or equipment damage.



CAUTIONS!



Do not store splicer in any area where temperature and humidity are extremely high. Possible equipment failure may result.



Do not touch protection sleeve or tube-heater during heating or immediately after completion of heating. Their surfaces are very hot and touching these may result in skin burn.



Do not place the splicer in an unstable or unbalanced position. The splicer may shift or lose balance, causing the unit to fall. Possible personal injury or equipment damage may result.



The splicer is precision adjusted and aligned. Do not allow the unit to receive a strong shock or impact. Possible equipment failure may result. Use supplied carrying case for transportation and storage. The carrying case protects the splicer from damage, moisture, vibration and shock during storage and transportation.



CAUTIONS!



Follow the below listed instructions for handling electrodes.

- Use only specified electrodes.
- Set the new electrodes in the correct position.
- Replace the electrodes as a pair.

Failure to follow the above instructions may cause abnormal arc discharge. It can result in equipment damage or degradation in splicing performance.



Do not use any chemical other than pure alcohol (99% or greater) to clean the objective lens, V-groove, mirror, LCD monitor, etc., of the splicer. Otherwise blurring, discoloration, damage or deterioration may result.



The splicer requires no lubrication. Oil or grease may degrade the splicing performance and damage the splicer.



The equipment must be repaired or adjusted by a qualified technician or engineer. Incorrect repair may cause fire or electric shock. Should any problems arise, please contact the authorized distributor.

RECYCLING and DISPOSAL

In European Union



In accordance with the European Parliament Directive 2002/96/EC, electrical parts and materials that can be re-used and/or recycled have been identified in order that the use of new resources and the amount of waste going for landfill can be minimised.

In the European Union, do not discard this product as unsorted municipal waste. Contact your local authorities.

In other countries

[Recycling]

To recycle this product, disassemble it first, sort each part separately by material components and follow your local recycling regulations.

[Disposal]

This product can be disposed of same as the standard electric products. Follow your local disposal regulations.

Introduction

This fusion splicer 12S is a fusion splicer which can connect a single optical fiber.

Moreover, a new function was added and made the 12S splicer much improved in versatility.

In order to master 12S, please read this instruction manual.



Splice mode

The 12S has not only standard splice modes, but also automatic modes, AUTO mode. The AUTO mode consists of [SM AUTO], [MM AUTO], [NZ AUTO], [DS AUTO] mode. When using AUTO mode, the automatic arc calibration function is enabled.

The standard modes consists of [SM] for SMF (ITU-T G652), [NZ] for NZDSF (ITU-T G655), [DS] for DSF (ITU-T G653) and [MM] for MMF (ITU-T G651). This mode requires executing [Arc Calibration] before splicing.

Automatic arc calibration function

This function calibrates the arc power at every splice. When the automatic arc calibration function is enabled, performing the [Arc calibration] function before a splice operation is not necessary. The automatic arc calibration function works in AUTO modes only. It doesn't work in the standard splice modes. When using those modes, performing [Arc calibration] before splicing is strongly recommended.

New function of 12S

Corresponds to connector splice

The connection of a field assembly optical connector by heating of a protection sleeve can be performed by a 12S.

Moreover, versatility is improved by portability.

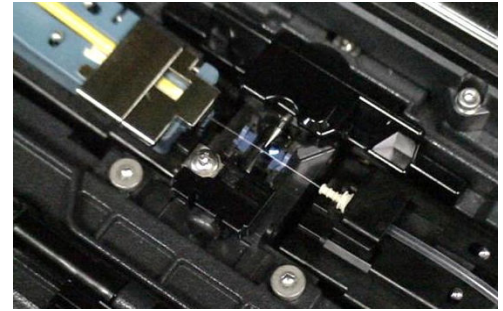

Corresponds to Short length splice

In addition to the standard splice, splice of 5-mm interference also recently became possible.



- A specialized tool is needed in order to perform 5-mm prepared.

Cleave Counter

The use situation of the optical fiber cleaver currently used for splice is displayed, and alarms, such as change of a cutting position and change of edge quantity, are displayed by a splicer on a plane. The large cleave angle and cleave shape NG at the time of fiber cutting, aggravation of a splice loss, etc. can be prevented in advance.

The optical fiber cleaver currently used when an alarm screen is displayed is adjusted.

Using of work tray

The work tray can be used immediately when removed from the inside of a main part storage carrying case can be used.

Moreover, the carrying case can be used as a working table.

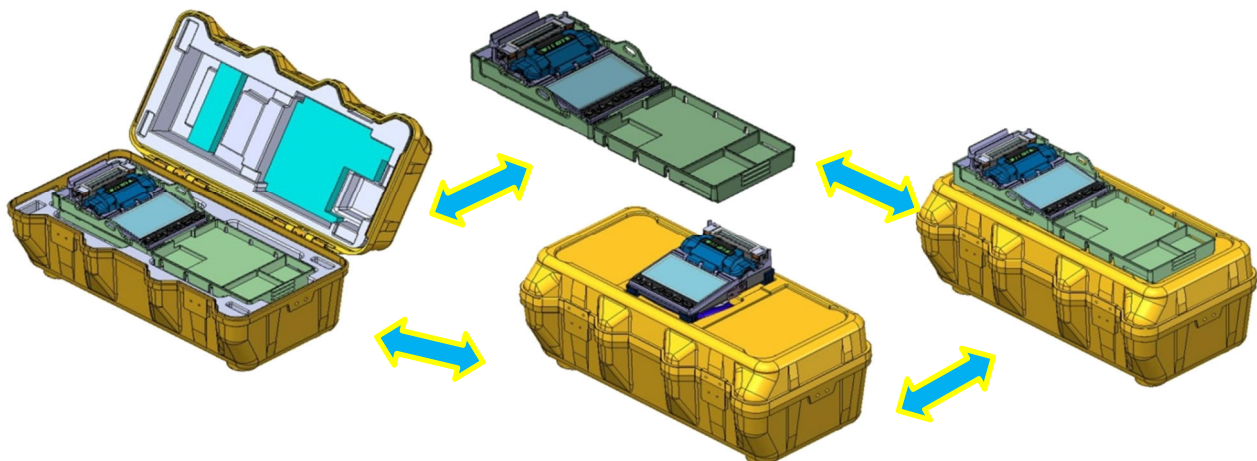

Upgrade of software

The software of 12S is upgradable from on the Internet.

Please install Data Connection in attached CD manual.



Components of Splicer

Standard Equipment

The standard equipment of the splicer is the following. Check the equipment items mentioned of list.

Standard Package List.

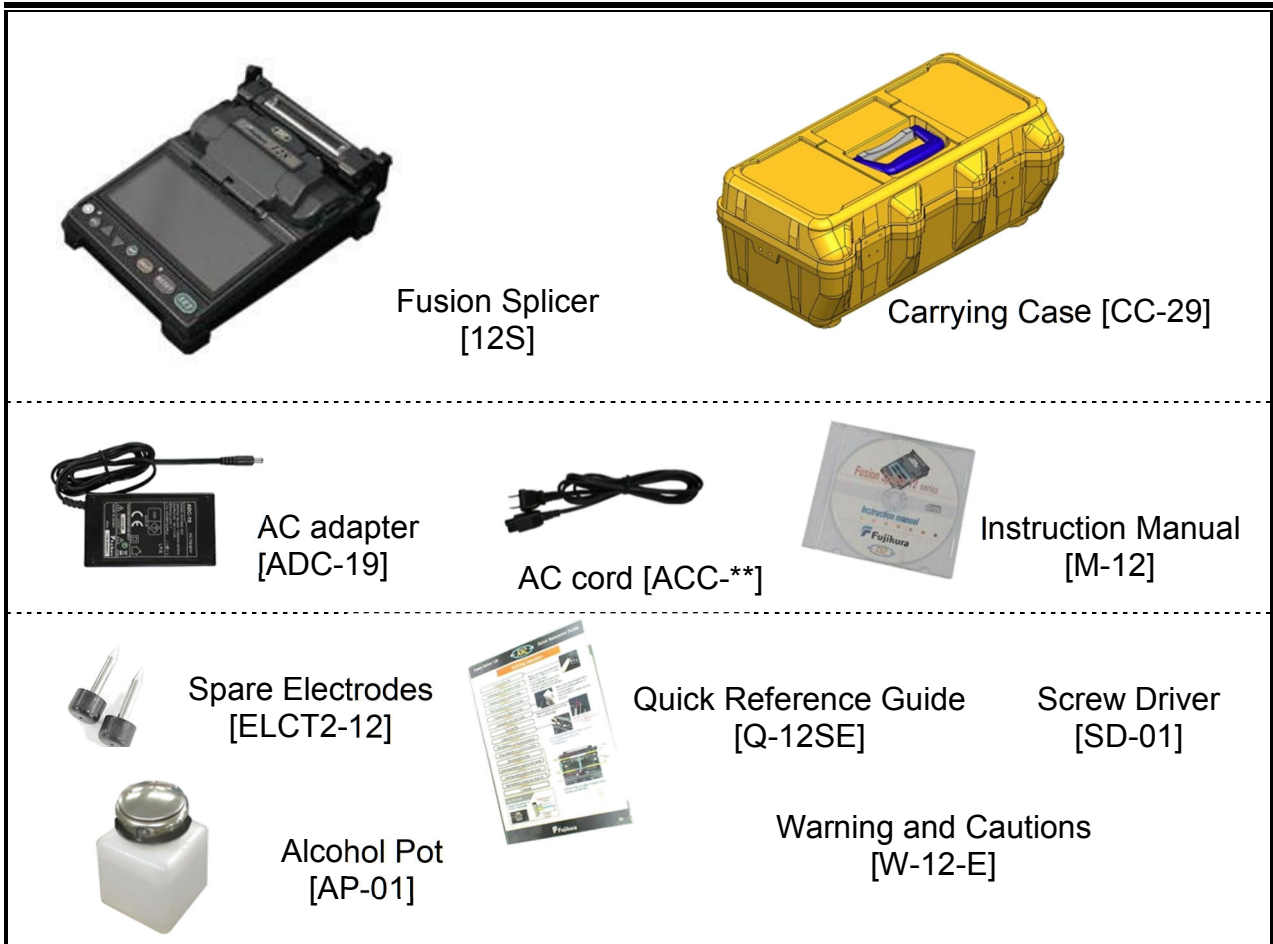

Option parts

Fiber Holder









For 250um coating
[FH-60-250]



For 900um coating
[FH-60-900]

Other Necessary Items for Splicing Operation

Tools

Fiber coating diameter	UV Coating 0.25mm	Ny Coating 0.9mm
Fiber protection sleeves	<u>Standard sleeve</u> 60mm length [FP-03] 40mm length [FP-03 (L = 40)]	
	<u>Micro sleeve</u> 15mm length [FPS01-400-15]	<u>Micro sleeve</u> 20mm length [FPS01-900-20]
Fiber stripping tools	Primary coat stripper [PS-02] 	Jacket stripper [JS-01] 
Fiber Holder (Option)	Fiber Holder [FH-60-250] 	Fiber Holder [FH-60-900] 
Fiber cleaving tools	Fiber Cleaver [CT-05] Cleave length : 10mm fixed (Coating 3mm + Glass 10mm)	
Fiber cleaning tools	Alcohol Pot [AP-01] with alcohol (purity > 99%) Lint-free tissue or gauze	

Description and Function of Splicer



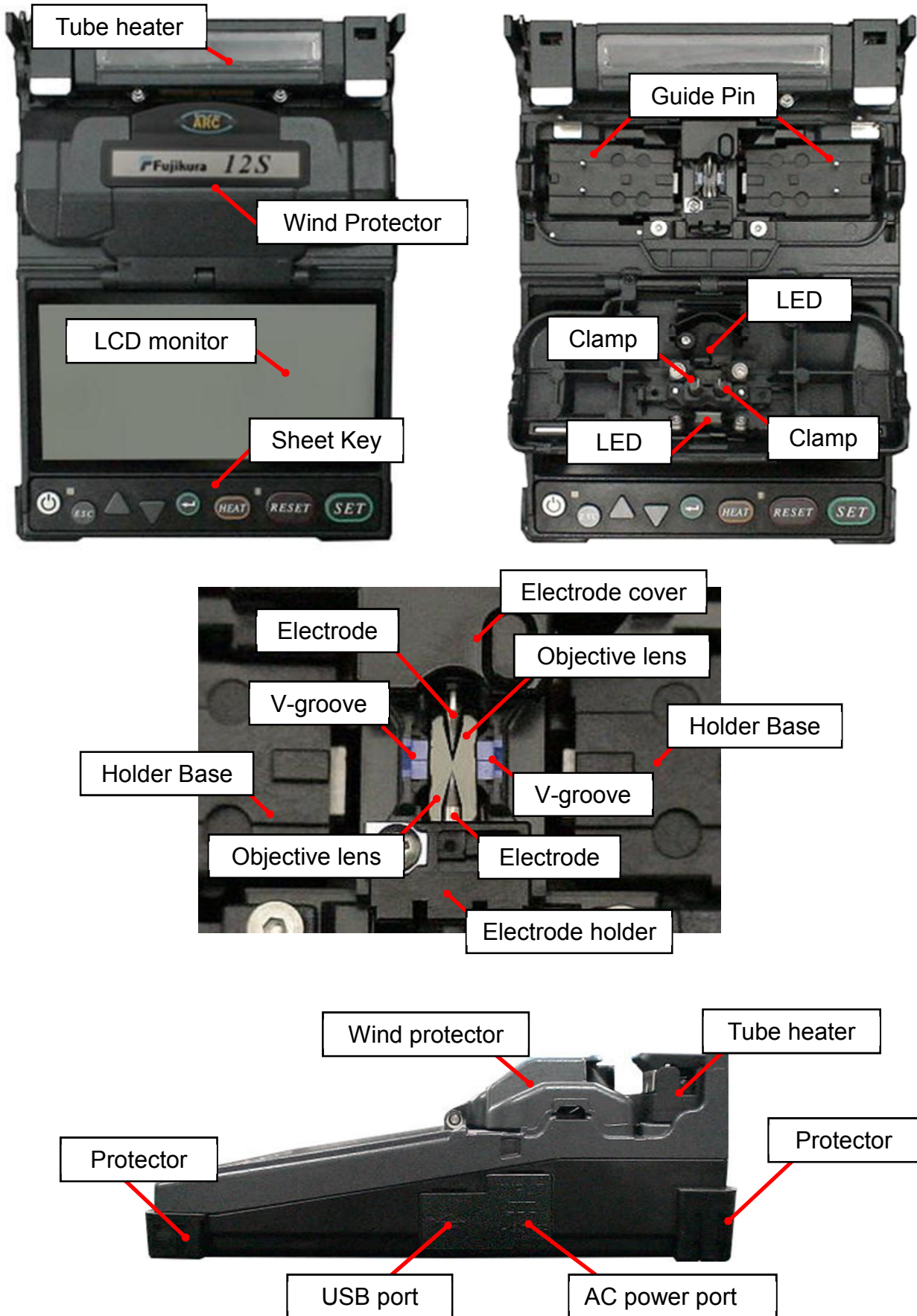



structure

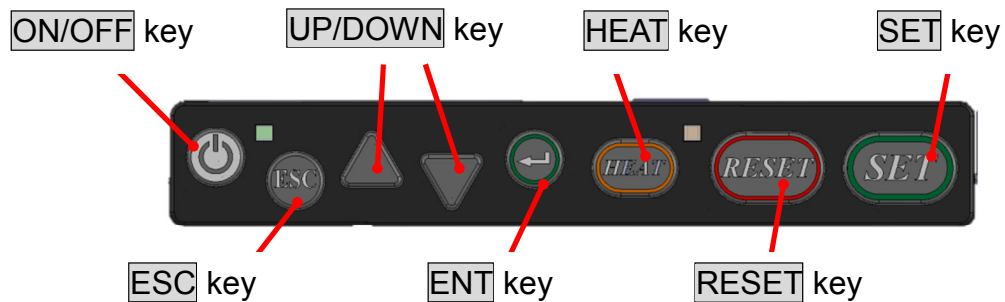

Operation of Sheet Key

The outline view of a sheet key



Key Symbol	Key Indicates Key Name	Key Function
	ON/OFF Power key	To turn ON/OFF the power.
	Up/Down Arrow Keys	To adjust the brightness of the monitor screen at the ready state. These arrows are used to move the cursor for selecting the items at the menu state, or to change the value or letter of the discharge conditions and comments. During manual motor control, these arrows serve as the "Backward" and "Forward" keys to operate the motors.
	HEAT Heat Key	To start the heating process by the tube heater.
	RESET Reset Key	To quit from any state except the heating process by tube heater. After pressing this key, the splicer will return to the ready state with a beep sound.
	ESC Escape Key	To change the X/Y view image and display the data at the "Ready", "Pause", "Finish" state. To quit from input data at the Menu state.
	ENT Enter Key	To open the menu at the "Ready" state. To select the command and decide the parameter at the menu state.
	SET Set Key	To start the splicing operation, or to go through to the PAUSE state. To move the cursor direction of arrow at menu state

Splicing work preparation

The space for working is secured. The work environment according to various uses can be made from using the carrying case of this equipment, and a work tray.

Use a work tray

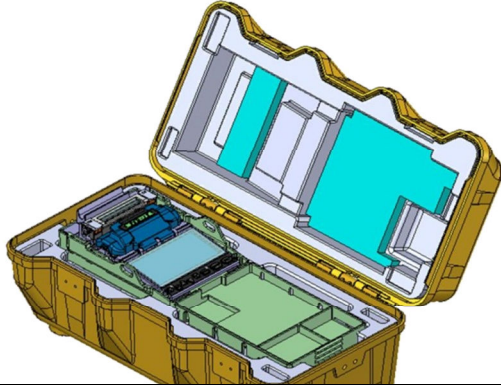

Where a carrying case lid is opened, work can be started immediately.

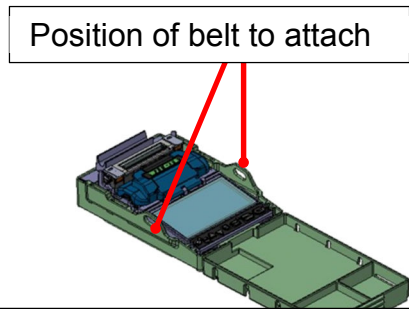

Position of belt to attach

If a work tray is taken out and a belt was used, it can work as a simple working table.

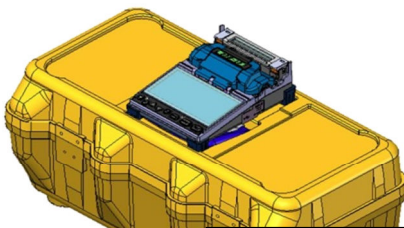

The carrying case itself can be used as a working table. Moreover, original work environment can be made from dividing a work tray.

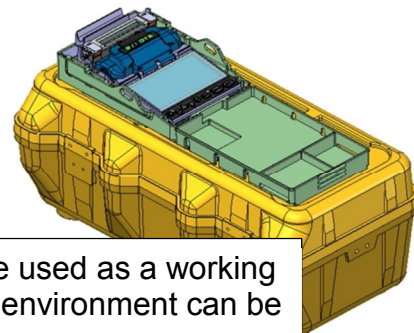

- Arrange safety belts/devices for equipment and accessories on the tray before use. In case the equipment/accessories were dropped to a person under operation area, this would result in serious injury or fatal accident.

In the case of use only with splicer

Use in a location which does not have vibration, a shock, etc. at the time of performing fusion splice work. In work [at the unstable place where a main part is shaky], the possibility of damage from a fall becomes high.

Power Supply

This section describes the procedures for using the power supply with the equipment. Splicer is operated with AC adapter (ADC-19) or the internal battery. Use the only external AC adapter (ADC-19) and AC Coad (ACC-**) with Splicer.



AC Adapter [ADC-19]



AC Coad [ACC-**]

AC Operation

Insert AC cord into the AC inlet of the AC adapter. The power ON LED of the AC adapter changes green color when suitable AC voltage is supplied. If high AC Voltage is supplied, the AC adapter will immediately be damaged.

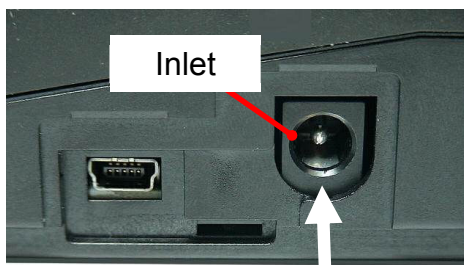

ADC-19



Insert

AC generators commonly produce abnormally high AC output voltage.

Measure the output AC voltage with a circuit tester before connecting the AC power cord. Such abnormally high voltage or frequency from a generator may cause fuming, electric shock or equipment damage and may result in personal injury, death or fire.

Notes: when using an AC adaptor BTR-10

If AC adaptor is used without battery pack BTR-10, some error may be occur. Please operate the splicer with battery pack BTR-10

Battery Operation

Check the remaining battery capacity. If it is 20% or less before operation, splicer can only work a few times.







- Keep below practices to prevent battery damage.
Fully charge the battery after every use.
Follow below conditions
- Operation : -10 degree C ~ 50 degree C
- Charging : 0 degree C ~ 40 degree C
- Storage : -20 degree C ~ 30 degree C

How to charge the battery

Charge of battery pack BTR-10 is started where AC adaptor ADC-19 is connected to an inlet. The charge LED (orange) blink and battery charging starts. It takes about 4 hours to charge the battery and the turn off the LED. Pull out the plug of AC power cord after charging. It is possible to use the splicer during operation.

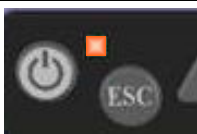

Charge will be started if a power supply is supplied from ADC-19.
Please check the charge state in main part sheet key LED.

	Power supply ON state	Power supply OFF state
Normal	 <p><u>LED : ON green</u> Check the battery capacity</p>	 <p><u>LED : OFF</u></p>
Charging	 <p><u>Battery mark operates</u> 4 hours to charge the battery</p>	 <p><u>LED:Blink orange</u> 4 hours to charge the battery</p>
	 <p><u>LED: Orange Blink quickly(OFF state)</u> Refer to *1</p>	

*1

When LED blinks at the time of charge it is too early and degradation of a battery and failure can be considered. Charge is not performed.
Exchange for New BTR-10.

How to check remaining battery capacity

Press **ON/OFF** key and hold it until the green LED turns on.



If splicer is already equipped with the battery, turn splicer ON. Power source of "Battery" is automatically identified and the remaining battery capacity is displayed on the "READY" screen.

READY screen

Remaining battery capacity display	Remaining battery
	95~100%
	65~95%
	40~65%
	15~40%
	Less than 15%

The battery residual quantity indicator on a screen is a near standard. When working in battery-operated, we recommend you to charge before work. The battery residual quantity indicator depends on the environmental condition and the degradation of battery life based on use.

The battery residual quantity indicator on a screen is only as a guide.



- In order to increase the number of fiber splices and times of heating, please change to a power-saving mode setup.

Replace the Battery pack



- When batteries are exchanged, be sure to work in the state of OFF of a power supply. If hot swapping is performed, failure of splicer or a battery will be caused.

1. Turn Off splicer. Two screws which have secured the battery cover of the bottom of a main part are loosened.

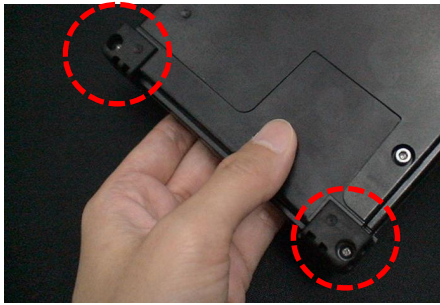

2. Battery cover is removed. The loosened screw portion is raised upwards and pulled to the front, and the batter connector is removed.

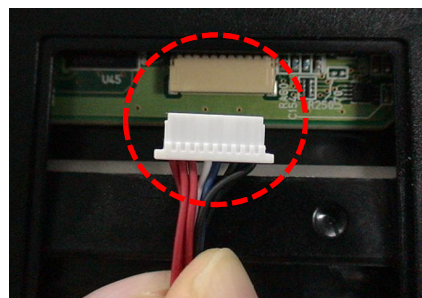
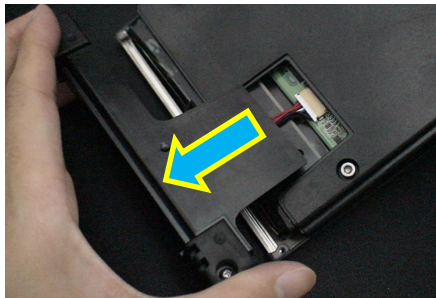

3. The main part of a battery pack is pulled out.



Insertion of a battery pack (BTR-10)

Be careful of battery attachment and attach it with reference to an attachment procedure.



Close a cover after attaching the portion which is the dotted line portion of a figure.

Turning Splicer ON/OFF

Turning Splicer ON

Press **ON/OFF** key and hold it until the green LED turns on. The following warning screen is displayed.



- The license message is displayed twice a month when the splicer is turn on.
- There is a possibility that a language is fixed depending on the country of shipment.

The READY screen is displayed after all the motors are reset to their initial positions when you select [Agree]. The power source type is then identified. If the battery is used, the remaining battery capacity is displayed.

Turning Splicer OFF

Press **ON/OFF** key and hold until the red LED turns off and then detach.

LCD Brightness adjustment

Monitor visibility changes depending on environmental conditions. To change monitor brightness, press **Up/Down** Arrow key to change value and press **ENT** key to set value.

The diagram shows two stages of the LCD screen. On the left, the screen displays "READY" at the top, followed by "Splice Mode SM AUTO" and "Heater Mode 60mmS FP-03". A yellow arrow points to the right, where the screen shows the "LCD Brightness" adjustment menu. This menu includes a vertical slider with values 10, 50, and 100, and options for "Change", "Apply", and "Cancel". Below the diagrams, a sequence of key presses is shown: "Up/Down Arrow key", "ENT key", and "Decided".

READY

READY

Splice Mode
SM AUTO

Heater Mode
60mmS
FP-03

How to operate

LCD Brightness

100
50
10

Change
Apply
Cancel

How to operate

Up/Down Arrow key

ENT key

Decided

Splicer Settings Check

Composition of a READY screen

Splice Mode

Select appropriate splicing mode for the specific fiber combination. Current mode is displayed on the READY screen.

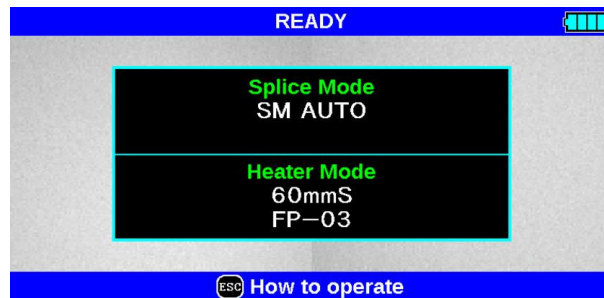

Heater Mode

Select appropriate heating mode for the specific protection sleeve used. Current mode is displayed on the READY screen.

Change of the Splice Mode

The optimal splice setting for a specific fiber combination consists of the splicing parameters listed below. In other words, the optimal splicing parameters depend on the fiber combinations, and are different depending on the fiber used.

- Parameters for controlling arc discharge.
- Parameters for calculating estimated splice loss.
- Parameters for controlling fiber alignment and splicing procedures.
- Threshold for error messages.

A series of optimal splice parameters for major fiber combinations are already stored in the splicer. These parameters are stored in the database area and can be copied to the user-programmable area. These splice parameters can be edited for a specific fiber combination.

➤ How to select the "Splice Mode"

[AUTO] and others

Use this mode if the fiber type is identified.



[SM] and others

Use this mode for splicing special fibers. This mode enables to set specific parameters for each splicing. Execute [Arc Calibration] before using this mode.

Splice Mode selection

Select an appropriate splice mode for type of fiber to be spliced.

1. Press **ENT** key at [READY], [PAUSE] or [FINISH] state to open [Splice Settings]. Select [Select Splice Mode] and the [Select Splice Mode] menu is displayed.
2. Move cursor by pressing **Up/Down** Arrow key and press **ENT** key to select [Splice mode].

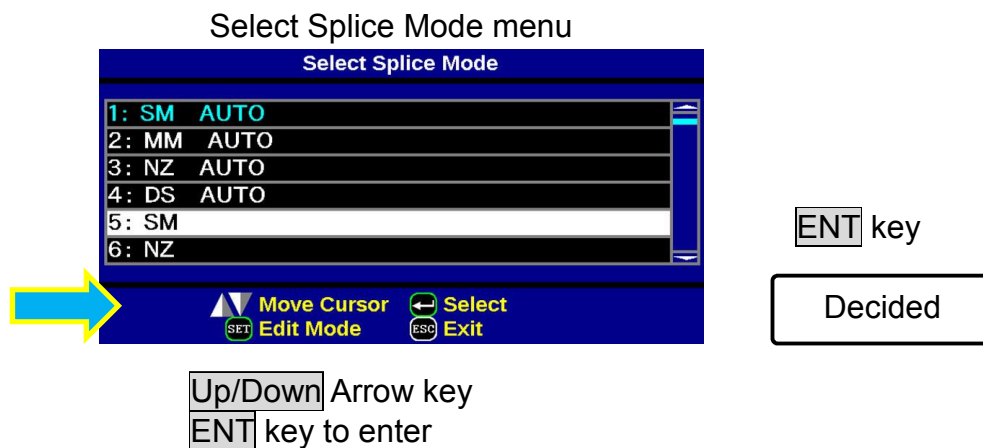
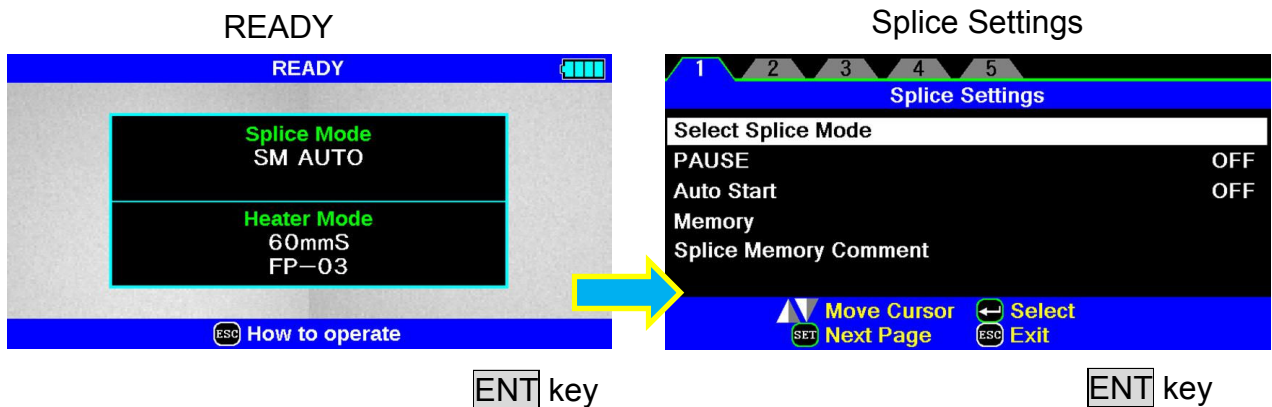

3. Splice Mode can be checked on a READY screen.

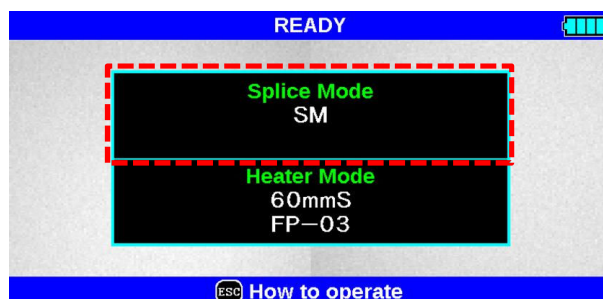

Select of the Heater Mode

Each tube-heating mode is optimized for a type of Fujikura protection sleeve. These modes can be found in database area for reference. Copy the appropriate one and paste it to the user-programmable area. The operator can edit the user-programmable modes.

Data Base

Parameter	Description
60mmS FP-03	For standard 60mm protection sleeve, Such as Fujikura FP-03 or FP-03M protection sleeves.
40mmS FP-03(L=40)	For standard 60mm protection sleeve, Such as Fujikura FP-03 or FP-03M protection sleeves. Note : Cleave length 8mm.
40mmR FP-04T	For standard 40mm protection sleeves, Such as Fujikura FP-03 (L=40).
15mmS FPS01-400-15	400 or less um of diameters of coating. Splice of the interference length of 5 mm or less
20mmS FPS01-900-20	900 or less um of diameters of coating. Splice of the interference length of 6 mm or less
60mmS FPS01-DC-60	For Splice of a drops cable.
28mmS FC-SC-**-30/20	For Fuse connect splice.
45mmS FC-SC-**-09	

The dimensions of the Protection Sleeve after heat shrink

Form	Tension member	Sleeve length	Prepare fiber length	Diameter of an adaptation optical fiber	Diameter of a result
FP-03	SUS	60mm	16mm or less	250~900um	3.1mm
FP-03(40mm)	SUS	40mm	10mm or less	250~900um	3.1mm
FP-04T	Glass ceramic	40mm	10mm or less	250~900um	4.0mm
FPS01-400-15	SUS	15mm	5mm or less	~400um	1.5mm
FPS01-900-20	SUS	20mm	6mm or less	~900um	2.3mm

* The dimensions of the protection sleeve after shrink are varied depending on the diameter of the fiber.

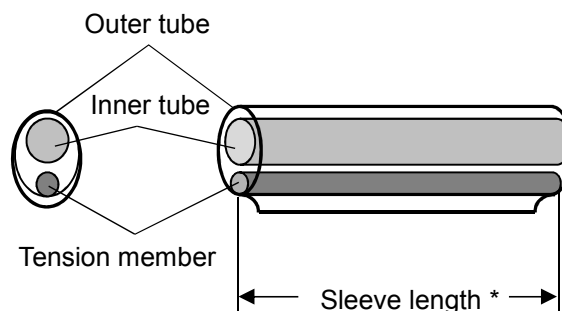

Selecting Heater mode

Select the heater mode most suitable for the protection sleeve to be used.

1. Press **ENT** key in [READY], [PAUSE], [FINISH] state and press **SET** key to display [Heater Menu].

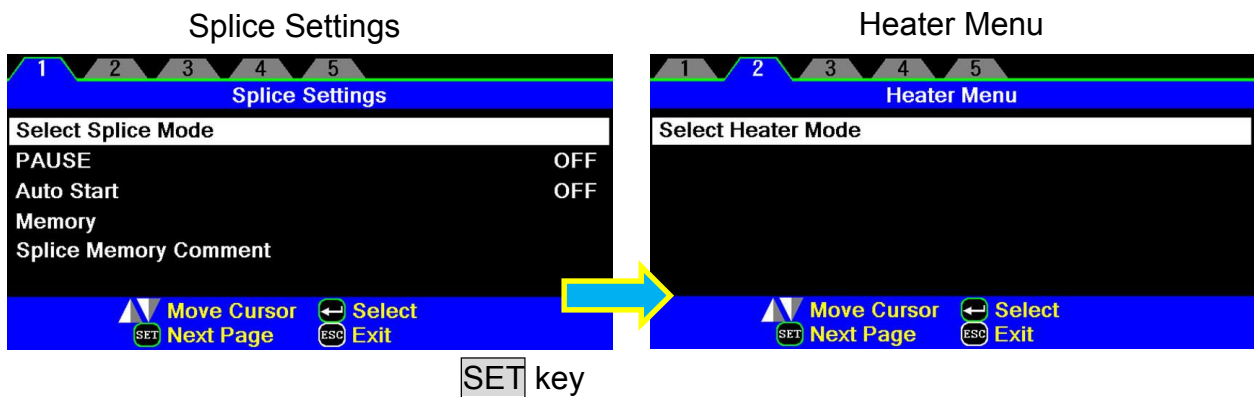

2. Select [Select Heater Mode] in [Heater Menu]. [Select Heater Mode] menu is displayed.
3. Move cursor by pressing **Up/Down** Arrow key and press **ENT** key to select a heater mode.

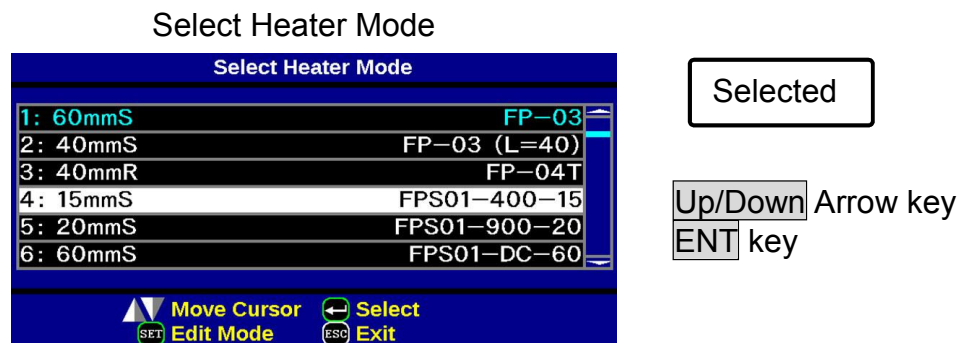

4. The check in the heater mode selected on the OK screen can be performed.

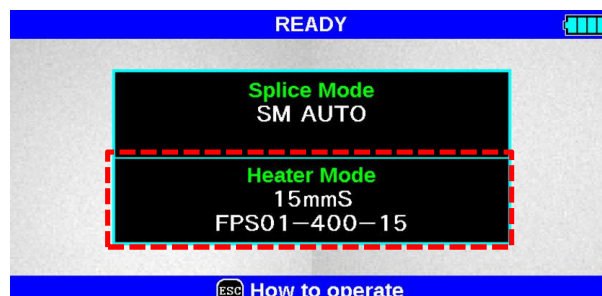

- When using a protection sleeve which is not made by Fujikura, please set parameters based on the specific sleeve.
- When the sleeve of another company is used, the durability of a protection point cannot be warranted.

Preparation of fiber

Cleaning optical fiber

Clean optical fiber with alcohol-moistened gauze or lint-free tissue approximately 500mm from the tip. Dust particulates from the fiber coating surface can enter inside the protection sleeve and might result in a future fiber break or attenuation increase.

Placing protection sleeve over fiber

Place the protection sleeve over the Right side fiber.



- Since a left hand serves as a standard at the time of fiber conveyance, the method of inserting a sleeve in a right-hand side fiber is recommended.

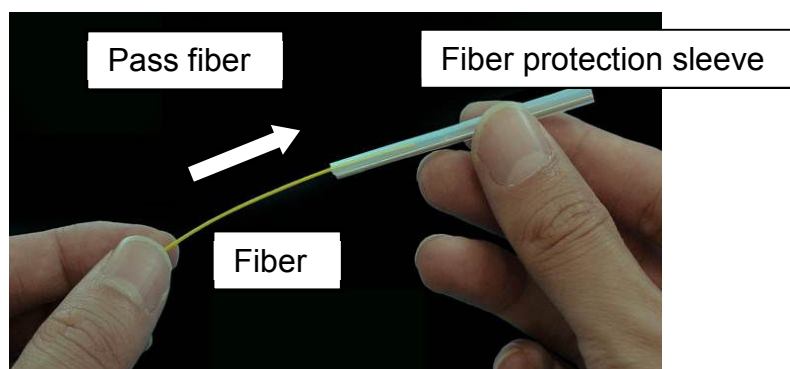

Fiber coating stripping and cleaning of bare fiber

Strip the outer coating 30 to 40 mm from fiber tip with a stripping tool. Clean the fiber with alcohol moistened gauze or lint-free tissue thoroughly. Frequently replace cleaning gauze to insure splice quality.

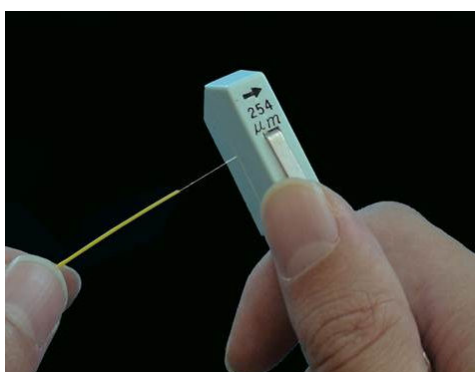

Stripping

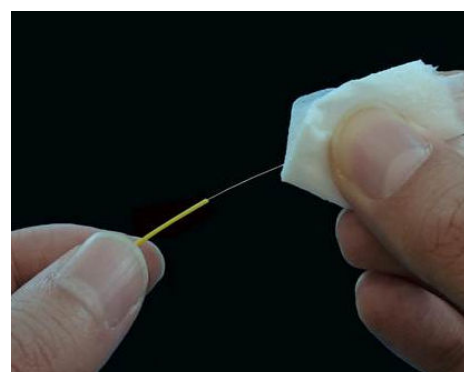
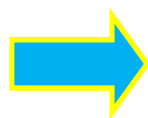

Cleaning



- Use a high quality alcohol, greater than 99% pure.

Set the fiber onto fiber holder

Set the fiber onto the fiber holder with the fiber sheath 3mm from the end of the fiber holder and then close the fiber holder lid.



- Close the lid of a fiber holder while pressing down with a finger on the coating (refer to figure below).
- Select a suitable fiber holder based on the fiber coating diameter.
- If fiber coating has some memory curl, place fiber so that the curve of memory is turned downwards.

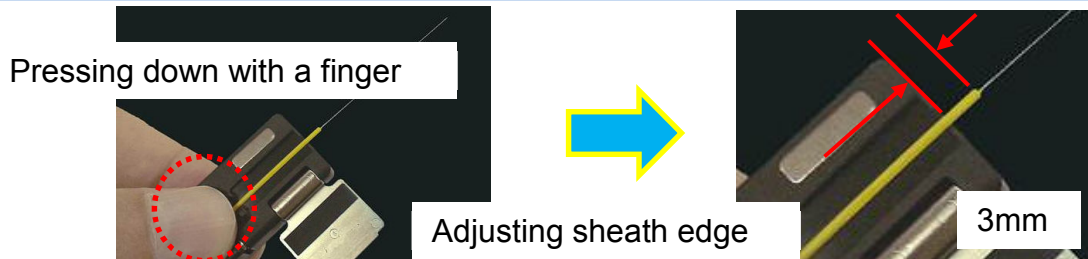

Fiber Cleaving

To unlock the cutting lever, press it gently and slide the stopper. Push the slide button until it locks and set the stripped optical fiber on the cleaver.

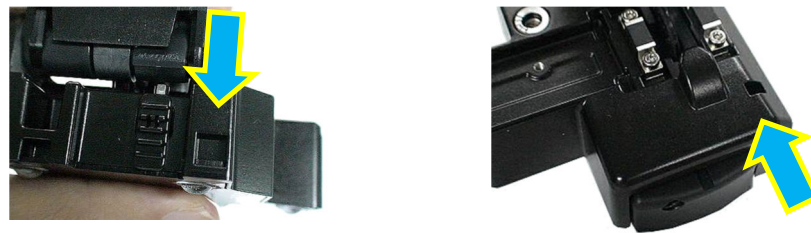

Press down the cutting lever. Release the pressure on the cutting lever. A spring force will bring it to its open position.



- Confirm the sheath of fiber is not on pad when fiber holder is used.

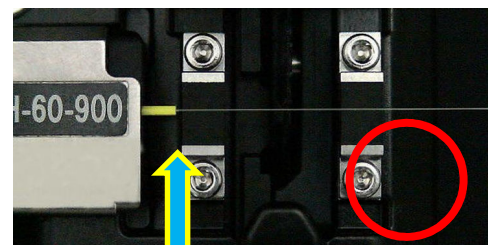
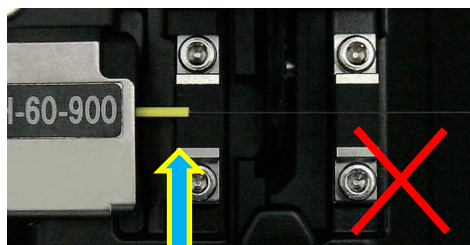

- Do not put fingers in the driving area of the slide button as personal injury may result.
- After pressing it only half way down, releasing the pressure on the cutting lever may result in bad cleaving quality.

Loading fiber to splicer

1. Open the wind protector.
2. Place fiber holders so that the guide pins on the stage go to guide-holes in the fiber.

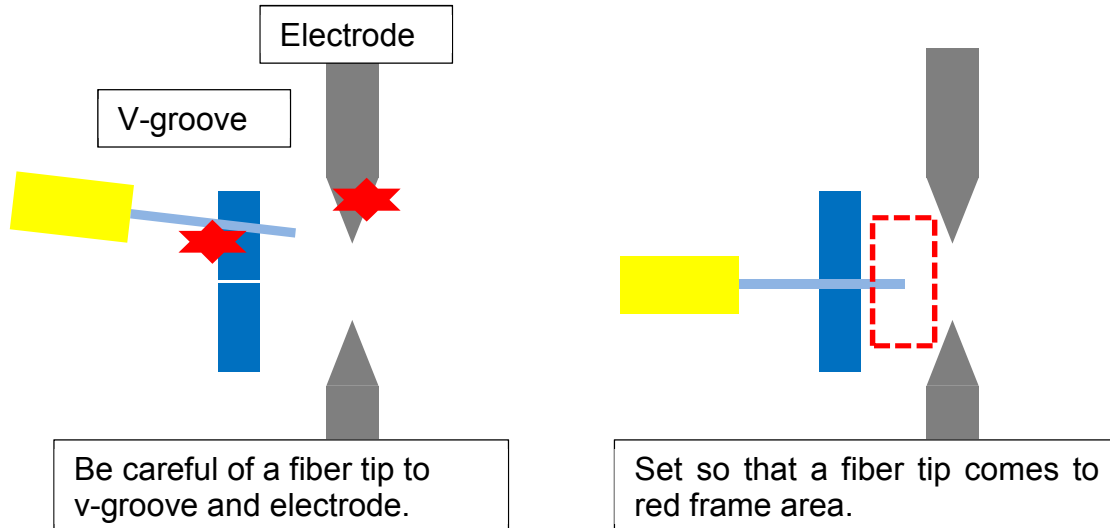
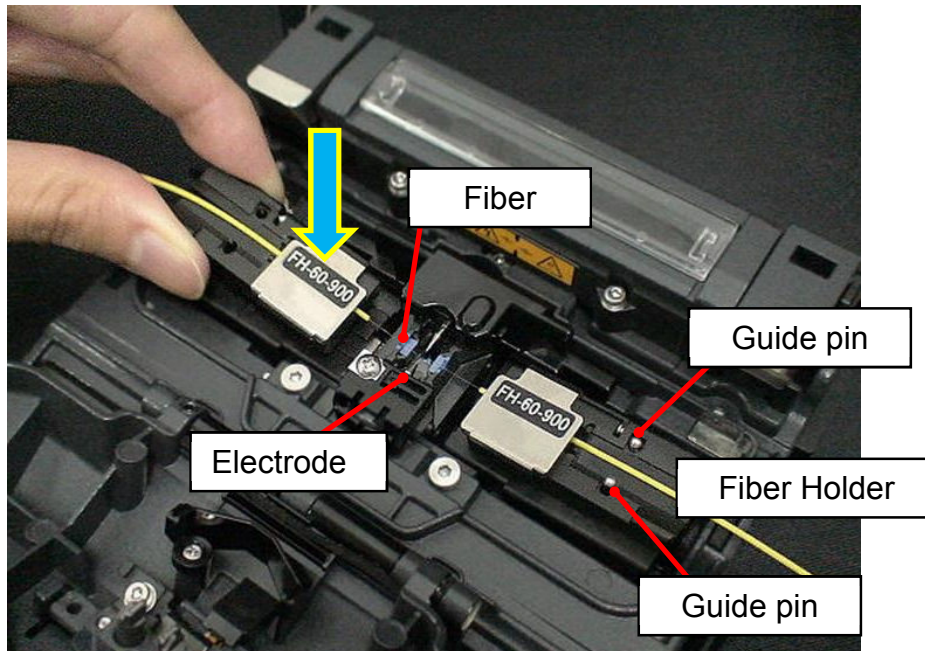

- Be careful not to contact the prepared fiber tips into anything to maintain fiber end-face quality.

3. Close wind protector. Although a splicing starts connection operation automatically, we recommend you to carry out an arc discharge inspection before splicing. Refer to the following clause for the Arc Calibration inspection point.

Arc Calibration

Atmospheric conditions such as temperature, humidity, and pressure are constantly changing, which creates variability in the arc temperature. This splicer is equipped with temperature sensor that is used in a constant feedback monitoring control system to regulate the arc power at a constant level. Changes in arc power due to electrode wear and glass adhesion cannot be corrected automatically. Also, the center position of arc discharge sometimes shifts to the left or right. In this case, the fiber splicing position has to be shifted in relation to the arc discharge center. It is necessary to perform an arc power calibration to eliminate both of these issues.



- Arc calibration is performed automatically using [AUTO] mode only. So arc calibration does not have to be performed when splicing in this mode.
- Execute [Arc calibration] before using non-auto mode.
- When Performing the [Arc Calibration] function change the arc power "factor" value. The factor value is used in the algorithm program for all splicing. The arc power value will not change in the splice modes.

Operation procedure

1. Select [Arc Calibration] in [Maintenance Menu 2] to display Arc Calibration screen.
2. Set prepared fibers onto the splicer.

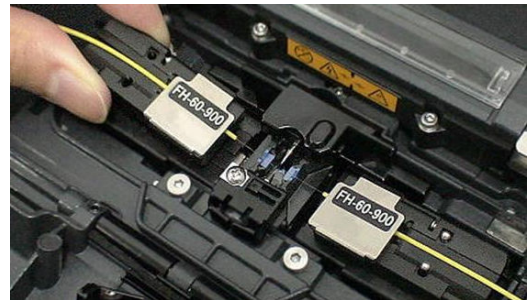
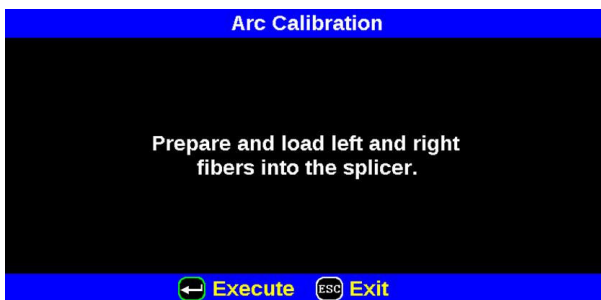

- Use standard SMF ITU-T G652 fiber for Arc Calibration.
- Use well prepared fibers for arc calibration. Dust on the fiber surface affects arc calibration.
- Cleave angle threshold does not link to the parameter "Cleave Limit" in splicing modes. Cleave angle threshold is independently set for arc calibration. See section [Maintenance Settings] to change cleave angle threshold.

3. The ARC Calibration after pressing **ENT** key.

“Good” message

Arc power and splicing position calibration are successfully completed. Press **ESC** key to exit.

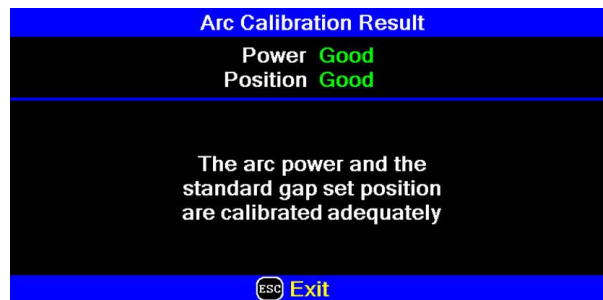

Result: Good

“Not Adequate” message

Arc power and splicing position calibration are completed but further calibration is strongly recommended, as the change from the previous arc calibration is too large. Press **ENT** key to perform arc calibration, or **ESC** key to exit even though arc calibration is not completed.

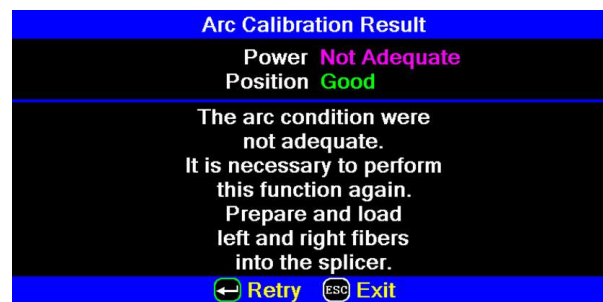

Result: Not Adequate



- In some cases, multiple iterations of arc calibration are needed until the calibration process is successfully completed and the "Test Finish" message is displayed. Arc calibration can be considered almost completed if multiple iterations are completed without receiving the message.
- Number threshold can be set so that "Test Finish" message is displayed after specific number of arc calibrations is performed. See section [Maintenance Settings] for detail.

Splicing procedure

To make a good splice, the optical fiber is observed with the image processing system equipped in the 12S. However, there are some cases when the image processing system cannot detect a faulty splice. Visual inspection with the monitor is often necessary for better splicing yield. The instruction below describes standard operating procedure.



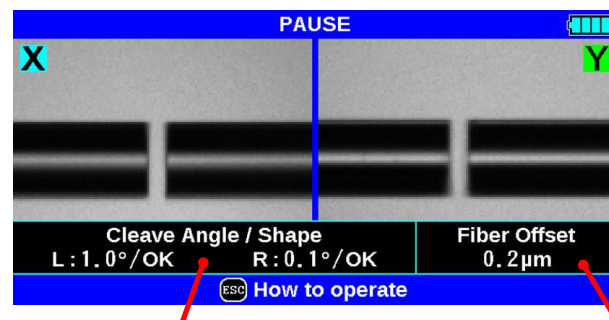

1. Fibers loaded in the splicer move forward toward each other. The fiber forwarding motion stops at a certain position shortly after the cleaning arc is performed.
2. Next, the cleave angle and end-face quality are checked. If the measured cleave angle is greater than its set threshold or fiber chipping is detected, the buzzer will sound and an error message warns the operator.



Left and Right cleave angle

Offset

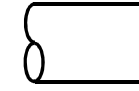
3. If no error message is displayed, the below stated end-face conditions are used for visual inspection. If observed, remove the fiber from the splicer and repeat fiber preparation. These visual defects may cause a faulty splice.

Cleave Shape NG		Large Cleave Angle	
			
Chip	Lip		Angle



- Pause after cleave angle check and fiber alignment can be set “disabled”. See section [Splice Settings] for detail.
- The cleave angle threshold can be changed. See section [Splice Menu]
- The cleave angle error message can be ignored by pressing **SET** key to go on to the next step. To disable the cleave angle error. See section [Splice Settings] for detail.
- Cleave angle, during the splicing operation can be hidden. See section [Splice Settings] for detail.

4. Cladding axis offset measurements can be displayed and after completion of arc discharge is performed to splice the fibers.
5. Estimated splice loss is displayed upon completion of splicing. Splice loss is affected by certain factors stated. These factors are taken into account to calculate, or estimate, splice loss. The calculation is based on certain dimensional parameters, such as MFD.

If either the cleave angle measured or the estimated splice loss exceeds its set threshold, an error message is displayed. If the spliced fiber is detected as abnormal, the "Fat", "Thin" or "Bubble" error message is displayed.

If no error message is displayed but the splice looks poor by visual inspection through the monitor, it is strongly recommended to repeat the splice from the beginning.

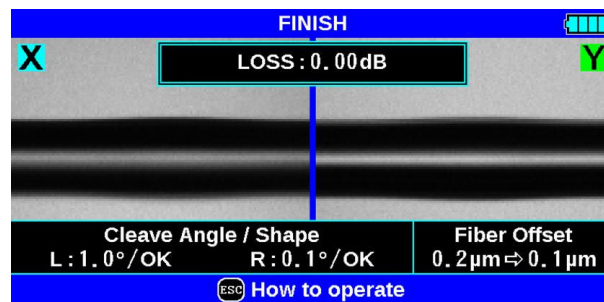

Splice loss may be improved in some cases by additional arc discharges. Press **SET** key for an additional arc discharge (re-arc). Splice loss estimate and splice check are performed again.









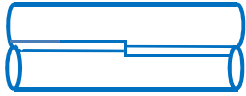

- Restriction of the number of times of additional arc discharge can be set up. Since excessive additional arc discharge becomes the cause of worsening splice intensity and a splice loss, it can forbid the arc discharge more than the suitable number of times. Refer to [Setting Menu] for details.

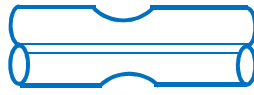

- Splice point sometimes looks a bit fatter than other parts. This is considered a normal splice, and does not affect splice loss.
- To change threshold for estimated splice loss or fiber angle, see section [Splice Mode].
- Error messages, such as "Estimated splice loss", "Splice angle", "Fat", "Thin" and "Bubble" can be ignored. This function can be set to "disabled". See section [Splice Settings] for detail.

Splice loss increase: Cause and remedy

Symptom	Cause	Remedy
Axial offset 	Dust on v-groove or fiber clamp chip	Clean v-groove and fiber clamp chip.
Fiber angle 	Dust on v-groove or fiber clamp chip	Clean v-groove and fiber clamp chip.
	Bad fiber end-face quality	Check if fiber cleaver is well conditioned.
Combustion 	Bad fiber end-face quality	Check the cleaver
	Dust still present after cleaning fiber or cleaning arc.	Clean fiber thoroughly or Increase [Cleaning Arc Time]
Bubbles 	Bad fiber end-face quality	Check if fiber cleaver is well conditioned.
	Prefuse power too low or prefuse time too short.	Increase [Prefuse Power] and/or [Prefuse Time].
Separation 	Fiber stuffing too small	Perform [Motor Calibration]
	Prefuse power too high or prefuse time too long.	Decrease [Prefuse Power] and/or [Prefuse Time].
Fat 	Fiber stuffing too much	Decrease [Overlap] and perform [Motor Calibration].
Thin 	Arc power not adequate	Perform [Arc Calibration].
	Some arc parameters not adequate	Adjust [Prefuse Power], [Prefuse Time] or [Overlap].
Line 	Some arc parameters not adequate	Adjust [Prefuse Power], [Prefuse Time] or [Overlap].



- A vertical line sometimes appears at the splice point when MM fibers or dissimilar fibers (different diameters) are spliced. This does not affect splice quality, such as splice loss or tensile strength.

Storing splicing results

Splicing results is stored in memory.



- After the 2000th result is stored, 2001st splice result is written over 1st result.

Storing results automatically

The splice result is automatically stored in memory when **RESET** is pressed upon completion of the splice at the [Finish] screen or when the wind protector is opened upon completion of the splice at the [Finish] screen.

Once a certain comment is recorded, the same comment is recorded into subsequent splice results. To change comments, see the next paragraph.

How to input Mode Title/Comment/Password

Character list below is displayed by selecting Mode Title / Comments / Password.

1. Move the cursor by pressing **Up/Down** Arrow key, **SET** key, and press **ENT** key to input the selected character. If an incorrect character is inputted, move the cursor to [BS] and press **ENT** key to highlight the character, and then input the proper character over it.
2. Move cursor to [ENTER] on left side and press **ENT** key on completion of inputting characters.
3. In the case of Password input, the next screen image is displayed if the correct password is inputted. If the input password is incorrect, the previous screen image is displayed.



CAPS Characters



SMALL Characters

Fiber Proof Test

The strength of the splice point can be checked. When finished press **RESET** or open wind protector and fiber proof test will be performed.



Removing spliced fiber

1. Open lid of wind protector and tube heater.
2. Hold left fiber with left hand at the edge of splicer and open left fiber holder lid.
4. Open right fiber holder lid.
5. Place the protection sleeve over the Right side fiber to splice point.
6. Hold right fiber with right hand, and remove spliced fiber from the splicer.

Hold left fiber with left hand at the edge of the splicer.

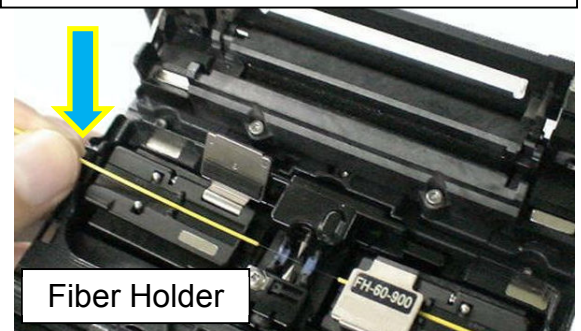

- Keep holding fiber until fiber is completely transferred to tube heater.

Insertion of the protection sleeve

A protection sleeve is moved to a splice point, holding a fiber with the left hand. It prevents slack from occurring at a splice point. Moreover, there is a possibility of fracturing if an excessive tension starts.



- Check that the splice point is located in the center of a protection sleeve.
- Check whether the twist has occurred on the right-and-left fiber.
- A tension member is designed to rest below a splice point.

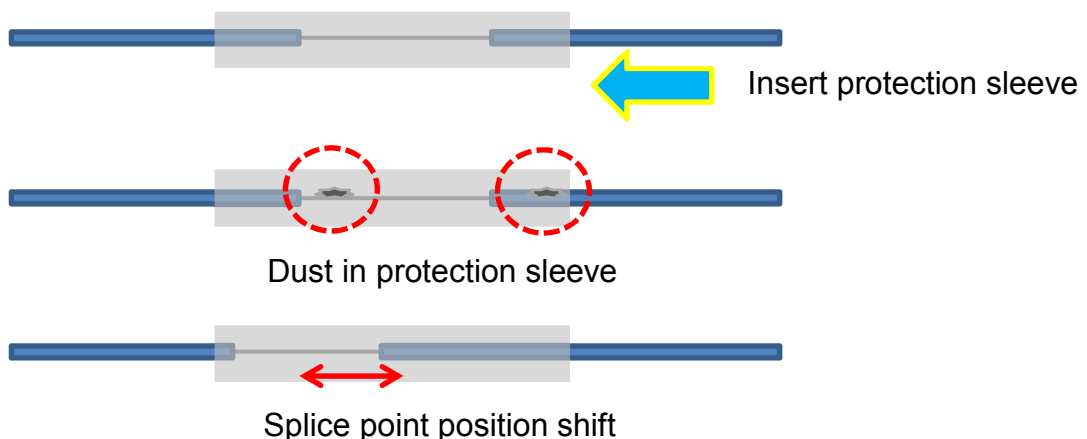

Heating protection sleeve

1. Transfer fiber with protection sleeve to tube heater.



- Make sure the splice point is located at the center of the protection sleeve.
- Make sure the strength member in the protection sleeve is placed on bottom.

2. Place fiber with protection sleeve in tube heater. Pressing the clamp pin with the fiber makes the lid closed.

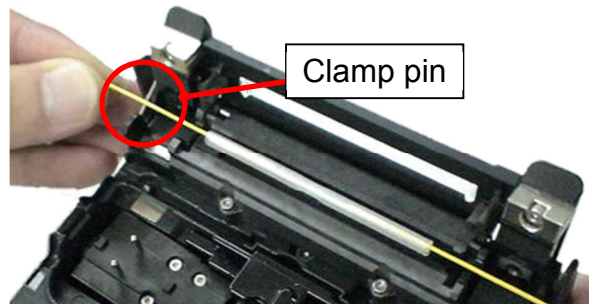

3. Press the **HEAT** key .Then HEAT LED turns on.



- If **HEAT** key is pressed during tube heating, the HEAT LED blinks. If **HEAT** key is pressed again, the tube heating process is aborted.

The buzzer beeps and the HEAT LED (orange color) turn off when tube heating is completed.

4. Open tube heater lids and remove protected fiber from the tube heater. Apply some tension to the fiber while removing it from the tube heater.



- Protection sleeve may stick to bottom plate of heater. Use a cotton swab to help remove sleeve from heater.
- Since it gets very hot in the heater and the sleeve will get hot, you should not touch the sleeve immediately after heating.

5. Visually inspect the finished sleeve to verify no bubbles or debris/dust is present in the sleeve.

Cleaning and Checking before Splicing

It is possible to maintain the performance of the splicer for a long time with proper cleaning and maintenance.

Critical cleaning points and maintenance checks are described below.

Cleaning V-grooves

If contaminants are present in the V-grooves, proper clamping may not occur, resulting in higher splice loss. The V-grooves should be frequently inspected and periodically cleaned during normal operation. To clean the V-grooves do the following:

1. Open the wind protector.
2. Clean the bottom of the V-groove with an alcohol-moistened thin cotton swab. Remove excess alcohol from the V-groove with a clean dry swab.

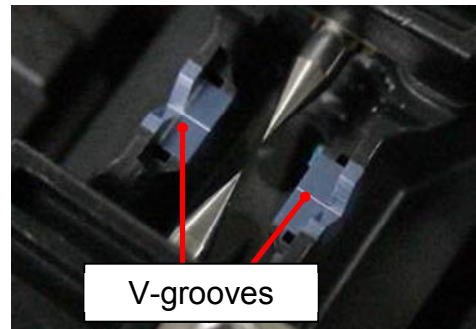

- Be careful to not contact the electrode tips.

3. If the contaminants in the V-groove cannot be removed with an alcohol-moistened thin cotton swab, use a cleaved fiber end-face to dislodge contaminants from the bottom of the V-groove. Repeat step section 2 after this procedure.

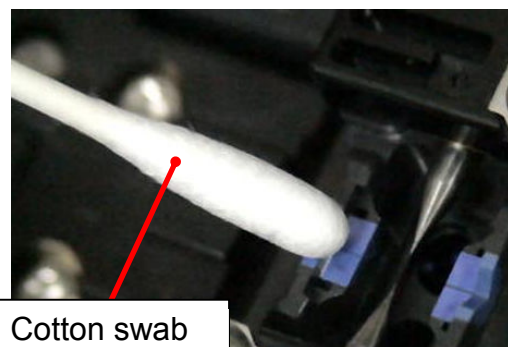
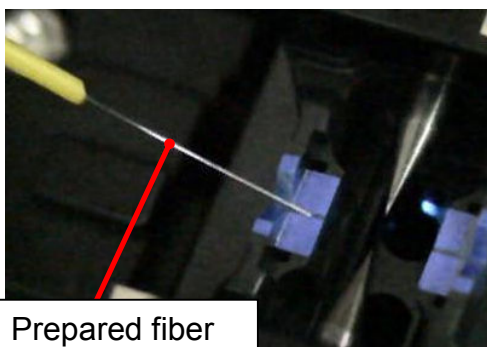

Cleaning Fiber Clamp Chips

If contaminants are present on the clamp chips, proper clamping may not occur, resulting in poor quality splices. The fiber clamp chips should be frequently inspected and periodically cleaned during normal operation. To clean the clamp chips do the following:

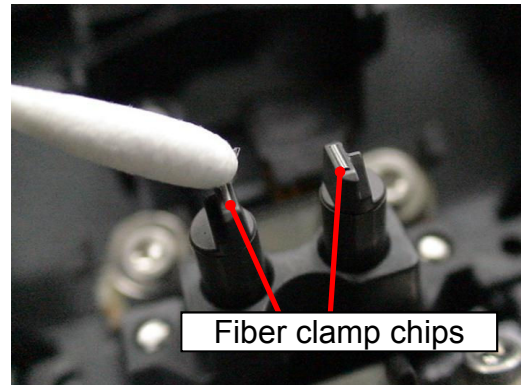

1. Open the wind protector.
2. Clean the surface of the chip clamp with an alcohol-moistened thin cotton swab. Remove excess alcohol from the chip clamp with a clean dry swab.

Cleaning Fiber Cleaver of CT-05

If the circular blade or clamp pads of the fiber cleaver become contaminated, the cleaving quality could degrade. This may lead to fiber surface or end-face contamination, resulting in higher splice loss. Clean the circular blade or clamp pads with cotton swab moistened with alcohol.

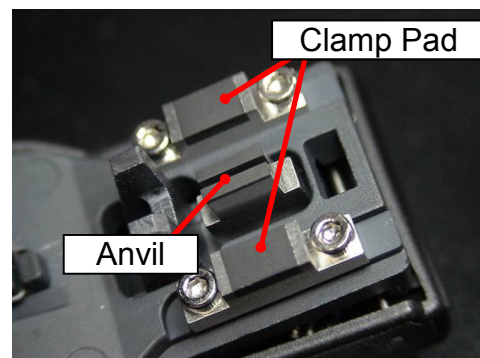
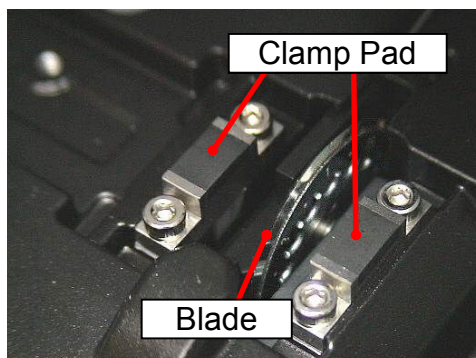

Arc Calibration

See Section [Maintenance Menu].

Periodical Checking and Cleaning

In order to maintain the splicing quality of the splicer, periodical inspection and cleaning are recommended.

Cleaning of Objective Lens Cover

If the surface of the objective lens cover becomes dirty, inaccurate observation of the fiber position may occur, resulting in higher splice loss or poor splicer operation. Therefore, clean objective lens cover. Otherwise, dirt may accumulate and become impossible to remove. To clean the objective lens cover, do the following:

1. Before cleaning the objective lens cover, always turn off the splicer.
2. Gently clean the lens cover with an alcohol-impregnated thin cotton swab. Remove excess alcohol from the lens cover surface with a clean dry swab.



- Remove electrodes before cleaning objective lens.
- Do not hit or touch the tip of the electrode when cleaning.

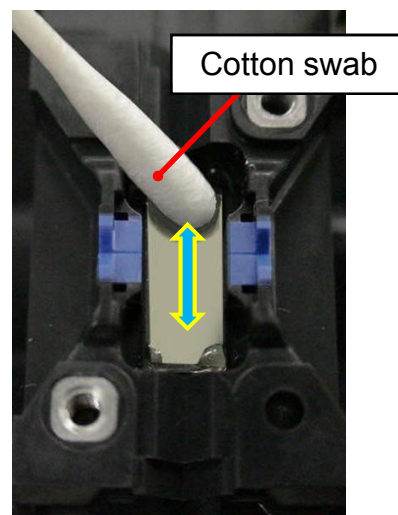
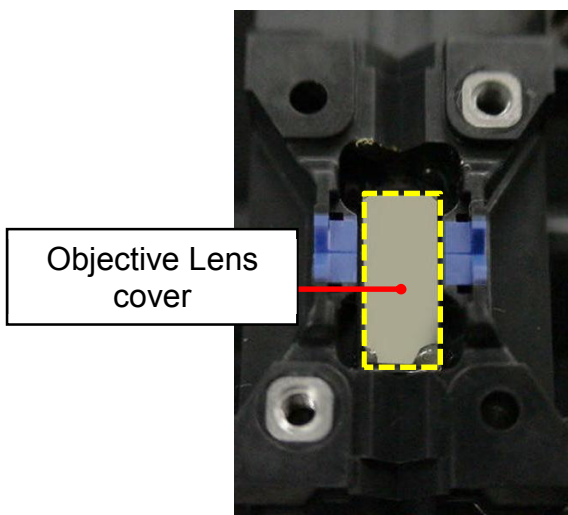

3. The lens cover surface should be clean and free of streaks or smudges.
4. Turn on the power and make sure no smudges or streaks are visible on the monitor screen. Perform the Dust Check procedure.

Rotating CT-05 Cleaver Blade

If the cleaver does not cleave properly, rotate the blade 1/16th of a turn to replace the worn out blade position with a sharp blade position. Blade life is normally 1000 cleaves per blade position. To rotate the blade, do the following:

1. Push the slide button until it locks. Using a 1.5mm hex wrench, loosen the blade lock screw.

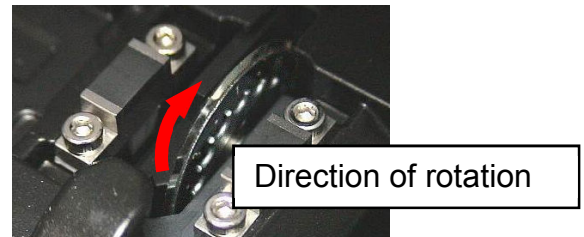
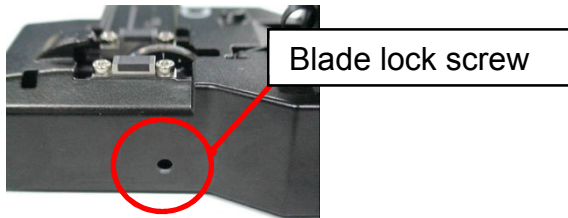

2. Rotate the circular blade 1/16th of a turn.
3. Tighten the blade lock screw.



- When rotating the blade, do not touch the cutting edge. Move the blade with a thin cotton swab, for easy and safe rotation.

Blade Height Adjustment

After the circular blade has been rotated a complete revolution (16 positions), its height needs to be adjusted to compensate for the wear.

1. Push the slide button until it locks. Using a 1.5mm hex wrench, loosen the blade lock screw
2. Using a 1.5mm hex wrench, loosen the adjuster lock screw.
3. Using a 1.5mm hex wrench, turn the adjuster clockwise so that the reference dot aligns with the next position mark. Never attempt to rotate the adjuster more than 2 position marks.
4. Tighten the adjuster lock screw.



- After blade height adjustment, the 16 blade positions can be used again. If the cleaver does not cleave properly, rotate the blade.

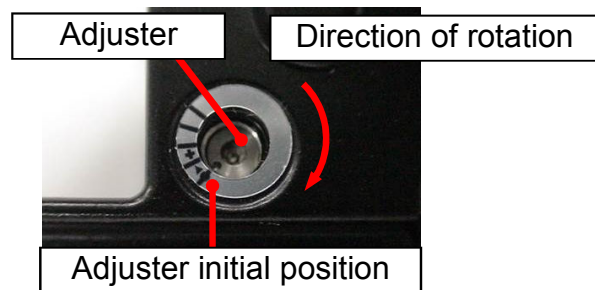
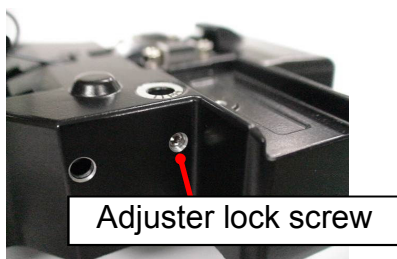

Blade Replacement

After the circular blade has been raised 2 times and rotated through all 3 positions (a total of approximately 48,000 fiber splices), it needs to be replaced. Contact the authorized distributor.

Replace Electrodes

See Section [Replace Electrodes].

Diagnostic Test

See Section [Diagnostic Test].

Splice Settings

Common parameters for all the modes for splicing and machine setting can be set.

1. Press **ENT** key at [READY], [PAUSE] or [FINISH] state to open [Splice Settings].
2. Move cursor by pressing **Up/Down** Arrow key to a parameter to be selected.
3. Press **ENT** key to change values and settings.

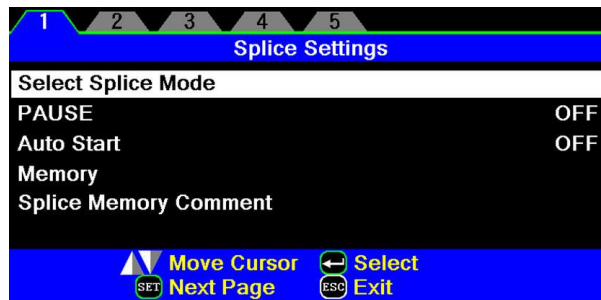

Setting parameters

Parameter	Description
Select Splice Mode	Mode according to the fiber to splice can be chosen.
PAUSE	If "Pause" is set to "ON", splicing operation pauses when fibers are forwarded to gap-set position. Cleave angles are displayed during the pause.
Auto Start	If "Auto Start" is set to "ON", splicing starts automatically as soon as the wind protector is closed. Fibers should be prepared and placed into the splicer in advance.
Memory	A situation can be checked after splicing with this machine.
Splice Memory Comment	A comment can be added to the memory saved at the time of the end of connection.

Splice Mode

The optimal splice setting for a specific fiber combination consists of the splicing parameters listed below. In other words, the optimal splicing parameters depend on the fiber combinations, and are different from fiber to fiber.

- Parameters for controlling arc discharge.
- Parameters for calculating estimated splice loss.
- Parameters for controlling fiber alignment and splicing procedures.
- Threshold for error messages.

A series of optimal splice parameters for major fiber combinations are already stored in the splicer. These parameters are stored in the database area and can be copied to the user-programmable area. These splice parameters can be edited for a specific fiber combination.

➤ How to select the "Splice Mode"

[AUTO] and others

Use this mode if the fiber type is identified.



[SM] and others

Use this mode for splicing special fibers. This mode enables to set specific parameters for each splicing. Execute [Arc Calibration] before using this mode.

Below is a figure showing the Arc discharge conditions (relationship between "Arc power" and "Motor motion"). The conditions can be edited by changing the splicing parameters listed below. Depending on splice mode, certain parameters cannot be changed.

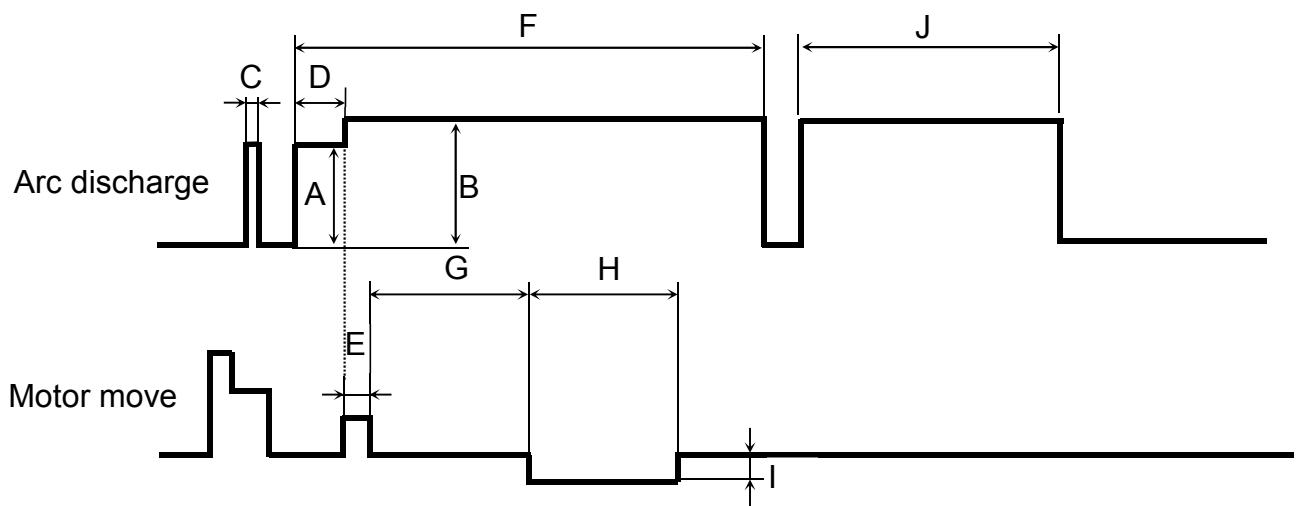

A: Prefuse Power,
D: Prefuse Time,
G: Taper Wait Time,
I: Taper Speed,

B: Arc Power,
E: Overlap,
H: Taper Time related to Taper Length,
J: Rearc Time

C: Cleaning Arc
F: Arc Time

Select Splice Mode

Database of splice mode

Splice Mode	Description
SM AUTO	This splice mode can splice the standard SM fiber (ITU-T G.652). The amount of heat applied to the fiber is calibrated in real time by analyzing the cladding illumination during arc discharge then adjusting The arc current accordingly. This splice mode does not require the operator to perform an arc calibration.
MM AUTO	This splice mode can splice the standard MM fiber (ITU-T G.651). The amount of heat applied to the fiber is calibrated in real time by analyzing the cladding illumination during arc discharge then adjusting The arc current accordingly. This splice mode does not require the operator to perform an arc calibration.
NZ AUTO	This splice mode can splice the standard NZDS fiber (ITU-T G.655). The amount of heat applied to the fiber is calibrated in real time by analyzing the cladding illumination during arc discharge then adjusting the arc current accordingly. This splice mode does not require the operator to perform an arc calibration.
DS AUTO	This splice mode can splice the standard DS fiber (ITU-T G.653). The amount of heat applied to the fiber is calibrated in real time by analyzing the cladding illumination during arc discharge then adjusting the arc current accordingly. This splice mode does not require the operator to perform an arc calibration.
AUTO SM/NZ/DS	This splice mode can splice standard telecommunications grade fiber, including SMF (ITU-T G.652), NZDSF (ITU-T G.655) and DSF (ITU-T G.653). The amount of heat applied to the fiber is calibrated in real time by analyzing the cladding illumination during arc discharge and adjusting the arc current accordingly. This splice mode does not require the operator to perform an arc calibration.

Points to note: of AUTO SM/NZ/DS mode



- NZDS is specified using the splicing mode for standard NZDS fiber. However, for best results, it is recommended that the optimum splice mode be selected for a specific type of NZDS fiber. This is due to the variation in the NZDS fiber properties and optimum splicing parameters are different from one type of NZDS fiber to the next.

Database of splice mode

Splice Mode	Description
SM	For splicing standard Single-mode fiber (ITU-T G652). The MFD is 9 to 10 um at wavelength of 1310 nm. Automatic arc calibration doesn't work in this splice mode.
NZ	For splicing Non-zero dispersion-shifted fiber (ITU-T G655). The MFD is 9 to 10 um at wavelength of 1550 nm. Automatic arc calibration doesn't work in this splice mode.
DS	For splicing Dispersion-shifted fiber (ITU-T G653). The MFD is 7 to 9 um at wavelength near 1550 nm. Automatic arc calibration doesn't work in this splice mode.
MM	For splicing Multi-mode fiber (ITU-T G651). Core diameter : 50.0 to 62.5 um Automatic arc calibration doesn't work in this splice mode. This mode is programmed to achieve the best splice loss of MM fiber. The appearance of splice point doesn't look fat

Profile type

SMF :	ITU-T G652	MFD : 9~10 um, Wave length : 1310nm
NZDSF :	ITU-T G655	MFD : 8~10 um, Wave length : 1550nm
DSF :	ITU-T G653	MFD : 7~9 um, Wave length : 1550nm
MMF :	ITU-T G651	Core : 50.0um, 62.5 um

Referring or editing splice mode

Splicing parameters in each splice mode can be modified. Arc power and Arc time are considered the two most vital parameters. To edit parameters follow below steps:

1. In [Select Splice Mode] menu, move cursor to a splice mode to be modified. Press **SET** key to display [Edit Splice Mode] menu.
2. Move cursor by pressing **Up/Down** Arrow key to a parameter to be changed.

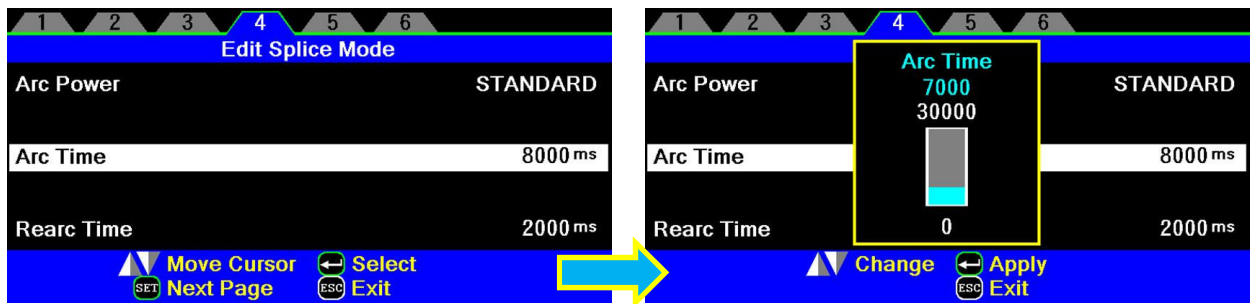

ENT key

Initialization in the edited parameter

It can perform easily by returning mode to initial setting to return a preset value by package after changing a setup of each parameter.

1. The fiber classification of splice edit mode is chosen by the **ENT** key. Choose the same splice mode within splice mode.

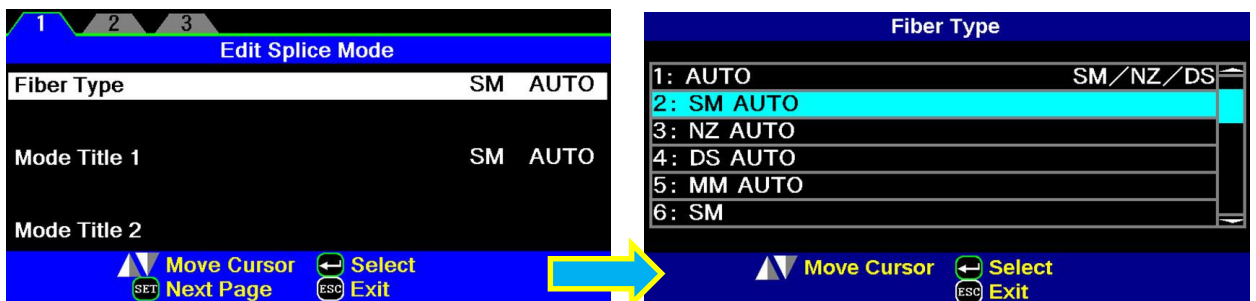

2. Since the following display will come out if the **ENT** key is pressed after selection, Press the **ENT** key after a check.

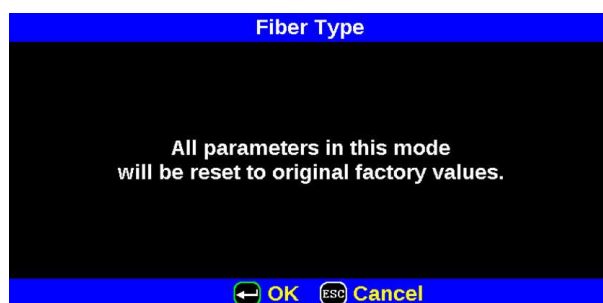

Editing or erasing splice mode

How to create splice mode

There are necessary splice modes stored when the splicer is first delivered, and all the other modes are displayed [BLANK]. Follow the below steps to add a splice mode.

Select a "BLANK" splice mode and press **SET** key. Typical splice modes stored in the splicer database are displayed. Select one splice mode to be copied. Press **ENT** key to execute. Press **ESC** key to verify the fiber type is named in the specific splice mode.

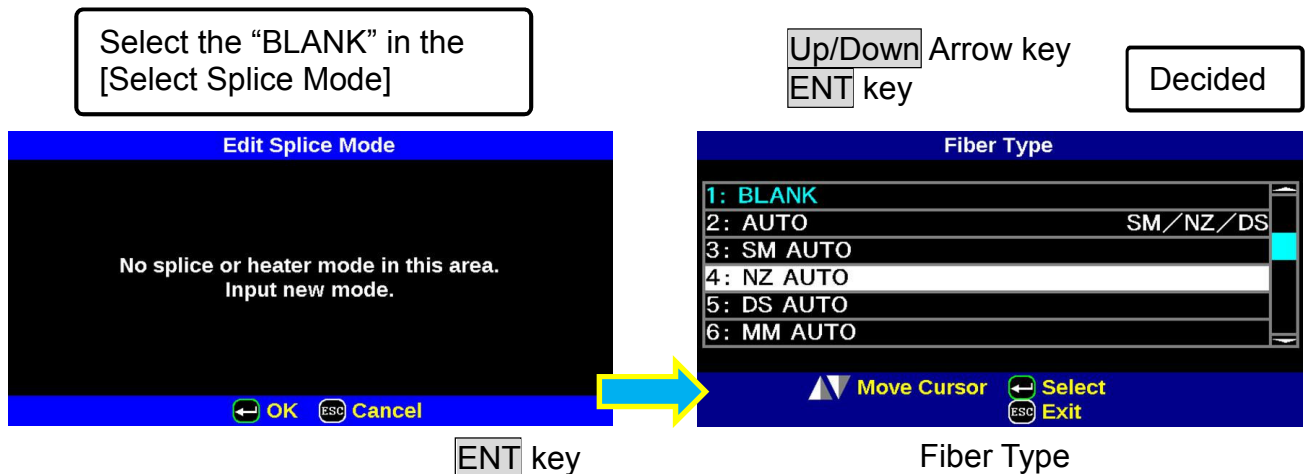

How to erase splice mode

Splice mode can be erased. Follow the below steps to erase splice mode.

1. Select the specific splice mode and press **SET** key to go to [Edit Splice Mode] menu. Select [Fiber Type] by pressing **ENT** key.
2. Select the "BLANK" and press **ENT** key to execute.



- Mode No.1 cannot be erased.
- Mode No.1 is automatically selected after erasing a splice mode.

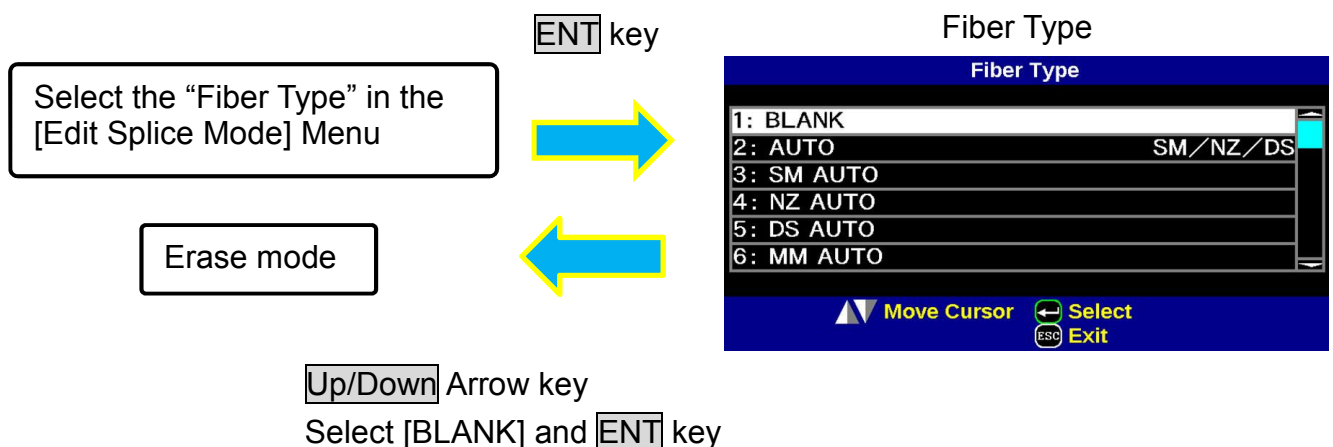

AUTO mode: [SM AUTO]], [MM AUTO]], [NZ AUTO]], [DS AUTO] [AUTO SM/NZ/DS]

Below is a list of Splicing parameters for AUTO modes

Only a limited number of parameters listed below are displayed for AUTO modes to simplify the operation. Additional hidden parameters are all fixed values set at the factory.

Parameter	Description
Fiber Type	List of splice modes stored in database is displayed. A selected splice mode stored in the database area is copied to a selected splice mode in the user-programmable area.
Mode Title1	Title for a splice mode expressed in up to 11 characters.
Mode Title2	Detail explanation for a splice mode expressed in up to 15 characters. Title2 is displayed at the [Splice Mode Select] menu.
Loss Limit	An error message is displayed if the estimated splice loss exceeds selected threshold (loss limit).
Offset Limit	An error message is displayed if the fiber offset exceeds the selected threshold (offset limit).
Cleave Limit	An error message is displayed if the cleave angle of either the left or right fiber ends exceeds the selected threshold (cleave limit).
Cleave Shape Error	Error message is displayed if the cleaved end face of either left or right fiber exceeds the selected threshold (cleave shape).
Arc Power	The Arc Power is fixed at STANDARD for AUTO modes. The Arc Power is changed automatically.
Arc Time	Arc Time is fixed at 6000ms. This is automatically set depending on the cladding illumination during Arc Discharge.
Cleaning Arc	A cleaning arc burns out micro dust on the surface of the fiber with an arc discharge for a short period of time. The duration of the cleaning arc can be changed by this parameter.
Rearc Time	Splice loss may be improved by an additional "rearc" discharge in some cases. The duration of this additional arc can be changed by this parameter.



- Menu change when [Select Splice Mode] is set to [SM], [NZ], [DS] and [MM] mode.

Standard mode: [SM], [NZ], [DS], [MM]

Splicing parameters: standard modes

In other splice modes in the user-selectable database, the user can select from a series of factory-set splicing modes for various splicing combinations. Below are the descriptions of the various parameters used in these modes.

Parameter	Description
Fiber Type	A list of splice modes stored in the splicer database is displayed. Upon inputting the appropriate mode, the selected splice mode stored in database area is copied to a selected splice mode in user-programmable area.
Mode Title1	Title for a splice mode expressed in up to 11 characters.
Mode Title2	Detail explanation for a splice mode expressed in up to 15 characters. Title2 is displayed at the [Splice Mode Select] menu.
Loss Limit	An error message is displayed if the estimated splice loss exceeds selected threshold (loss limit).
Offset Limit	An error message is displayed if the fiber offset exceeds the selected threshold (offset limit).
Cleave Limit	An error message is displayed if the cleave angle of either the left or right fiber ends exceeds the selected threshold (cleave limit).
Cleave Shape Error	Error message is displayed if the cleaved end face of either left or right fiber exceeds the selected threshold (cleave shape).
Cleaning Arc	A cleaning arc burns out micro dust on the surface of the fiber with an arc discharge for a short period of time. The duration of the cleaning arc can be changed by this parameter.
Gap	Sets the end-face gap between the left and right fibers at the time of aligning and pre-fusion discharge.
Gapset Position	Sets the relative position of the splicing location to the center of electrodes. Splice loss may be improved in the case of dissimilar fiber splicing by shifting [Gapset Pos] towards a fiber whose MFD is bigger than the other fiber MFD.
Prefuse Power	Sets the power of the prefuse arc, which is an arc discharge occurring from the beginning until the fibers begin stuffing. If [Prefuse Power] is set too low, axial offset may occur if cleaved angles are relatively poor. If [Prefuse Power] is set too high, fiber end faces are fused excessively and splice loss gets worse.
Prefuse Time	Sets the duration of the prefuse arc, which is arc discharge occurring from the beginning until the fibers begin stuffing. Longer [Prefuse Time] is synonymous with higher [Prefuse Power].
Overlap	Sets the overlap amount of fibers at the fiber stuffing stage. Relatively small [Overlap] is recommended if the [Prefuse Power] is low, while relatively large [Overlap] is recommended if the [Prefuse Power] is high.

A continuation of edit parameter list

Parameter	Description
Arc Power	Sets Arc Power. The arc intensity expressed in units of “bits”.
Arc Time	Sets Arc time. The total arc discharge time including the pre-fuse time.
Rearc Time	Splice loss may be improved by an additional “rearc” discharge in some cases. The duration of this additional arc can be changed by this parameter.
Taper Splice	Splice loss is sometimes improved when the fiber is tapered (pulled) during arc discharge to make the splice thinner. This sets taper function "ON". The following three parameters determine the taper shape.
Taper Wait	Sets the taper wait time from the end of fiber stuffing until the start of pulling fiber.
Taper Speed	Sets the fiber pulling speed.
Taper Length	Sets the fiber pulling length.
Estimating Mode	Selects splice loss estimation to "OFF" or "ON".
Minimum Loss	This amount is added to the estimated splice loss originally calculated. When splicing specialty or dissimilar fibers, a high actual splice loss may occur even with optimized arc conditions. To make the actual splice loss concur with the estimated splice loss, set the minimum value of estimate to the minimum optimized actual splice loss.
MFD	Sets MFD of the fibers. This MFD value is taken into account for estimating splice loss.
Estimating Coef.	This amount influences the splice loss estimation. When there is the difference between actual splice loss and estimated loss, adjust this value.
Proof Test	If [Proof Test] is set to "ON", a proof-test is performed upon opening the wind protector after splicing or by pressing the RESET key.



- Menus change when [Select Splice Mode] is set to [SM AUTO], [NZ AUTO], [DS AUTO] and [MM AUTO] mode.

Memory

This splicer stores up to 2,000 splicing results. Contents of data stored are different depending on splicing mode.

Splice Results Reference or Elimination

Splicing results stored in the memory can be displayed. Comments can be added or edited.



- Memory Data can be downloaded by USB. Refer to instruction manual of "Data Connection".

How to display the splice Result data

1. Select [Memory] in [Splice Settings] and select [Splice Results] and press **ENT** key to display [Splice Results] Menu.

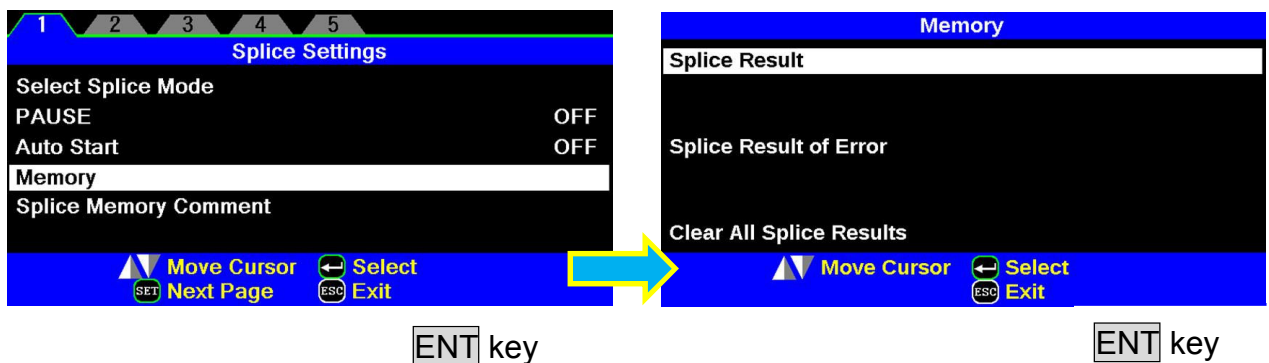

2. Splice memory is displayed.
3. Select memory number by moving cursor to a specific memory number and press **ENT** key. The selected splicing result is displayed.
Press **SET** key to select a [Jump /Remove] option. Select the oldest data or Latest data by pressing **Up/Down** Arrow key. This can be removed by pressing **ENT**.

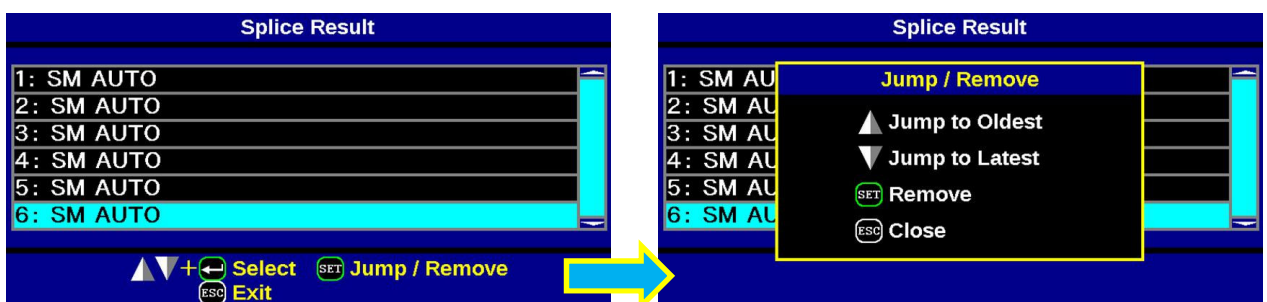

4. The selected splicing result is displayed. For adding or editing comments, press **ENT** key to display [Input Comment] screen.

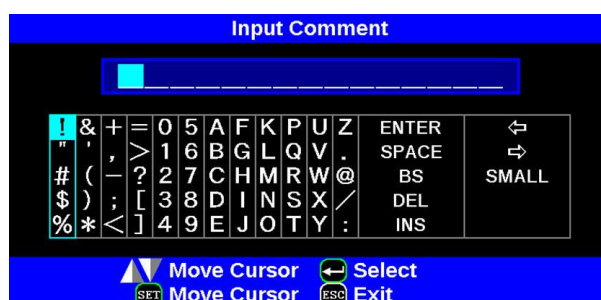

How to Clear the Splice Results data

1. Press **ENT** key in [Splice Result] Menu.
2. Press **SET** key in [Jump / Remove] Menu.
3. Select the first data in the range to be deleted by **ENT** key.
4. Select the last data in the range to be deleted by **Up/Down** arrow key.

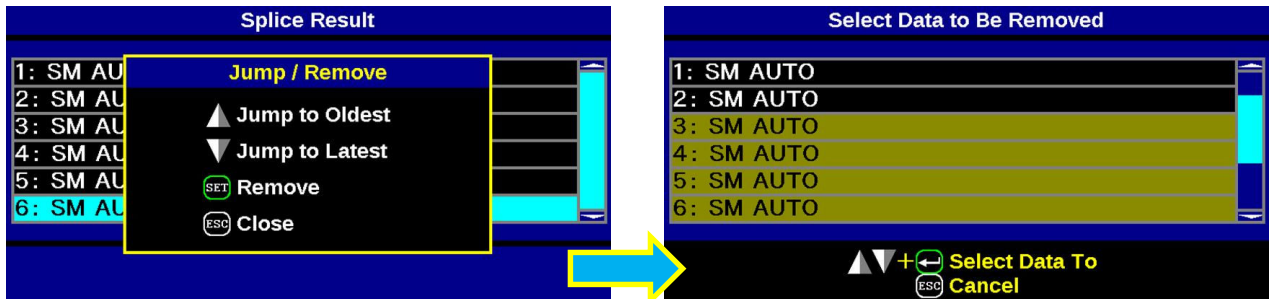

5. Press **ENT** key to select the highlighted range. Press **ENT** key to delete the memory.

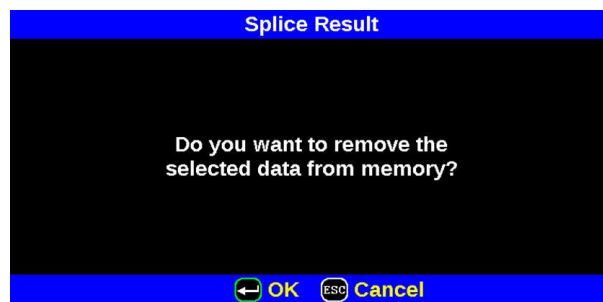

How to display the splice Result of error

Only the memory which the error generated like the splice result memory display method can be displayed.

1. Select the splice result of error by pressing **ENT** key.

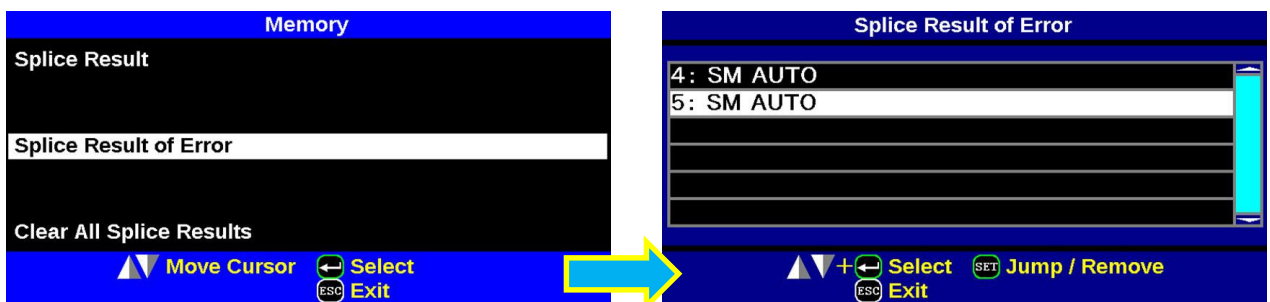

2. Only a memory with an error is displayed.

Select Heater Mode

Each tube-heating mode is optimized for a type of Fujikura protection sleeve. These modes can be found in database area for reference. Copy the appropriate one and paste it to the user-programmable area. The operator can edit the user-programmable modes.

Data Base

Parameter	Description
60mmS FP-03	For standard 60mm protection sleeve, Such as Fujikura FP-03 or FP-03M protection sleeves.
40mmS FP-03(L=40)	For standard 60mm protection sleeve, Such as Fujikura FP-03(40mm) or FP-03M protection sleeves. Note : Cleave length 8mm.
40mmR FP-04T	For standard 40mm protection sleeves, Such as Fujikura FP-03 (L=40).
15mmS FPS01-400-15	For 400 or less um of diameters of coating and splice of the interference length of 5 mm or less
20mmS FPS01-900-20	For 900 or less um of diameters of coating and splice of the interference length of 6 mm or less
60mmS FPS01-DC-60	For Splice of a drops cable.
28mmS FC-SC-**-30/20	For Fuse connect splice.
45mmS FC-SC-**-09	

The dimensions of the Protection Sleeve after shrink

Form	Tension member	Sleeve length	Prepare fiber length	Diameter of an adaptation optical fiber	Diameter of a result
FP-03	SUS	60mm	16mm or less	250~900um	3.1mm
FP-03(40mm)	SUS	40mm	10mm or less	250~900um	3.1mm
FP-04T	Glass Ceramic	40mm	10mm or less	250~900um	4.0mm
FPS01-400-15	SUS	15mm	5mm or less	~400um	1.5mm
FPS01-900-20	SUS	20mm	6mm or less	~900um	2.3mm

* The dimensions of the protection sleeve after shrink vary depending on the diameter of the fiber.

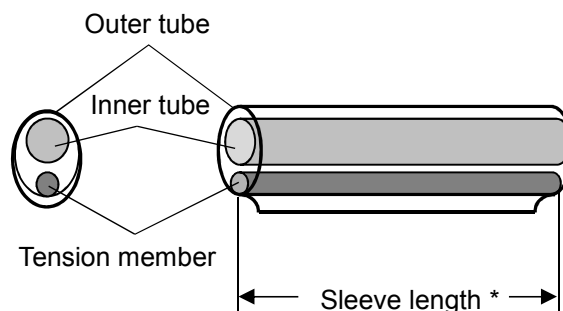

Selecting Heater Mode

Select the heater mode most suitable for the protection sleeve to be used.

1. Press **ENT** key in [READY], [PAUSE], [FINISH] state and press **SET** key to display [Heater Menu].

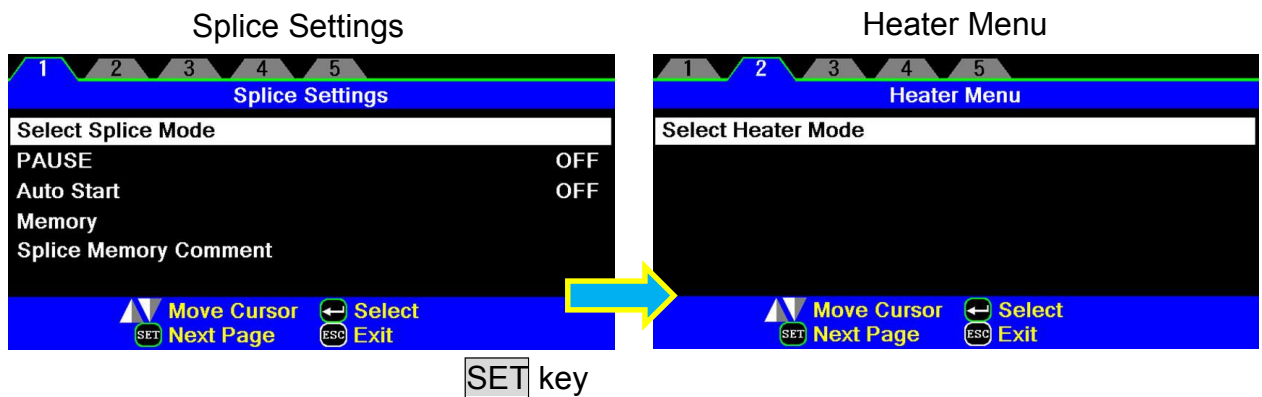

2. Select [Select Heater Mode] in [Heater Menu]. [Select Heater Mode] menu is displayed.
3. Move cursor by pressing **Up/Down** Arrow key and press **ENT** key to select a heater mode.

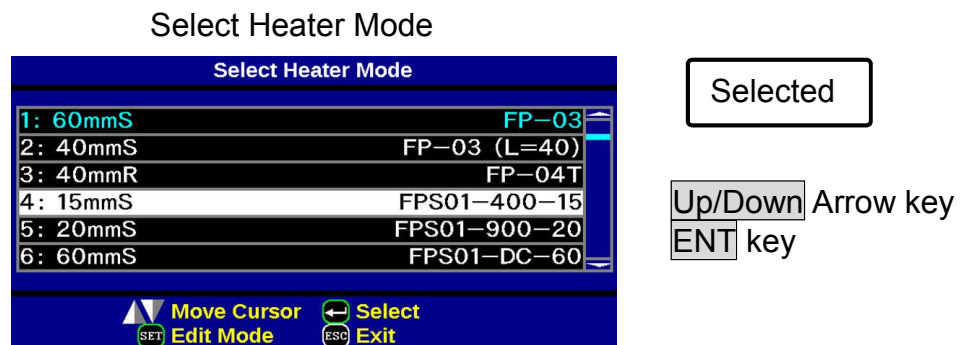

4. Check that the proper heater mode has been chosen on the READY screen.

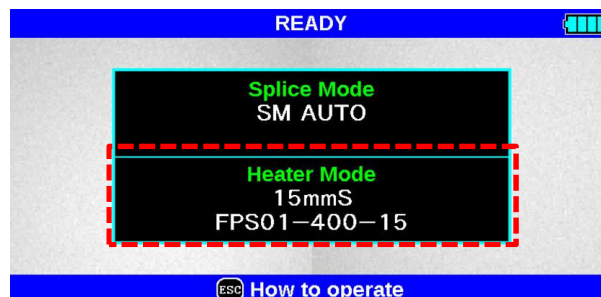

- When using a non-Fujikura protection sleeve, please set up parameter in separate heater modes.
- When using a non-Fujikura protection sleeve, the intensity of a protection point cannot be warranty.

Referring to or Editing Heater Mode

Tube-heating conditions stored in heater mode can be edited or changed.

1. Move cursor and select a mode to be edited in [Select Heater Mode] menu. Press **SET** key to display [Edit Heater Mode] menu.
2. Press **Up/Down** Arrow keys to move cursor to a parameter to be changed then press **ENT** key to enter.
3. Change value by pressing **Up/Down** key, then press **ENT** key to enter.

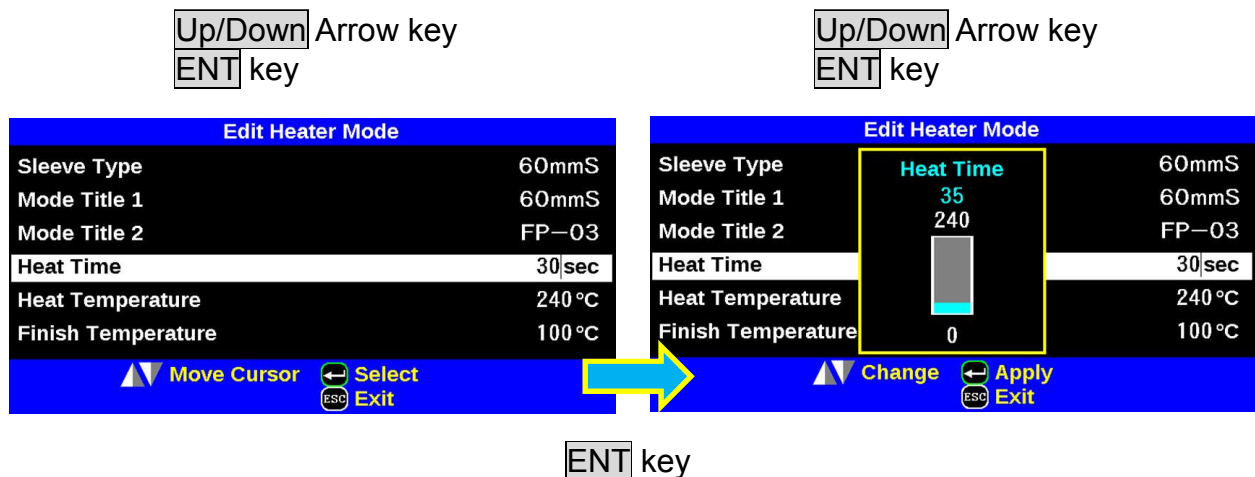

Heater mode parameters

Parameter	Description
Sleeve type	Sets sleeve type. List of all heating modes are displayed. Select a mode in the list and this is copied to a user-programmable mode.
Mode Title1	Title of a heater mode that is displayed in the lower right part of the monitor during the splicing/heating process. Max number of characters used is 7.
Mode Title2	Description of a heater mode in the [Sleeve Type] screen. Max number of characters used is 15.
Heat Time	Sets heating time from the beginning to the end (cool-down completion). Heating time is automatically adjusted with atmospheric conditions, such as ambient temperature. Heating time may be longer or shorter than [Heat time] set.
Heat Temperature	Sets heating temperature.
Finish Temperature	Sets the finish temperature. The buzzer beeps after completion of the heating. Caution Do not touch the shrunken sleeve after removing the fiber from the tube heater. It may be hot. Hot sleeves easily deform and can cause some residual stress at the splice point. Use J-plate to cool down the sleeve.

About heating of a connector splice part

The heater of this splicer corresponds to connector.

It can be used for connectors from other companies by changing the sheath clamp portion, and the heating operation can be performed easily.

Exchange of a heater clamp

1. Remove the rear screw of the heater.

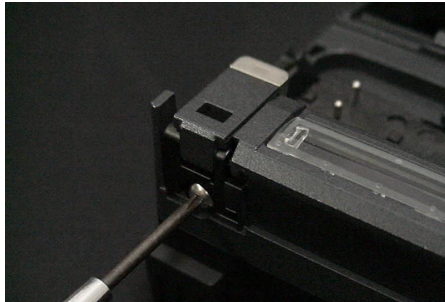

2. Clamp unit is made to slide and exchanged for other size.



When using Fujikura Fuse Connect, removing the clamp is unnecessary. Heating contraction work can be done in the usual state.

*The sleeve position may need to be shifted prior to heating.

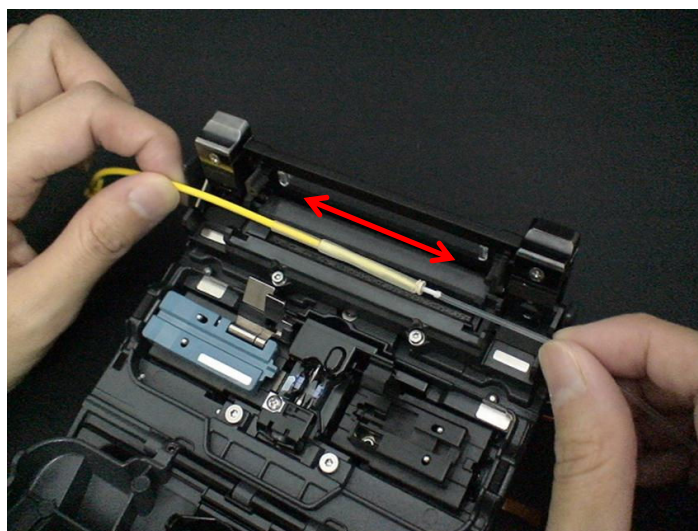

Splice Settings

Common parameters for all the modes for splicing can be set.

1. Press **[ENT]** key in [READY], [PAUSE], and [FINISH] state and press **[SET]** key to display [Setting Menu].
2. Select [Splice Settings] in [Setting Menu] to display [Splice Settings] menu.
3. Password will be required. Enter the password.
4. Select a parameter to be changed. Press **[ENT]** key to change values.
5. Change value by pressing **[Up/Down]** key, then press **[ENT]** key to enter.

Select the [Splice Settings] in the [Setting Menu]

[ENT] key

Splice Settings

Splice Settings	
Ignore Splicing Error	
Loss	Enable
Bubble	Enable
Fat	Enable
Thin	Enable
Move Cursor Next Page	Select Exit

Setting Menu parameter list

Parameter	Description
Ignore Splicing Error	
Loss	Setting to “Disable” prevents the splicer from finishing its operation. Splice loss estimation is not displayed; operator must press reset to continue.
Bubble	
Fat	
Thin	
Cleave	Setting to “Disable” prevents the splicer from continuing splice sequence, requires operator to re-prep fibers.
Offset	Setting to “Disable” prevents the splicer from continuing splice sequence, requires operator to re-prep fibers.
Others	
Auto Fiber Forward	If “Auto Fiber Forward” is set to “ON”, fibers are automatically moved closer to gap set as soon as wind protector is closed.
Max Num. of Rearcs	The re-arc process sometimes improves the splice loss, but sometimes worsens it. Re-arc decreases the splice strength. With this function, it is possible to limit the number of re-arcs or to disable re-arc discharge.

Maintenance Settings

The parameter about warning and a maintenance item can be changed.

1. Press **ENT** key in [READY], [PAUSE], and [FINISH] state and press **SET** key to display [Setting Menu].
2. Select [Maintenance Settings] in [Setting Menu] to display [Maintenance Settings] menu.
3. Password will be required. Enter the password.
4. Select a parameter to be changed. Press **ENT** key to change values.
5. Change value by pressing **Up/Down** key, then press **ENT** key to enter.

Select the [Maintenance Settings] in the [Setting Menu]

ENT key

Maintenance Settings

Maintenance Settings	
Electrode	
Electrode Caution	2000
Electrode Warning	2500
Arc Calibration	
CleaveLimit	3.0°
Max Number of Tests	3
▲▼ Move Cursor ↵ Select ESC Exit	

Available to set the parameters about warning and maintenance item.

Parameter	Description
Electrode	
Electrode Caution	A setup of the number of times of Caution can be performed. If a preset value is exceeded, it will be indicated by alarm on display.
Electrode Warning	A setup of the number of times of Warning can be performed. If a preset value is exceeded, it will be indicated by alarm on display.
Arc Calibration	
Cleave Limit	Sets the threshold of cleave angle error in the [Arc Calibration].
Max Number of Tests	Sets the number of tests to finish the [Arc Calibration] with "Test Finished" message.

Machine Settings

1. Press **ENT** key at [READY], [PAUSE] or [FINISH] screen and press **SET** key to display [Setting Menu].
2. Select [Machine Settings] in [Setting Menu]
3. Password will be required. Enter the password.
4. Select a parameter to be changed.

Select the [Machine Settings] in the [Setting Menu]

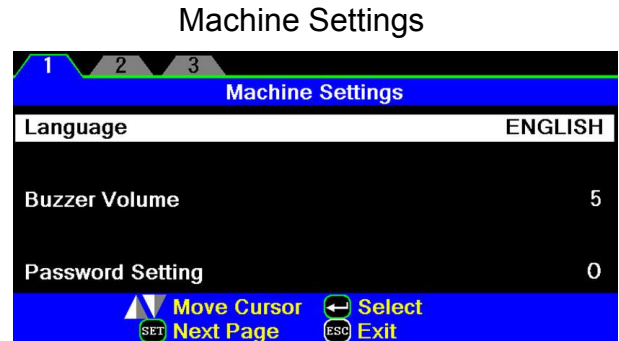
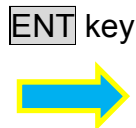

Language

Set a language to displayed on the screen. Select a language to be displayed. The language that can be displayed changes by a software version and region code.

Buzzer Volume

Set the sound volume of the buzzer.

Password Setting

Changes the password to access the [Splice Settings], [Maintenance Settings], [Machine Settings], [Menu Lock Settings] menus. The password is also used to unlock the power-on password lock.

Maximum Characters: 9

At the time of shipment from factory, the password is set at "0".

In the event you have forgotten your password, contact the authorized distributor.



Power Save function in Machine Settings

This function is important for energy conservation. If the power saving function is not set during battery pack use, the number of splice cycles will be decreased. The splicer automatically identifies the type of power supply unit. In addition, it can program an independent power saving setting. Utilizing these features enables automatic turning on or off of the power saving function after detecting the power supply units.

Setting Power Save

1. Select [Machine Settings] in the [Setting Menu] to display [Turn-Off Time] setting menu.
2. Change value of [Monitor] Turn-Off Time and [Splicer] Turn-Off Time.

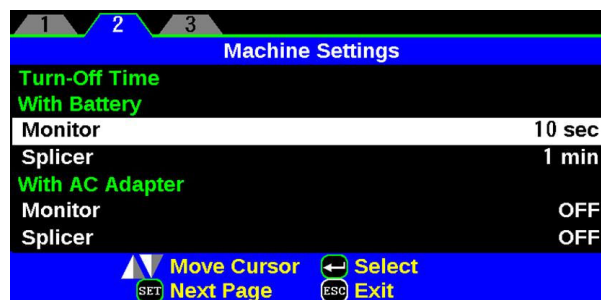

Setting Power Save function

Parameter	Descriptions
Turn-Off Time 《With Battery》 《With AC Adapter》	
Monitor	Setting this function turns off the power supply to the LCD monitor if the splicer performs no operation after a certain period of time. Always set this function to a specific shutdown time when using the battery pack. When the power supply to the LCD monitor turns off, the LED near the ON/OFF key blinks. Pressing any key turns on the LCD monitor.
Splicer	Automatically turns off the power supply to the splicer if it performs no operation for a certain period of time. The function serves to prevent the battery capacity from running low if the splicer is left on for an extended period of time.

Power On Option in Machine Settings

Set Opening title and Password Lock function

Parameter	Descriptions
Power On Option	
Opening Title1	Sets the message to be displayed when the power is turned on. Max. number of characters : 15 (Opening Title1) 15 (Opening Title2)
Opening Title2	
Power On Password	A password is required at splicer boot up in order to operate it.

Menu Lock Settings

1. Select [Menu Lock Settings] in the [Setting Menu]. Password input screen is displayed.
2. Input Password. See Section [Machine Settings] on how to input password.
3. Change a parameter value.

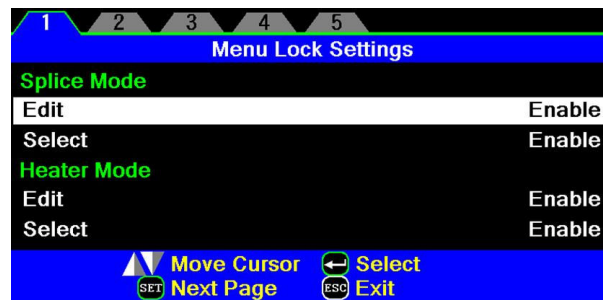

Used for Administrator to limit operator from selecting or changing certain functions.

Parameter	Descriptions
Splice Mode	
Edit	Setting to “Disable” prevents unauthorized editing and selecting of splice modes.
Select	
Heater Mode	
Edit	Setting to “Disable” prevents unauthorized editing and selecting of heater modes.
Select	
Splice Result	
Clear	Setting to “Disable” prevents unauthorized erasing of splice result data on the memory.
Splice Settings	
Edit	[Splice Settings] Menu cannot be edited if this is set to “Disable”.
Maintenance Settings	
Edit	[Maintenance Settings] Menu cannot be edited if this is set to “Disable”.
Machine Settings	
Buzzer Volume	Setting to “Disable” prevents unauthorized adjusting.
Turn-Off Time	Setting to “Disable” prevents unauthorized changing of the power saving function.
Power On Option	Setting to “Disable” prevents unauthorized power on option.
Maintenance Menu	
Replace Electrodes	Setting to “Disable” prevents various functions related to maintenance.
Stabilize Electrodes	
Clear Arc Count	
Motor Drive	
Diagnostic Test	
Dust Check	
Arc Calibration	
Motor Calibration	

Maintenance Menu information

The splicer has the ability to perform routine maintenance. This section describes how to use the maintenance menu.

1. Press **ENT** key in [READY], [PAUSE] or [FINISH] state. Press **SET** key to display [Maintenance Menu], [Maintenance Menu2].
2. Select a function to perform.

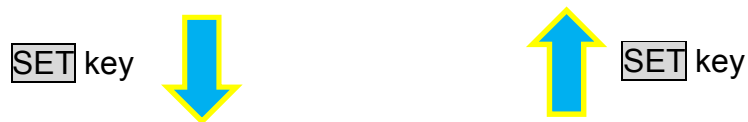
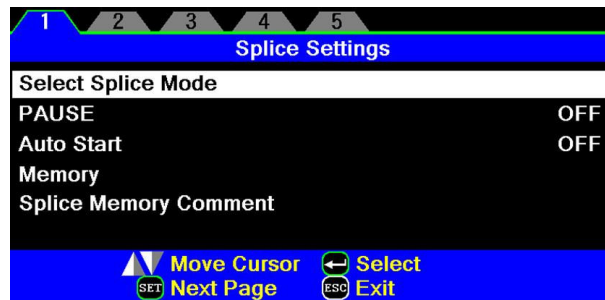

Maintenance Menu

Maintenance Menu2

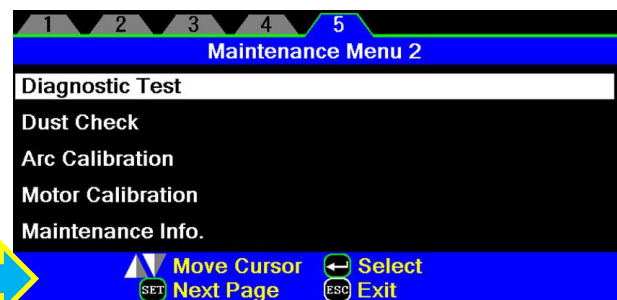
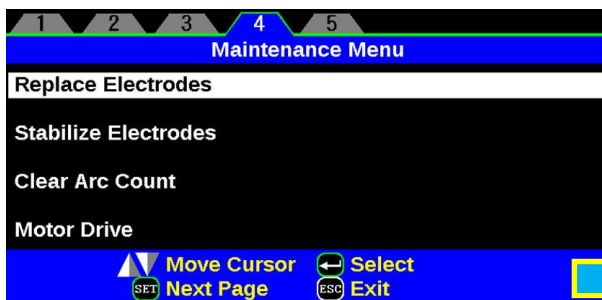

SET key

Replace Electrodes

When the number of arc discharges reaches a count of setting value a message prompting to replace the electrodes is displayed immediately after turning on the power. Using the worn electrodes will result in greater splice loss and reduced splice strength.

Replacement Procedure

1. Execute [Replace Electrodes] in [Maintenance Menu].
2. Instruction messages will appear on the screen to turn off the power. Press and hold **ENT** key till the LED color changes from green to red.
3. Remove the old electrodes.



To remove and replace the electrodes:

- i. Remove the electrode cover and loosen screw located on electrode holder.
- ii. Take electrode out of electrode holder. (Electrode is fit in electrode holder)

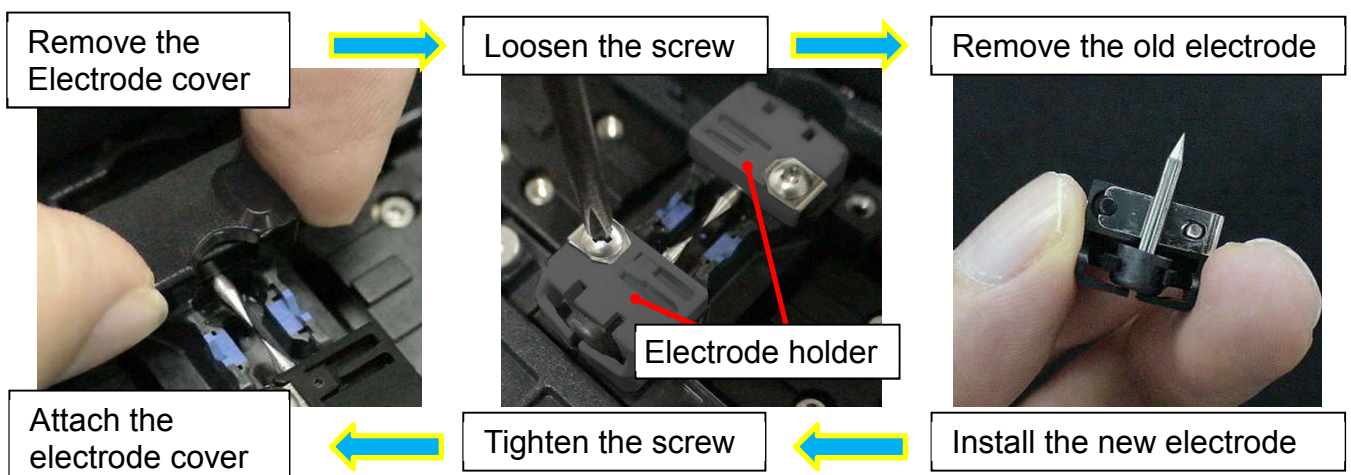

4. Install the new electrodes with care; do not hit the electrode tips.
 - i. Fit the electrode in the electrode holder.
 - ii. Place the electrode holder on the splicer and tighten screw.



- Apply tightening torque of 200CNm when tightening screw to fix electrode.
- Make sure the electrodes are attached firmly after tightening screws.

5. Turn on the power, prepare and load a non-cleave fibers into the splicer and press **ENT** key. After executing the arc calibration, the splicer will repeat arc discharge 30 times in succession to stabilize the electrodes.
6. Upon completion of repeated arc discharge, the splicer executes an arc calibration again. The operator should repeat arc calibration until the “Test Finish” message appears. For details of the arc calibration process, see section [Arc Calibration].

Stabilize Electrodes

In the event of sudden change in environmental conditions, etc., the arc power sometimes becomes unstable, resulting in higher splice loss. Especially when the splicer is moved from lower altitudes to higher altitudes, it takes time for the arc power to stabilize. In this case, stabilizing electrodes will expedite the process of making the arc power stable. If many tests are needed until the “Test OK” message appears in [Arc Calibration], use this function as well.

Operation Procedure

1. Select the [Stabilize Electrodes].

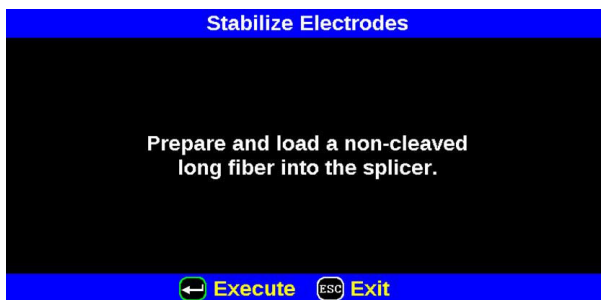

2. Set prepared and load a non-cleaved long fibers in the splicer.
3. Press **ENT** key and the splicer begins to stabilize the electrodes in the following ways:
 - Repeats short arc discharge four times to measure the arc position.
 - Perform 30-cycle continuous discharge to stabilize the electrodes.
4. After completing stabilization, always perform an additional [Arc Calibration].

Clear Arc Count

This function enables the stored number of arc discharges to be reset.

1. Select the [Clear Arc Count].
2. As the confirmation screen “Is it OK to clear?” appears, press **ENT** key to clear.



- This function is included in the [Replace Electrodes] function.
- The number of arc discharges in the “Total Arc Count” field displayed on the [Maintenance Info.] screen cannot be reset.

Motor Drive

The two motors incorporated in the splicer can be manually operated individually. In the course of splicing, the motors can also be operated by calling this menu in the [PAUSE], or [FINISH] state.

1. Select the [Motor Drive].
2. Pressing **SET** key changes motor selection. The name of the selected motor is displayed in the upper section of the screen.
3. Press **Up/Down** Arrow key to drive the motor in the desired direction.

Motor	Up Arrow key	Down Arrow key
ZL/ZR	Forward	Backward



- When the motor reaches the limit of the operating range, the buzzer sounds and the motor stops. Press the opposite arrow key to reverse and move the motor again.
- Display messages can be erased by pressing **ENT** key. The message can be displayed by pressing **ENT** key again.
- If the motor is moved too much with respect to the spliced fiber, the fiber may break.

Diagnostic Test

The 12S has a built in diagnostic test feature that allows the operator to perform a simple one step evaluation of splicer performance covering several different critical variables. Perform this function in the event of splicer operation trouble.

Operation Procedure

1. Select the [Diagnostic Test] in the [Maintenance Menu 2] and execute [Diagnostic Test]. The following checks will be made.

Check Item	Description
LED Check	Measures and adjusts the brightness of the illumination LED.
Dust Check	Checks the optical path for dust or dirt and judges whether they disturb fiber observation. If contamination exists, this function indicates the location.
Motor Calibration	Check the Motor Limit Sensor.
Arc Calibration	Automatically calibrates the arc power factor and fiber splicing position.
I/O Port Check	Checks for normal operation of the input and output terminals of the internal circuit.
Memory Check	Checks the memory of the internal circuit.



- Before the start of the test, remove the fibers from the splicer.
- When the Motor check is completed, prepare and load the fibers into the splicer and press **ENT** key.

2. Upon completion of all checks and adjustments, a list of results is displayed. If the dust check result is not good, clean the objective lenses cover. In the case that cleaning cannot eliminate contamination, there is a possibility that the contamination may have entered the inside of the optical path. Please contact the authorized distributor for additional instructions.

The dust check and Motor Calibration functions exist as independent instructions in [Maintenance Menu 2]. It is possible to execute them independently.

Dust Check

The splicer observes fibers through image processing. Dust or contaminants on the cameras and lenses cover disturb normal observation of fibers and may result in improper splicing. This function checks the optical path for the presence or absence of contaminants and judges whether they cause trouble for fiber splicing.

Operation Procedure

1. Select the [Dust Check] in the [Maintenance Menu 2].



2. If fibers are set in the splicer, remove them and press **ENT** key again. The splicer begins the dust check.
3. After observation, the location of contamination judged as a potential problem blinks. If contamination is discovered, clean the objective lenses cover and redo [Dust Check] for cleaning instructions.
4. Press to finish dust check.



- In case you have cleaned the objective lenses cover, and dirt or dust still remain, contact the authorized distributor.

Arc Calibration

Atmospheric conditions such as temperature, humidity, and pressure are constantly changing, which creates variability in the arc temperature. This splicer is equipped with temperature sensor that is used in a constant feedback monitoring control system to regulate the arc power at a constant level. Changes in arc power due to electrode wear and glass adhesion cannot be corrected automatically. Also, the center position of arc discharge sometimes shifts to the left or right. In this case, the fiber splicing position has to be shifted in relation to the arc discharge center. It is necessary to perform an arc power calibration to eliminate both of these issues.



- Arc calibration is performed automatically using [AUTO] mode only. So arc calibration does not have to be performed when splicing in this mode.
- Execute [Arc calibration] before using non-auto mode.
- Performing the [Arc Calibration] function change the arc power “factor” value. The factor value is used in the algorithm program for all splicing. The arc power value will not change in the splice modes.

Operation procedure

1. Select [Arc Calibration] in [Maintenance Menu 2] to display Arc Calibration screen.
2. Press **ENT** key.
3. Set prepared fibers onto the splicer.

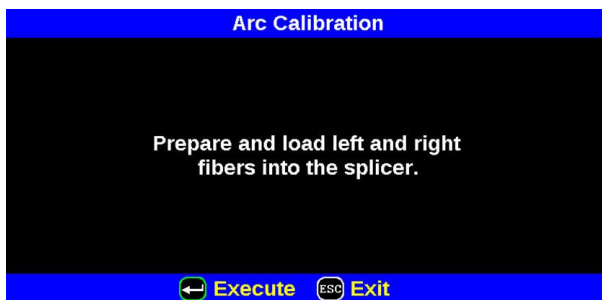

- Use standard SMF ITU-T G652 fiber for Arc Calibration.
- Use well prepared fibers for arc calibration. Dust on the fiber surface affects arc calibration.
- Cleave angle threshold does not link to the parameter "Cleave Limit" in splicing modes. Cleave angle threshold is independently set for arc calibration. See section [Maintenance Settings] to change cleave angle threshold.

4. The ARC Calibration after pressing **ENT** key.

“Good” message

Arc power and splicing position calibration are successfully completed. Press **ESC** key to exit.

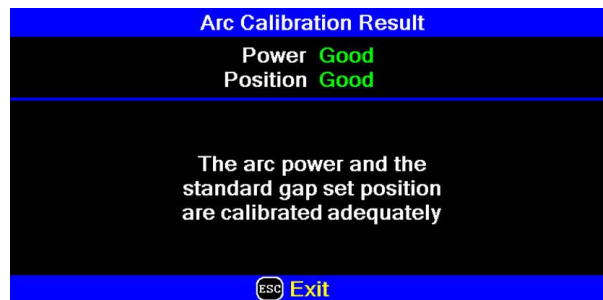

Result: Good

“Not Adequate” message

Arc power and splicing position calibration are completed but further calibration is strongly recommended, as the change from the previous arc calibration is too large. Press **ENT** key to perform arc calibration, or **ESC** key to exit even though arc calibration is not completed.

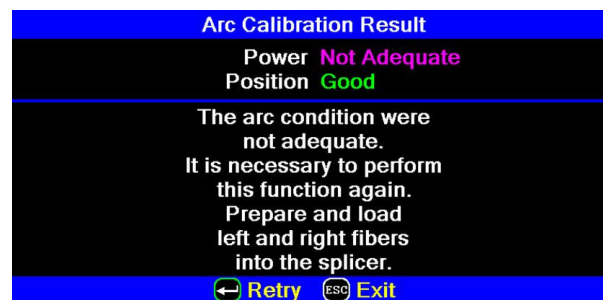

Result: Not Adequate



- In some cases, multiple iterations of arc calibration are needed until the calibration process is successfully completed and the "Test Finish" message is displayed. Arc calibration can be considered almost completed if multiple iterations are completed without receiving the message.
- Number threshold can be set so that "Test Finish" message is displayed after specific number of arc calibrations is performed. See section [Maintenance Settings] for detail.

Motor Calibration

Motors were adjusted at the factory before shipping. However, settings could change due to various reasons. This function automatically calibrates the speed of all two motors.

Operation Procedure

1. Select the [Motor Calibration] in the [Maintenance Menu 2].
2. Load prepared fibers in the splicer and press **ENT** key.
3. Speeds for all motors are automatically calibrated. Upon completion, [Maintenance Menu 2] is displayed.



➤ Perform this function when "Fat" or "Thin" error has occurred.

Maintenance Info

The maintenance information on this equipment can be checked.

Maintenance Info.	
Serial Num.	*****
Version	** **
Arc Count	206
Total Count	1256
Last Authorized Service	2012. 11. 09
Next Authorized Service	2013. 11. 09
ESC Exit	

Select the [Maintenance Info]. The following information is displayed.

Parameter	Description
Serial Num.	Displays the serial number of the splicer.
Version	Displays the version number of the software.
Arc Count	Displays the number of arc discharges after electrode replacement. Performing the function [Replace Electrodes] or [Clear Arc Count] resets this parameter to zero.
Total Count	Displays the total number of arc discharges.
Last Authorized Service	Displays the date of last authorized service.
Next Authorized Service	Displays the scheduled date of next authorized service.

Press **ENT** when an error is shown on the monitor. The [HELP] screen displays the following:

- If error does not have an error code, such as “Cleave Shape NG”, the keystrokes are displayed with information explaining what each keystroke does if pressed.
- If error has an error code, additional information according to the Error Code and Message is displayed.

Follow the solution precisely as shown in the list below. If it is not possible to eliminate the problem, the splicer may require service by a qualified service center. Consult the authorized distributor with the following information:

- Model name of the splicer
- Serial number of the splicer
- Error message
- Error code (if shown)
- Situation when the error occurs

Error Message	Reason	Solution
L-Too Long Fiber	<ul style="list-style-type: none"> • The cleave length (bare fiber part) is too long. • Dust or dirt is on the objective lens or the wind protector mirror. 	<ul style="list-style-type: none"> • Confirm the setting position of the stripped fiber end on the fiber cleaver. Check the cleave length. • Execute the [Dust Check]. Clean the lens or the mirror when dust or dirt exists.
R-Too Long Fiber		
LR-Too Long Fiber		
X-Dark Back Ground	<ul style="list-style-type: none"> • Dust or dirt is on the objective lens or the wind protector mirror. 	<ul style="list-style-type: none"> • Execute the [Dust Check]. Clean the lens or the mirror if dust or dirt exists.
Y-Dark Back Ground		
X-Dark Back Ground	<ul style="list-style-type: none"> • The LED or Camera might be damaged. 	<ul style="list-style-type: none"> • Consult the authorized distributor.
Y-Dark Back Ground		
L-Too Dusty Fiber	<ul style="list-style-type: none"> • Dust or dirt is on the fiber surface. • Dust or dirt is on the objective lens. 	<ul style="list-style-type: none"> • Completely prepare the fiber again (strip, clean and cleave). • Execute the [Dust Check]. Clean the lens if dust or dirt exists.
R-Too Dusty Fiber		

Error Message List

Error Message	Reason	Solution
ZL Motor Overrun (Forward)	<ul style="list-style-type: none"> • The fiber is not set correctly at the bottom of the V-groove. The fiber is not located in the Camera's field of view. • The cleave length (bare fiber part) is too short. 	<ul style="list-style-type: none"> • Press RESET key, and set the fiber again to seat it correctly at the bottom of the V-groove. • Confirm the setting position of the stripped fiber end on the fiber cleaver. Check the cleave length.
ZR Motor Overrun (Forward)		
ZL Motor Overrun (Backward)	<ul style="list-style-type: none"> • The taper speed or taper time is set too high. 	<ul style="list-style-type: none"> • Adjust the taper parameters in the splice mode.
ZR Motor Overrun (Backward)	<ul style="list-style-type: none"> • Only occurs in manual motor operation. 	
Close Cover	<ul style="list-style-type: none"> • Unable to start splicing when the wind protector opens. 	<ul style="list-style-type: none"> • The splicer automatically starts splicing after closing the wind protector.
Cover Open	<ul style="list-style-type: none"> • The wind protector is opened during splicing operation. 	<ul style="list-style-type: none"> • Press RESET key after closing the wind protector.
ZL /ZR Motor Trouble	<ul style="list-style-type: none"> • Motor might be damaged. 	<ul style="list-style-type: none"> • Consult the authorized distributor.
Strong Arc Power	<ul style="list-style-type: none"> • Unable to calibrate due to strong arc. 	<ul style="list-style-type: none"> • Replace the electrodes by using the [Replace Electrodes] function in. If this does not eliminate the problem, consult the authorized distributor.
Weak Arc Power	<ul style="list-style-type: none"> • Unable to calibrate due to weak arc. 	
Too Left /Right Arc	<ul style="list-style-type: none"> • Unable to calibrate due to poor arc field position (too far left or Right). 	
Fiber Separation	<ul style="list-style-type: none"> • The fiber stuff amount is insufficient. 	<ul style="list-style-type: none"> • Execute the [Motor Calibration] function. If using other splice modes, check the [Overlap] setting in the splice mode.
	<ul style="list-style-type: none"> • The pre-fuse power or pre-fuse time is set too high. 	<ul style="list-style-type: none"> • Check the [Prefuse Power] and [Prefuse Time] settings in the splice mode.
L/R-Bad Fiber Position	<ul style="list-style-type: none"> • The fiber is not set correctly at the bottom of the V-groove. 	<ul style="list-style-type: none"> • Press RESET key, and re-position the fiber again to seat it correctly at the bottom of the V-groove.
No Arc Discharge	<ul style="list-style-type: none"> • Arc Discharge did not occur. 	<ul style="list-style-type: none"> • Assure the electrodes are in proper position. • Replace the electrodes. • Consult the authorized distributor.

Error Message List

Error Message	Reason	Solution
Large Cleave Angle	• Bad fiber end-face.	• Check the condition of the fiber cleaver. If the blade is worn, rotate the blade to a new position.
	• [Cleave Limit] is set too low.	• Increase the [Cleave Limit] to an adequate limit.
Large Fiber Angle	• Dust or dirt is on the V-groove or the clamp chip.	• Clean the V-groove and clamp chip, and set the fibers again. If the error occurs again, strip, clean and cleave the fibers.
	• Bad fiber end-face.	• Check the condition of fiber cleaver. If the blade is worn, rotate the blade to a new position.
Cleave Shape NG	• Bad fiber end-face.	• Check the condition of fiber cleaver. If the blade is worn, rotate the blade to a new position.
Arc Discharge Delayed	• Arc Discharge is delayed	• Assure the electrodes are in proper position. • Execute the [Stabilize Electrode] function. • Replace the electrodes.
Thin Fiber	• Inadequate arc power	• Calibrate the arc power with the [Arc Calibration] function.
	• Prefuse power or time is set too high	• If using the Other mode, adjust or initialize [Prefuse Power] or [Prefuse Time] settings. For normal splice mode, the prefuse is fixed and cannot be adjusted.
	• Insufficient [Overlap] setting	• If using the Other mode, adjust or initialize [Overlap] setting. For normal splice mode, the overlap is fixed and cannot be adjusted.
Fat Fiber	• Too much [Overlap] setting	• Execute [Motor Calibration] function in the maintenance menu to calibrate the stuff amount.
Too Tapering Fiber	• Too much fiber taper.	• If using the taper splice function, the error message may appear meaning the fiber is tapered too much.
Bubble	• Bad fiber end-face.	• Check the condition of fiber cleaver. When the blade is worn, rotate the blade.
	• Prefuse power or time is set too low	• If using the Other mode, adjust or initialize [Prefuse Power] or [Prefuse Time] settings. For normal splice mode, the prefuse is fixed and cannot be adjusted.
Large Dust Burn	• Bad fiber end-face.	• Check the condition of the fiber cleaver. If the blade is worn, rotate the blade to a new position.
	• [Cleaning Arc] time is too short or "OFF."	• Dust still present after cleaning fiber or cleaning arc. Clean fiber thoroughly or Increase [Cleaning Arc Time]

Error Message	Reason	Solution
High Estimated Loss	<ul style="list-style-type: none"> • Insufficient fiber cleaning. 	<ul style="list-style-type: none"> • Dust or dirt on the fiber surface results in bad splice loss and low tensile strength. • Clean the fiber surface sufficiently. • Do not clean the fiber after cleaving to prevent dust on the fiber end-face. • Avoid any contact with the fiber end-face.
	<ul style="list-style-type: none"> • Bad fiber end-face. 	<ul style="list-style-type: none"> • Check the condition of fiber cleaver. If the blade is worn, rotate the blade to a new position. • Confirm the [Cleave Limit] setting. 2.0° or less is recommended.
	<ul style="list-style-type: none"> • Dust or dirt is on the V-groove or the clamp chip. 	<ul style="list-style-type: none"> • Dust or dirt on the V-groove or clamp chip causes poor fiber movement during fiber stuffing. Clean them periodically.
	<ul style="list-style-type: none"> • Dust or dirt is on the lens 	<ul style="list-style-type: none"> • Execute the [Dust Check]. If dust or dirt exists, clean the lenses.
	<ul style="list-style-type: none"> • Bad electrode condition. 	<ul style="list-style-type: none"> • Replace the electrodes if they appear worn (rounded tip shape), dirty or bent.
	<ul style="list-style-type: none"> • Inadequate arc power. 	<ul style="list-style-type: none"> • Calibrate the arc power with the [Arc Calibration] function.
	<ul style="list-style-type: none"> • Using unsuitable splice mode 	<ul style="list-style-type: none"> • Select a suitable splice mode for the fibers to be spliced.
	<ul style="list-style-type: none"> • [Loss Limit] is set too low. 	<ul style="list-style-type: none"> • Increase [Loss Limit] to an adequate limit.
	<ul style="list-style-type: none"> • Inadequate arc parameters in other splice modes 	<ul style="list-style-type: none"> • Confirm the arc parameters are adequate to splice the fibers.
<ul style="list-style-type: none"> • Inadequate estimating parameters in Other mode 	<ul style="list-style-type: none"> • Confirm the estimating parameters are adequate to estimate the loss. The MFD mismatch function does not work for certain types of specialty fibers. In these cases, set the [MFD Mismatch] to "OFF". 	

Error Message List

Error Message	Reason	Solution
There is dust after executing Dust Check function	• Dirt or dust exists in optical path.	• Clean the objective lenses by referring see section [Cleaning of Objective Lens]. • When the above processes cannot remove the dirt or dust, consult the authorized distributor.
X Camera Y Camera Trouble	• The Camera may be damaged.	• Consult the authorized distributor.
Heater Oven Trouble	• Heater does not heat.	• Consult the authorized distributor.
Communication error	• Broken the internal device	• Consult the authorized distributor.
Temperature Sensor NG	• Temperature Sensor may be damaged.	• Consult the authorized distributor.

Power Supply

- (1) Power does not turn on when pressing ON/OFF key
 - The battery may not be charged. Charge is performed.
- (2) Power does not turn off when pressing ON/OFF key
 - Press and hold the key until the LED color changes from green to red.
- (3) Few splices can be made with a fully charged battery pack
 - If the power saving function is not enabled, battery power degrades quicker. Always enable it to conserve power usage.
 - The battery pack has reached the end of its service life. Install a new battery pack.
 - The battery pack uses chemical reaction. The capacity decreases at low temperature, especially at lower than 0 degree C.
 - At high altitude, the arc discharge current is increased. In this condition, battery power degrades quicker due to large power consumption.
- (4) “CHARGE” LED on blinks during battery recharge
 - The battery pack has a fault or has reached the end of its service life. Install a new battery pack. If the LED blinks again after install, contact the authorized distributor.
 - The battery pack has been used under the environment (especially 40 degrees C or more) where temperature is high, or direct rays.
- (5) Method to change the power saving function settings
 - Refer to [Machine Settings] function.
- (6) Battery indicator is not displayed.
 - At the time of AC adaptor use, a battery indicator is not displayed on a screen.

Splicing Operation

- (1) Error message appears on monitor
 - Refer to [Error Message List] function.
- (2) Inconsistent splice loss / High splice loss
 - Clean the V-grooves, fiber clamps, wind protector mirrors, and objective lenses.
 - Replace the electrodes.
 - “High Estimated Loss” error message section in the [Error Message List].
 - If the fiber has curl or bend memory, position the fiber so the crown (curve) of the memory is turned downward.
 - The splice loss varies according to the cleave angle, arc conditions and fiber cleanliness.
 - If the splice loss is still too high or inconsistent after performing the above-mentioned remedies, contact the authorized distributor. Regular service (at least once a year) is recommended to maintain high splicing quality.
- (3) Confirmation of splicing procedures
 - Refer to [Basic Operation] function.
- (4) Monitor suddenly turned off
 - The power saving function is automatically enabled when using a battery pack. The splicer switches to the power saving state after an extended period of splicer inactivity. Press any key to return to the normal state. To change the length of time before the splicer switches to the power saving state, Refer to [Machine Settings] function.
- (5) Splicer power suddenly turned off without “Low Battery” message
 - The power saving function is automatically enabled when using a battery pack. The splicer turns the splicer power off after an extended period of splicer inactivity. Press **ON/OFF** key to turn on the splicer again. To change the length of time before the splicer turns the splicer power off, section [Machine Settings] function.
- (6) Method to initialize arc condition of Splice mode
 - Refer to [Initialization in the edited parameter] in [Splice Settings].

- (7) Error message can be over-ridden
 - See Section [Splice Settings] to not allow error message override.
- (8) Unable to change Arc Power and Arc Time
 - The settings cannot be changed in AUTO modes.
 - If using the “Other Mode”, the Arc Power and Arc Time may be locked by administrator, preventing them from being changed.
- (9) Method to set Pause
 - See Section [Splice Menu] in [Splice Mode].
- (10) Method to display Cleave Angle, Fiber Angle / Offsets
 - See Section [Splice Settings]. The fiber angle is not displayable in the SM, DS, MM or AUTO mode.
- (11) Incorrect splice mode selected and used in AUTO mode
 - The AUTO mode can detect only standard SM, DS, MM and NZDS fibers. When splicing specialty fibers, the AUTO mode may identify them incorrectly.

Tube-heating Operation

- (1) Fiber protection sleeve does not shrink completely
 - Extend the heating time. Refer to [Heater Mode].
- (2) Heater LED on panel keyboard blinks
 - Pressing the **HEAT** key during heating causes the LED to blink. The tube heater is turned off if the **HEAT** key is pressed again. If, after 2 seconds have gone by without pressing the **HEAT** key again, the LED stays on continuously and the heater returns to its normal state. The LED will turn off when the heat cycle is completed.
 - If the heating temperature does not reach its inputted setting, the LED blinks and the alarm sounds. If this happens, contact the authorized distributor.
- (3) Fiber protection sleeve adhered to heating plate after shrink
 - Use a cotton swab or a similar soft tip object to push and remove the sleeve. If the black coating is removed, contact your authorized distributor.
- (4) Method to initialize heating condition of Heater mode
 - See Section [Referring to or editing Heater Mode].
- (5) Method to cancel heating process
 - RESET** key does not cancel the heater. Press **HEAT** key twice to cancel the heating process.

Supervising

- (1) What functions can be disabled
 - See Section [Menu Lock Settings].
- (2) Method to lock “selection” or “editing” of Splice or Heater mode
 - See Section [Menu Lock Settings].
- (3) Method to set parameters of Splice or Heater mode from a PC
 - Refer to the communication software “Data Connection” included in CD-ROM.
- (4) Forgot password
 - Contact the authorized distributor.

Other Functions

- (1) Method to hide messages on [READY] screen
 - Change the fiber image from X/Y view to X magnified view or Y magnified view by pressing X/Y key.
- (2) Too many repetitions until “Test Finish” indicated in [Arc Calibration]
 - The splicer needs to repeat the arc calibration after replacing the electrodes or when the environmental conditions change drastically. The number of arc calibrations can be set to a specific amount. When the splicer completes the set amount of calibrations, it indicates “Test Finish”. However, this does not mean it is completely calibrated.
- (3) “Test Finish” is never indicated after many repetitions in [Arc Calibration]
 - Execute [Stabilize Electrodes] function in [Maintenance Menu]. If the splicer still does not indicate “Test Finish”, replace the electrodes. See section [Replace Electrodes] function.
- (4) No arc power change after [Arc Calibration]
 - An internal factor is calibrated and adjusted for the specific arc power selected. The displayed arc power in each splice mode does not change.
 - The calibration results affect all splice modes.
- (5) Method to input different comments after each splice in splice results data
 - See section [Splice Memory Comment].

Guarantee

1. Guarantee period and limits

If the splicer becomes out of order within one year from the date of delivery, we will repair it free of charge. However, note that repairs will be charged for the following cases regardless of the guarantee period:

- (1) Trouble or damage due to natural disaster.
- (2) Trouble or damage due to mishandling.
- (3) Trouble or damage due to handling in disregard of the operating procedures or instructions described in the instruction manual.
- (4) Consumable items (discharge electrodes etc.)
Please note that the memory of the splice results, parameters, etc. may be deleted during the repair.
- (5) Trouble or damage due to abnormal voltage supply.
Most cases of damage to the AC adapter from an abnormal power supply occur within the warranty period. The specification of AC input voltage is up to AC240V (340V-peak). For this reason, Fujikura Ltd. will provide a warranty replacement of the AC adapter only one time. In a second AC adapter is damaged during the warranty period, Fujikura Ltd. will not replace it free of charge.

2. Before shipping the splicer

Please consult the authorized distributor first.

3. Necessary information needed for repair

Include documentation with the splicer informing us of the details listed below.

- (1) Your full name, section, division, company, address, phone number, fax number and e-mail address.
- (2) Model name and serial number of the splicer.
- (3) Problems encountered
 - What problems did your splicer get into and when?
 - What is its present operational state?
 - The state of the monitor and the contents of the relevant error message.Etc.

4. Transporting the splicer

Since the splicer is a high-precision machine, always use the original carrying case for transportation and storage in order to protect it against humidity, vibration and shock. When requesting splicer repair, please send it, along with its accessories, in its original carrying case.

5. Note for Repair

Please note the memory contents, such as splicing results, splice mode, etc., may be lost depending on the kind of repair.

Contact Address

Inquiries concerning products should be made to the authorized distributor or one of the following:

Fujikura Europe Ltd.
C51 Barwell Business Park
Leatherhead Road, Chessington, Surrey KT9 2NY
England
Tel. +44-20-8240-2000 (Service: +44-20-8240-2020)
Fax. +44-20-8240-2010 (Service: +44-20-8240-2029)
URL <http://www.fujikura.co.uk>

AFL Telecommunications
260 Parkway East
Duncan, SOUTH CAROLINA 29334
U.S.A.
Tel. +1-800-235-3423 (Service: +1-800-866-3602)
Fax. +1-864-433-5560 (Service: +1-800-433-5452)
P.O.Box 3127 Spartanburg, SC 29304-3127
URL <http://www.AFLglobal.com>

Fujikura Asia Ltd.
438A Alexandra Road, #08-03 Blk A Alexandra Techno Park,
SINGAPORE, 119967
Tel. +65-6-2711312 Fax. +65-6-2780965
URL <http://www.fujikura.com.sg>

Fujikura Ltd.
Optical Fiber & Equipment Department
International Sales & Marketing
1-5-1 Kiba, Koto-ku, Tokyo 135-8512
Japan
Tel. +81-3-5606-1164 Fax. +81-3-5606-1534
URL <http://www.fujikura.co.jp>

----- End of Document -----