

### Table of Contents

<b>Title</b>	<b>Page</b>
Introduction .....	3
Safety Information .....	4
The Calibrator Structure .....	7
LCD Display .....	8
Turning the Calibrator On .....	9
Measuring DC Volts (V and COM jack) .....	9
Sourcing DC Volts (V and COM jack) .....	10
Measuring DC mA (mA and COM jack) .....	11
Measuring DC mA with Loop Power (LOOP and mA jack) .....	12
Using the Current Output Modes .....	13
Sourcing mA .....	13
Simulating a Transmitter .....	15
Maintenance .....	16
In Case of Difficulty .....	16
Cleaning .....	16
Calibration .....	16
Replacing the Fuses .....	17

<b>Title</b>	<b>Page</b>
Replacing the Battery -----	19
Specifications -----	21
DC Voltage and DC Current Input -----	21
DC Voltage and DC Current Output -----	22
General Specifications -----	23

### Introduction

The Uni-Trend UT712 Volt/mA Calibrator is a source and measurement tool for 0 to 20mA current loop testing and DC Voltage from 0 to 20V. The calibrator does not source and measure simultaneously.





Your calibrator has a unique design and large LCD can read the data clearly.

Your calibrator is supplied with the following:

User Manual	1 piece
Test Leads	1 set
Alligator Clip	1 set
Carrying Bag	1 piece
9V alkaline battery (ANSI/NEDA 1604A or IEC 6LR61)	1 piece

If the calibrator is damaged or something is missing, contact the place of purchase immediately.

### International Symbols

Symbol	Meaning
	Earth ground
	Refer to this user manual for information about this feature.
	Battery
	Double insulated
	Conforms to European Union directives.

### Safety Information

Use the calibrator only as specified in this user manual, otherwise the protection provided by the calibrator may be impaired.

A **Warning** identified conditions and actions that pose hazard(s) to her user.

### **Warning**

To avoid possible electric shock or personal injury:

- Never apply more than 30V between any two jacks (terminals), or between any jack and earth ground.
- Make sure the battery door is closed before you operate the calibrator.
- Remove test leads from the calibrator before you open the battery door.
- Do not operate calibrator if it is damaged.
- Do not use or store the calibrator in an environment of high temperature, humidity, explosive, inflammable and strong magnetic field. The performance of the Meter may deteriorate after dampened.
- When servicing the calibrator, use only specified replacement parts.
- Use the proper jacks, function, and range for your measurement or output application.
- To avoid false readings, which could lead to possible electric shock or personal injury, replace the battery as soon as the battery indicator () appears.
- Turn the calibrator off when it is not in use and take out the battery when not using for a long time.

- **Constantly check the battery as it may leak when it has not been using for some time, replace the battery as soon as leaking appears. A leaking battery will damage the calibrator.**
- **The internal circuit of the calibrator shall not be altered at will to avoid damage of the calibrator and any accident.**
- **When the calibrator is off, the jacks cannot connect to any loading or they must not be short circuit between jacks.**  
**When the calibrator is carrying out measurement, do not contact any bare cable, connector, used jacks or the circuit under test.**

### The Calibrator Structure

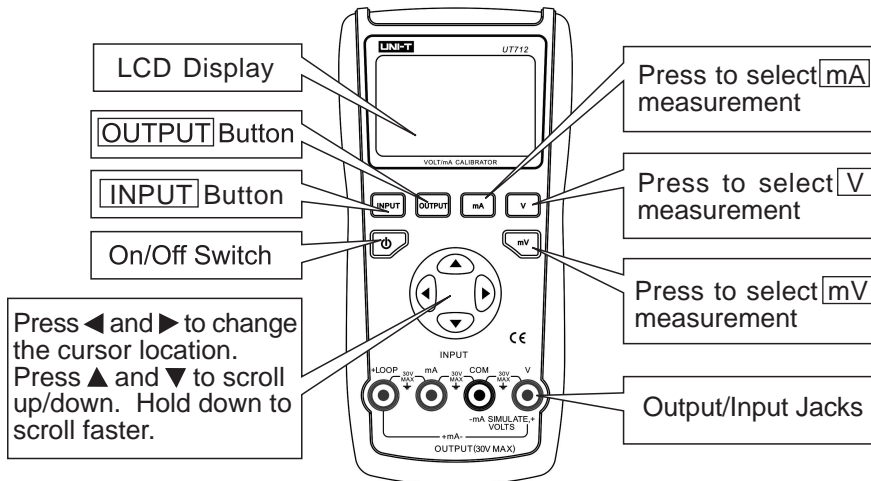

Figure 1

### LCD Display

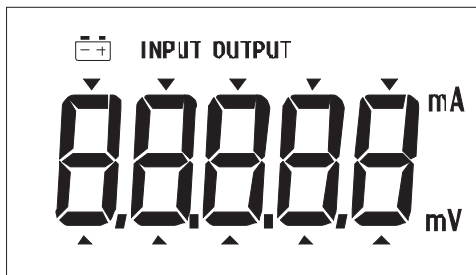



Figure 2

<b>OUTPUT</b>	The calibrator is in output mode
<b>INPUT</b>	The calibrator is in input mode
<b>mV, V, mA</b>	The measurement unit of the current reading
	Battery is low. Replace the battery
	The current cursor location



### Turning the Calibrator On

Press the yellow pushbutton to turn the calibrator on and off. Turn off the calibrator when not in use.

### Measuring DC Volts (V and COM jack)

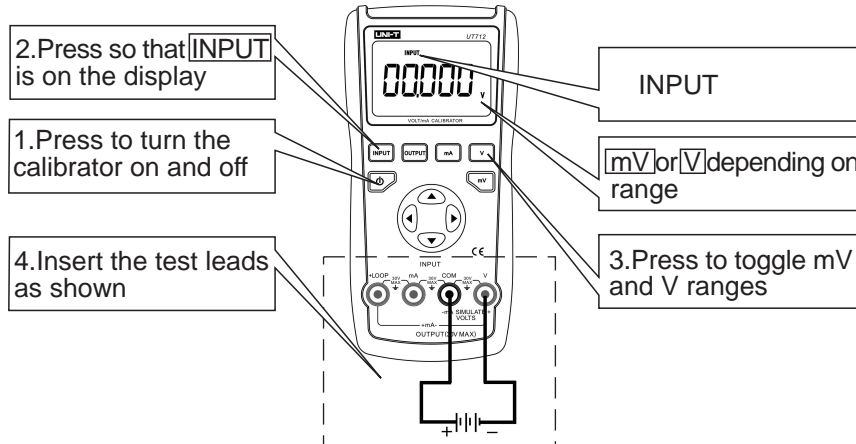
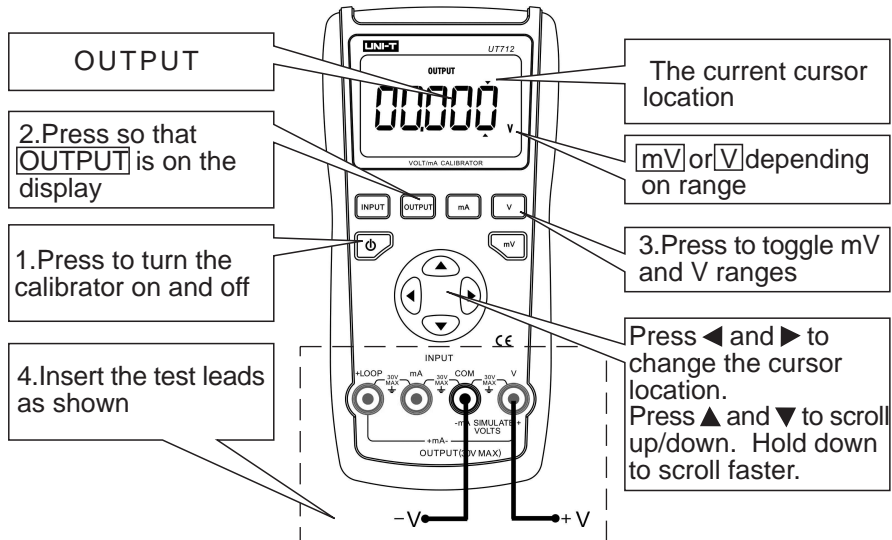

Figure 3

### Sourcing DC Volts (V and COM jack)



## Model UT712: OPERATING MANUAL

### Measuring DC mA (mA and COM jack)

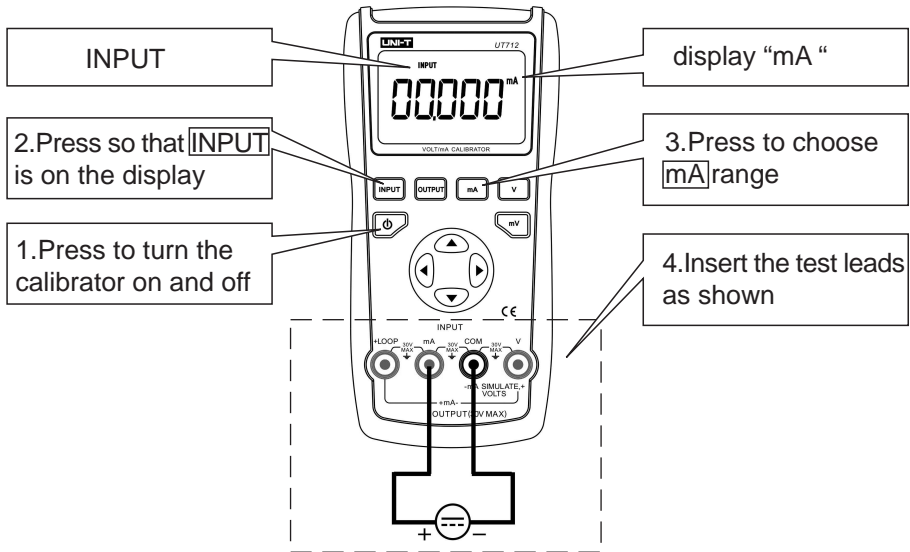

### Measuring DC mA with Loop Power (LOOP and mA jack)

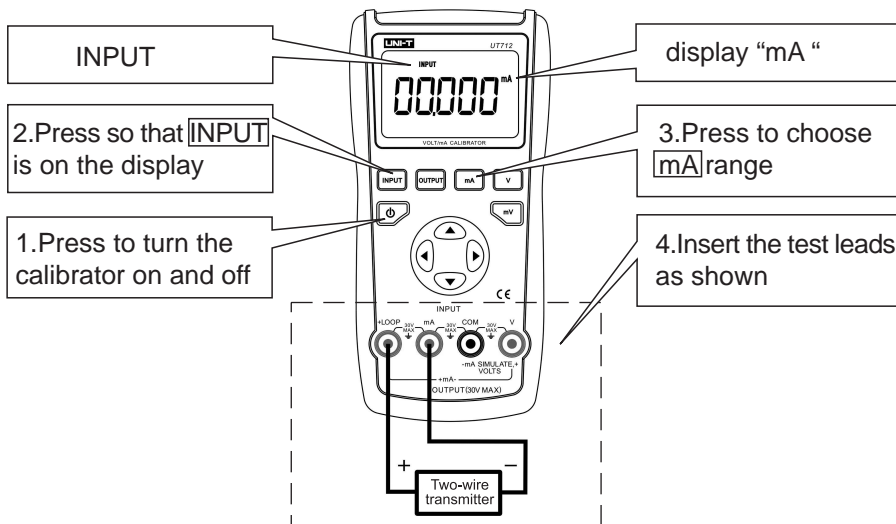

Figure 6

### **Using the Current Output Modes**

In source mode, the calibrator supplies the current. In simulate mode, the calibrator simulates a two-wire transmitter in an externally-powered current loop

#### **Sourcing mA**

Use source mode whenever you need to supply current into a passive circuit such as a current loop with no loop supply. Insert the test leads into the OUTPUT + and – mA jacks as shown on figure 7.

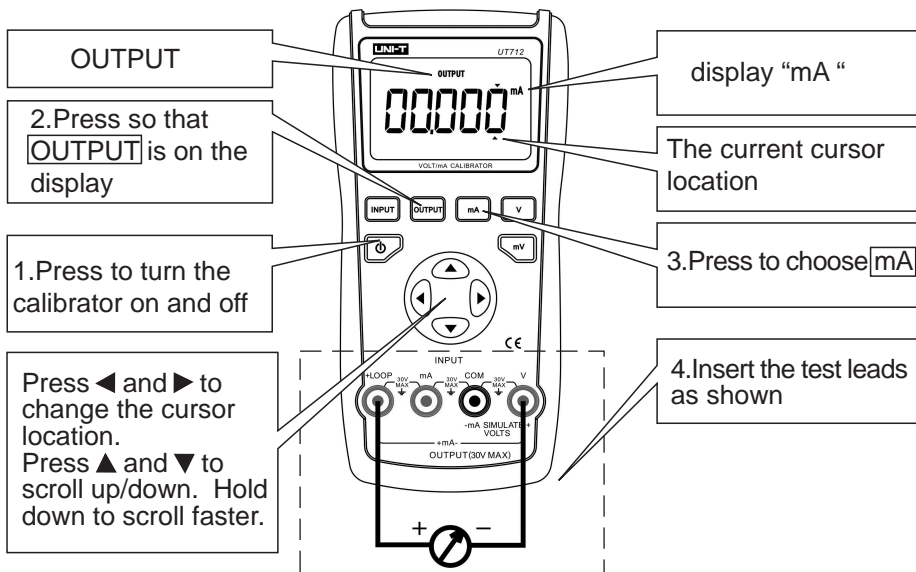

Figure 7

## Model UT712: OPERATING MANUAL

### Simulating a Transmitter

Use simulate mode when an external 24 to 30V loop power supply is available. Insert the test leads into the mA SIMULATE – and + jacks as shown below figure 8.

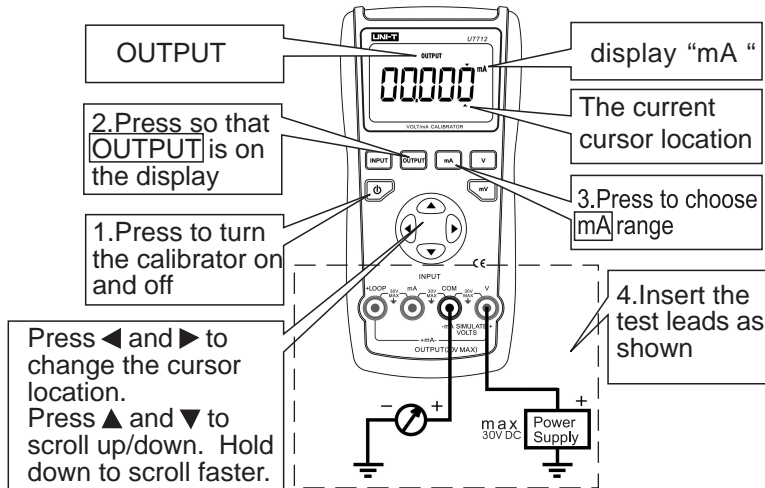

Figure 8

### Maintenance

Below provides basic maintenance information including battery and fuse replacement instruction.

#### **Warning**

**Do not attempt to repair or service your Meter unless you are qualified to do so and have the relevant calibration, performance test, and service information.**

#### In Case of Difficulty

- 1 Check the battery and test leads. Replace as necessary.
- 1 Review this user manual to make sure you are using the correct jacks and pushbuttons.

#### Cleaning

Periodically wipe the case with a damp cloth and detergent; do not use abrasives or solvents.

#### Calibration

Calibrate your calibrator once a year to ensure that it performs according to its specifications.



## Replacing the Fuses

 **Warning**

**To avoid electrical shock or arc blast, or personal injury or damage to the Meter, use specified fuses ONLY in accordance with the following procedure.**

Follow Figure 9 and proceed as follows to replace the Meter's fuse:

- 1 Turn the calibrator off and remove all connections from the terminals.
- 1 Remove the screw from the battery compartment, and separate the battery compartment from the case bottom.
- 1 Remove the three screws from the case bottom, and separate the case bottom from the case top.
- 1 Remove the fuse by gently prying one end loose, then take out the fuse from its bracket.
- 1 Install ONLY replacement fuses with the identical type and specification as follows and make sure the fuse is fixed firmly in the bracket.

Fuse 1: 125mA, 250V, fast type fuse,  
ø5x20mm

Fuse 2: 125mA, 250V, fast type fuse,  
ø5x20mm

- 1 Rejoin the case bottom and case top,  
battery compartment and case bottom,  
and install all the screws.

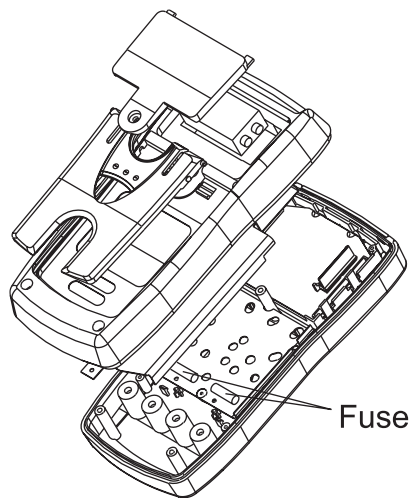

Figure 9

### Replacing the Battery

#### **Warning**

**To avoid false readings, which could lead to possible electric shock or personal injury, replace the battery as soon as the battery indicator () appears.**

Follow Figure 9 and proceed as follows to replace the battery.

- 1 Turn the calibrator off and remove all the connections from the terminals.
- 1 Remove the screw from the battery compartment, and separate the battery compartment from the case bottom.
- 1 Replace with a new 9V alkaline battery (ANSI/NEDA 1604A or IEC 6LR61)
- 1 Rejoin the case bottom and the battery compartment, and reinstall the screw,

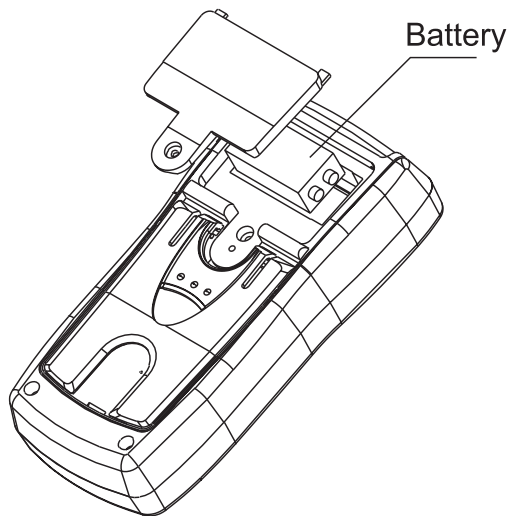

Figure 10

## Specifications

Specifications are based on a one year calibration cycle and apply from +18°C to +28°C unless stated otherwise.

### DC Voltage and DC Current Input

Input	Range	Input Range	Resolution	Accuracy
DC Voltage	200mV	(0.00~200.00) mV	0.01mV	±(0.04% readings +3 digits)
	20V	(0.000~20.000) V	0.001V	
DC Current	20mA	(0.000~20.000) mA	0.001mA	
Loop Current	20mA	(0.000~20.000) mA	0.001mA	
Input impedance: 1M (nominal). When the input value is over the range, the LCD displays OL.				

### DC Voltage and DC Current Output

Output	Range	Output Range	Resolution	Accuracy
DC Voltage	200mV	(0.00~200.00) mV	0.01mV	±(0.04% readings +3 digits)
	20V	(0.000~20.000) V	0.001V	
DC Current	20mA	(0.000~20.000) mA	0.001mA	
Simulate mode	20mA	(0.000~20.000) mA	0.001mA	
Loop Power	24V			

1 Voltage drive capability: 1mA.  
 1 **Source mode:**  
 Compliance: 700 at 20mA for battery voltage >6.5V  
 1 **Simulate mode:**  
 External loop voltage requirement: 24V nominal, 28V maximum, 12V minimum.

## General Specifications

- 1 **Resolution:**
  - DC Voltage:**0.01mV (200mV range), 0.001V (20V range)
  - DC Current:**0.001mA (20mA Range)
- 1 **Maximum voltage applied between any jack and earth ground or between any two jacks:** 30V
- 1 **Storage temperature:** -10°C to 55°C
- 1 **Operating temperature:** 0°C to 50°C
- 1 **Operating altitude:** 3000 meters maximum
- 1 **Temperature coefficient:**  $\pm 0.005\%$  of range per °C for the temperature ranges 0 to 18°C and 28 to 50°C.
- 1 **Relative humidity:** 95% up to 30°C, 75% up to 40°C, 45% up to 50°C
- 1 **Vibration:** Random 2g, 5 to 500Hz
- 1 **Shock:** 1 meter drop test
- 1 **Safety:**Complies with EN61326-1;2006,EN61326-2-2;2006
- 1 **Power requirements:** Single 9V Alkaline battery (ANSI/NEDA 1604A or IEC 6LR61)
- 1 **Size:** 193mm x 96mm x 47mm
- 1 **Weight:** around 0.45kg with battery

\*\* END \*\*

©Copyright 2008 Uni-Trend Group Limited.  
All rights reserved.

**Manufacturer:**

Uni-Trend Technology (Dongguan) Limited  
Dong Fang Da Dao  
Bei Shan Dong Fang Industrial Development District  
Hu Men Town, Dongguan City  
Guang Dong Province  
China  
Postal Code: 523 925

**Headquarters:**

Uni-Trend Group Limited  
Rm901, 9/F, Nanyang Plaza  
57 Hung To Road  
Kwun Tong  
Kowloon, Hong Kong  
Tel: (852) 2950 9168  
Fax: (852) 2950 9303  
Email: [info@uni-trend.com](mailto:info@uni-trend.com)  
<http://www.uni-trend.com>