

release date :2011.01.04

compatible with/ 2011 Porsche Cayenne None Navigation model, 2011 Porsche Panamera None Navigation model.



CDR31

Specification & Installation

Contents

1. Before the installation

1.1 Main specification	3
1.2 Features	4
1.3 Components	5
1.4 Exterior	6

2. Setup

2.1 DIP switch	7
2.2 Remote controller	8
2.3 Original buttons in car	9
2.4 Factory mode	10
2.5 Rear parking guide line	11
2.6 OSD (on screen display)	12

3. Installation

3.1 Installation diagram	14
3.2 Cautions on installation	15
3.3 Installation	16

4. Troubleshooting	19
--------------------	----

1.1 Main specification

1. Input Spec. (VIDEO INTERFACE)

- 1 x Analog R,G,B, C sync
- 1 x CVBS(REAR CAMERA) Input. (Rear camera source)
- 3 x A/V (NTSC & PAL) Input.
- 1 x LCD Input (Car system Input)

2. Output Spec.

- 3 x Audio Select (12V power comes out from 3 wires of cable by A/V1, Navigation, Rear mode)
- 1 x Audio OUTPUT
- 1 X LCD OUTPUT(LCD Operation)

3. Power Spec.

- Input Power : 10VDC ~ 16VDC
- Consumption Power : 2WATT in maximum level

4. Switching mode

- Skip function of input video : Able to skip each input source via adjusting DIP switch.
- Control by using the remote controller.
- Able to change a mode to another by using the mode switch.
- Able to change modes and get back to the OEM screen through the genuine buttons.

1.2 Features

- Plug & Play (LVDS cable enclosed)
- Able to position DVD, Navigation screen by itself
- Improvement in screen display (Interface intended for user convenience)
- Remote controller enclosed
- Able to change a mode to another via the mode switch

1.3 Components

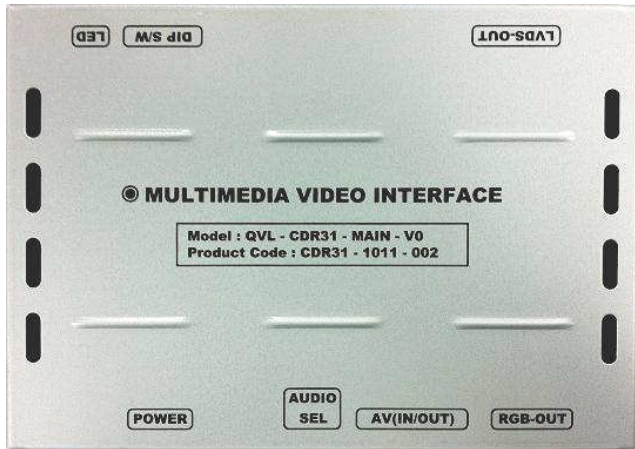

Main board x 1pc.



Mode switch x 1pc.



LVDS cable x 1pc.



Audio select x 1pc.

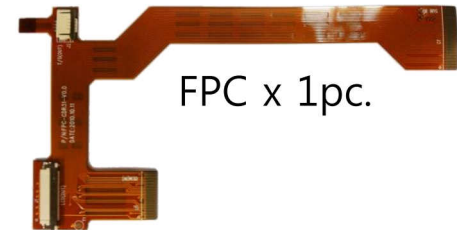

FPC x 1pc.



TOUCH cable x 1pc.

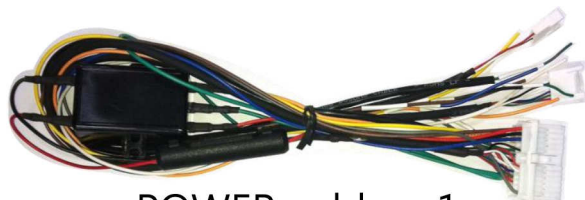

POWER cable x 1pc.



RGB cable x 1pc.

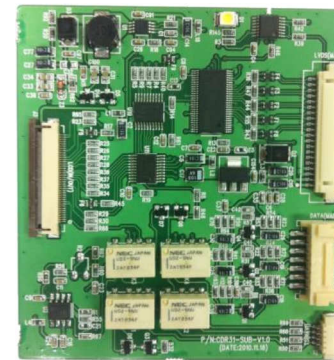

Sub board x 1pc.

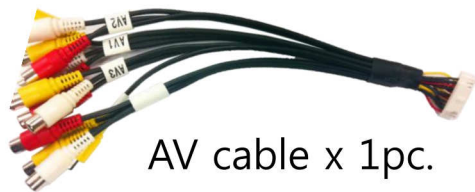

AV cable x 1pc.



IR cable x 1pc.

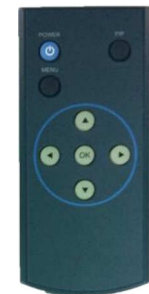

Remote Controller x 1pc.

1.4 Exterior

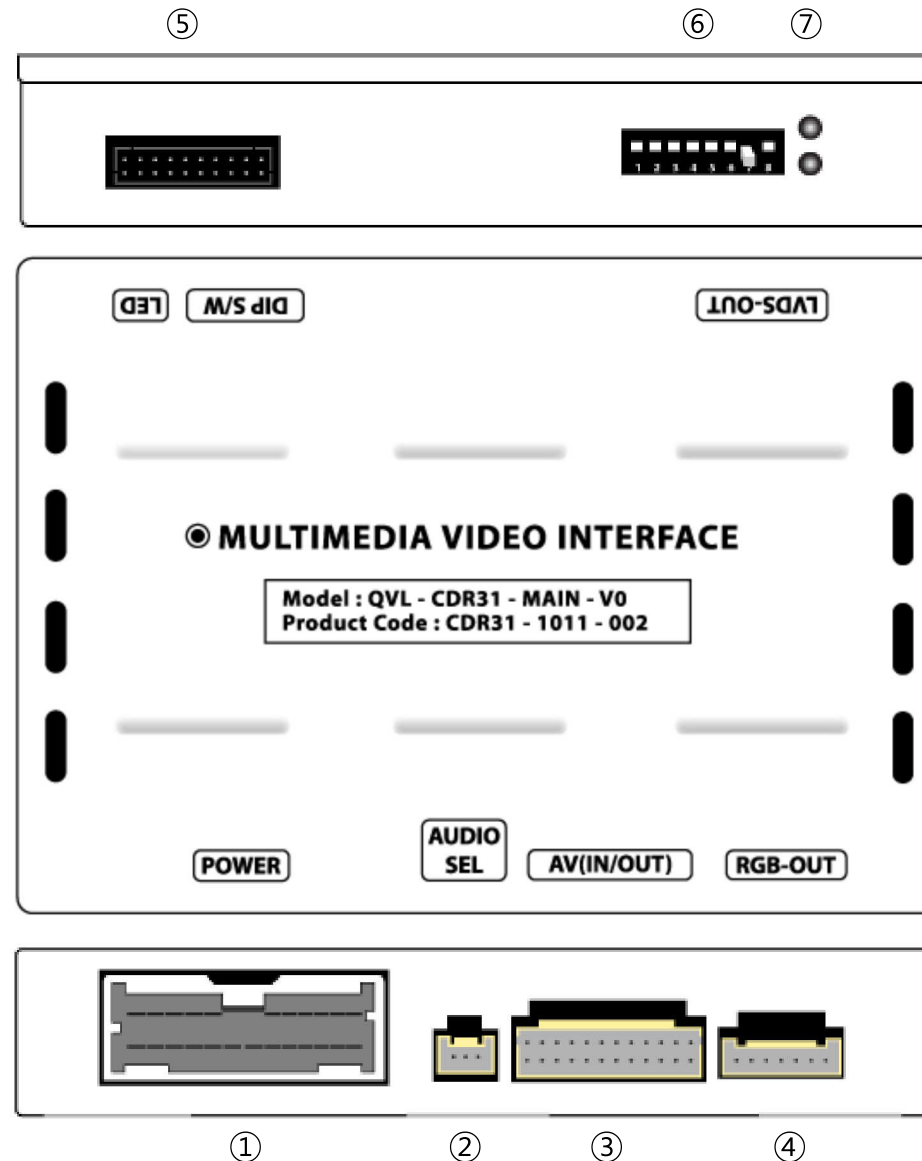

- ① POWER
- ② AUDIO SEL
- ③ AV (IN/OUT)
- ④ RGB-OUT
- ⑤ LVDS-OUT
- ⑥ DIP S/W
- ⑦ LED

2.1 DIP switch

#PIN	FUNCTION	DIP S/W Selection
1	RGB INPUT SKIP	ON : Skipping RGB Mode OFF : RGB Display
2	A/V 1 SKIP	ON : Skipping A/V 1 OFF : A/V1 Display
3	A/V 2 SKIP	ON : Skipping A/V 2 OFF : A/V2 Display
4	A/V 3 SKIP	ON : Skipping A/V 3 OFF : A/V3 Display
5	N.C	
6	N.C	
7	Rear Mode	ON : External Rear Camera OFF : OEM Rear Camera
8	OEM Navi Mute	ON : In case of OEM Navi installed OFF : In case of OEM Navi not installed

※ ON : DOWN, OFF : UP

※ DIP S/W Use Example

[CDR31]

- Use Input Mode : A/V3(DVD), Navigation (RGB)
- Rear Camera : When to be installed on CVBS
- When an original Navigation is not installed.

- ▷ DIP S/W : 1 → OFF
- ▷ DIP S/W : 2,3 → ON (INPUT MODE SKIP)
- ▷ DIP S/W : 4 → OFF (enable A/V3)
- ▷ DIP S/W : 5 → OFF
- ▷ DIP S/W : 6 → OFF
- ▷ DIP S/W : 7 → ON (enable CVBS4)
- ▷ DIP S/W : 8 → OFF



2.2 Remote controller

▲ Key Function

Key	Function
POWER & PIP	N.C
MENU	OSD MENU
OK	selection
▲	Up
▼	Down
◀	Left , if you press about 2 seconds long, you are able to approach the factory mode.
▶	Right



2.3 Original buttons in car



Button	Press	Function
Mode change	Press long	Changing modes like this sequence; NAVI-AV1-AV2-AV3-NAVI-... without the genuine screen.
	Press short	Getting back to the genuine screen.
Rest of the buttons	Press short	Directly changing from NAVI/AV modes to the genuine screen. (except for blue ones)

2.4 Factory mode

※ Factory Mode – Press long the LEFT button on the remote controller.

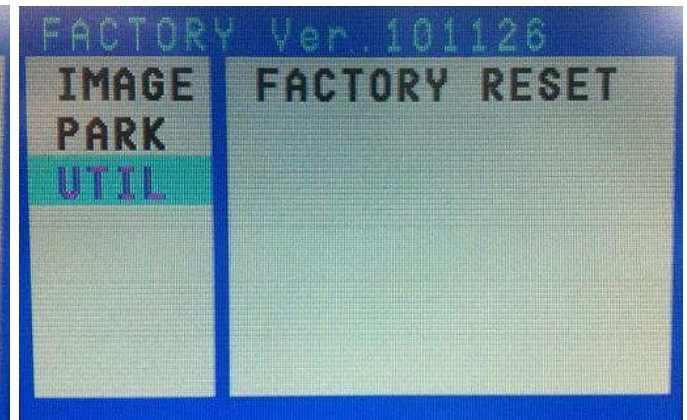
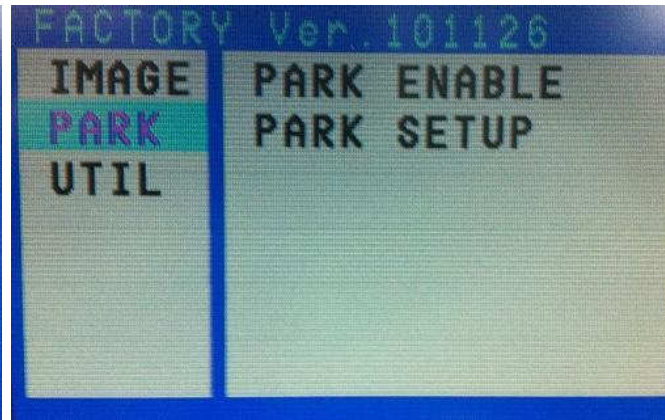
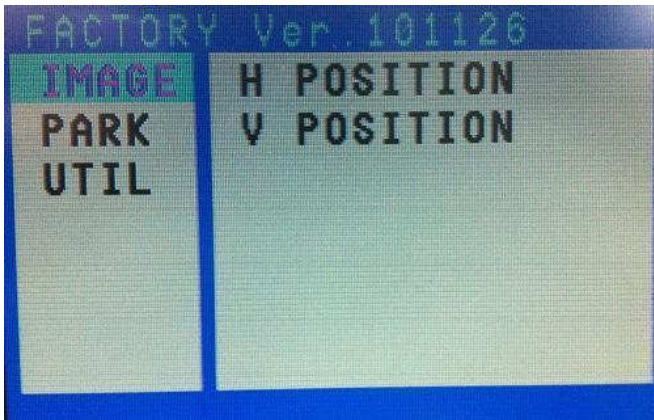

IMAGE

- H POSITION : control over the horizontal position of the screen
- V POSITION : control over the vertical position of the screen

PARK

- PARK ENABLE : able to choose whether the rear guide line is displayed or not with rear gear. (default-ON)
- PARK SETUP : able to adjust the position of the rear guide line with the remote controller. (Refer to the page#11)

UTIL

- FACTORY RESET : able to reset the data.

2.5 Rear parking guide line

※ FACTORY mode – Press long the LEFT button on the remote controller.

※ FACTORY default : PARK ENABLE-on



① Set PARK ENABLE with "ON" under FACTORY mode/
PARK menu like the left picture.

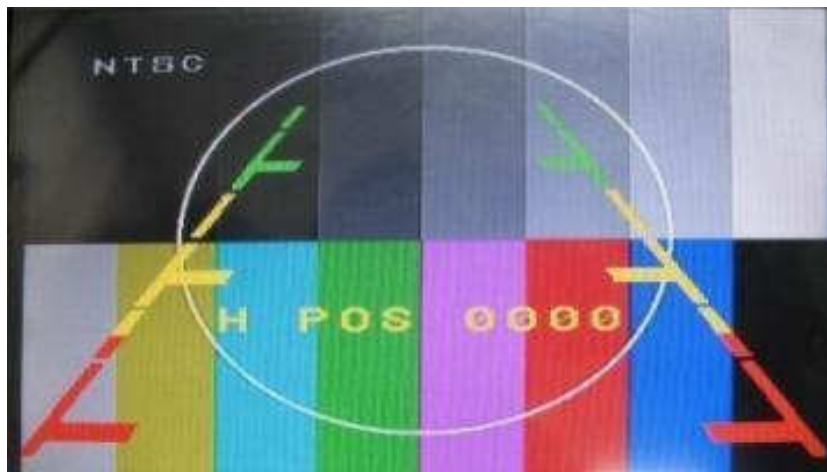

② Once you change up into rear gear after setting, there will be the rear guide line on the screen like the left picture. And move to the "PARK SETUP". Then you can change the position of that by using the remote controller.

2.6 OSD (on screen display)

※ OSD menu : Press "MENU" button on the remote controller.



Analog RGB Mode

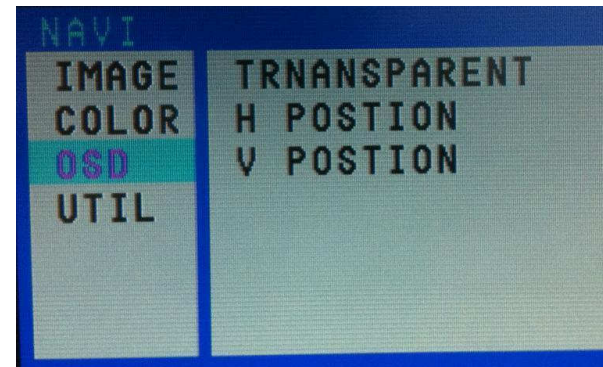

Analog RGB Mode



Video Mode

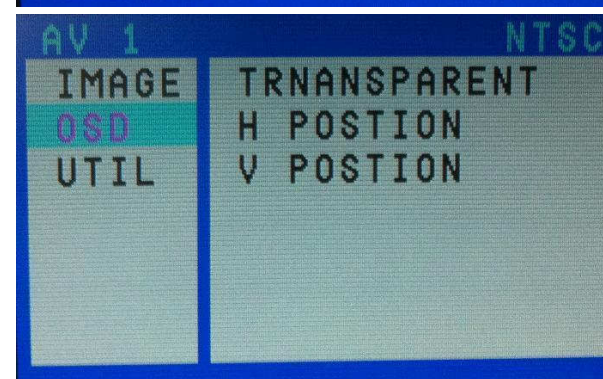

Video Mode

IMAGE

- BRIGHTNESS : able to adjust brightness of the screen
- CONTRAST : able to adjust contrast of the screen
- SATURATION : able to adjust saturation of the image
- HUE : able to adjust hue of the screen
- SHARPNESS : able to adjust sharpness of the screen
- USER IMAGE : able to make a choice among 4 set-colors of the screen

OSD

- TRANSPARENT : control over the transparency of OSD
- H_POSITION : control over the horizontal position of OSD
- V_POSITION : control over the vertical position of OSD

2.6 OSD (on screen display)

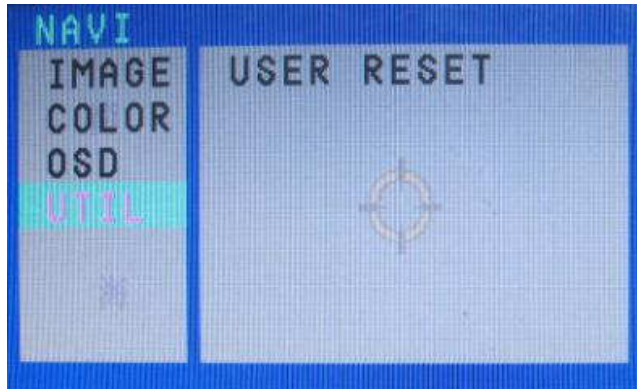

Analog RGB Mode



Analog RGB Mode



Video Mode

UTIL

- USER RESET : able to reset the whole value of the NAVI or DVD screen to the default. (not for the screen image, but for the values in OSD)

COLOR

- RED
- GREEN
- BLUE
- USER COLOR : user choice among the setting colors

3.1 Installation diagram

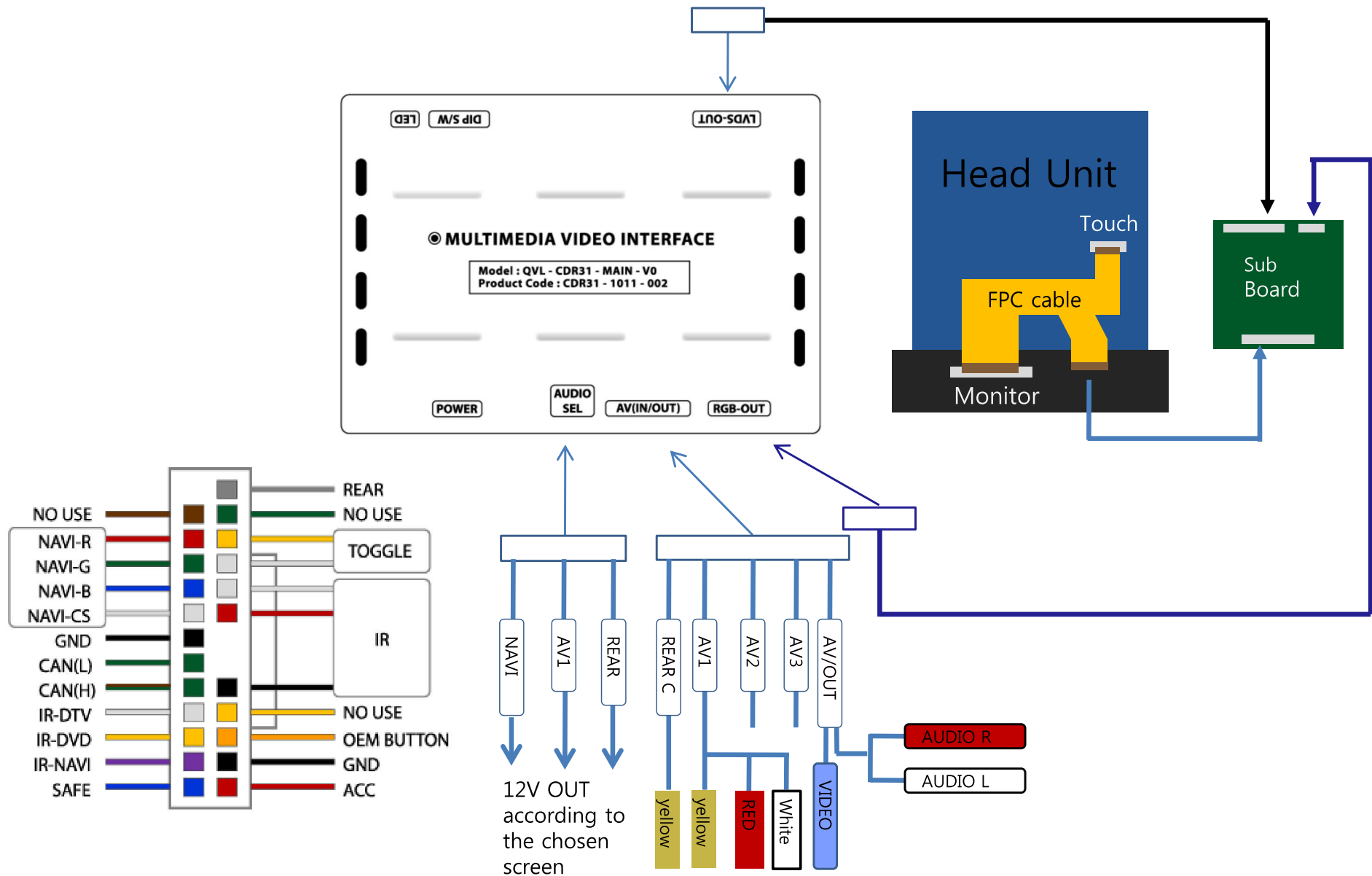

3.2 Cautions on installation

- Ignition key should be taken off before starting installation, interface power connection must be the last step in installation.
- Power cable should be separated when connecting interface.
- Should be no any electronic devices or magnetic pole around installation place.
- All steps of installation should be done by well-trained specialist.
- Dismantling without manufacturer's permission can not be guaranteed, (No permission to break attached label on the board.)
- Kindly check all parts are in the box, when receiving the product, if anything missing, inform to the supplier or manufacturer.
- According to our sales policy, any problems caused by user's mistake, careless can not be guaranteed.

3.3 Installation

3.3.1 Connection with SUB board



① Divide two cables in the marked areas after separating the front part of the head unit.

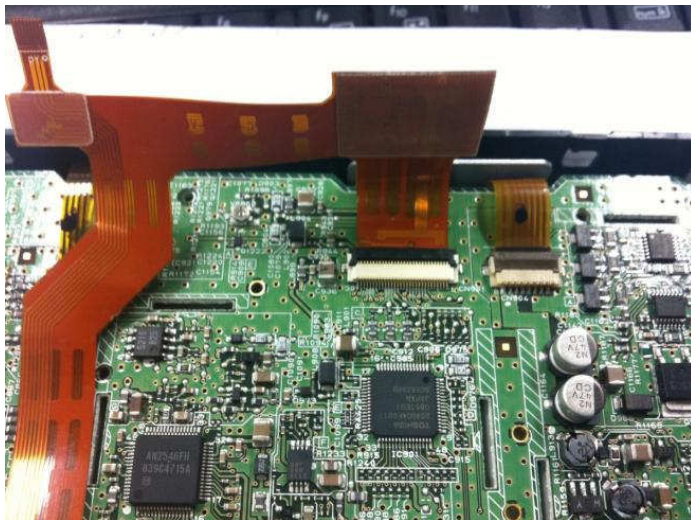

② Connect the FPC cable (enclosed in the package) after separating the original FPC cable as shown above.

3.3 Installation

3.3.1 Connection with SUB board



③ Connect the head unit after connecting the FPC cable.

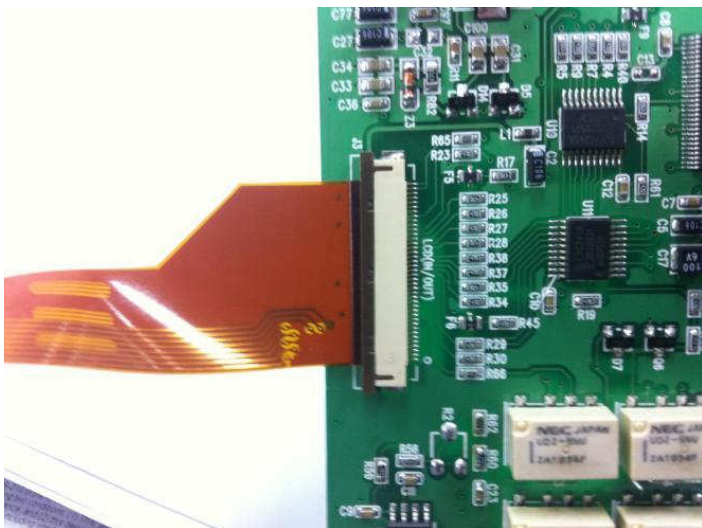

④ Connect the FPC cable to the SUB board.

3.3 Installation

3.3.2 Connection with the original button

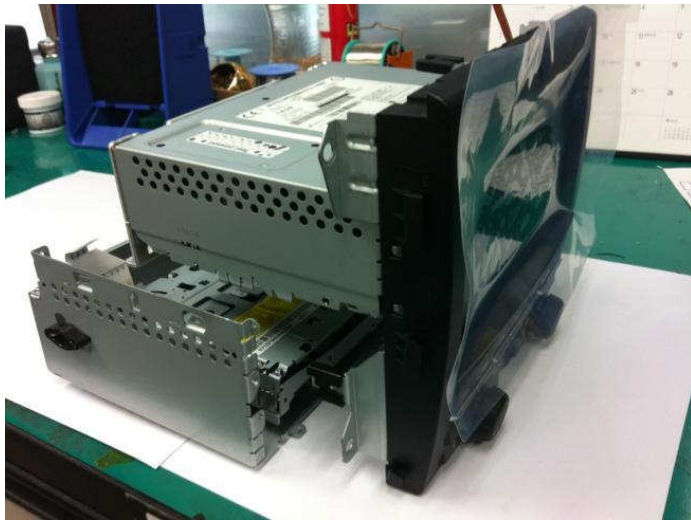

① Divide the bottom part of the head unit before soldering.

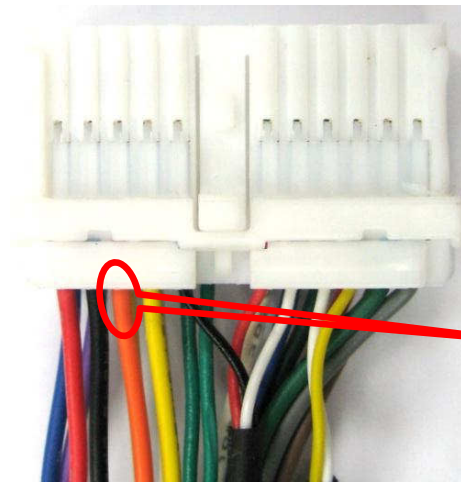
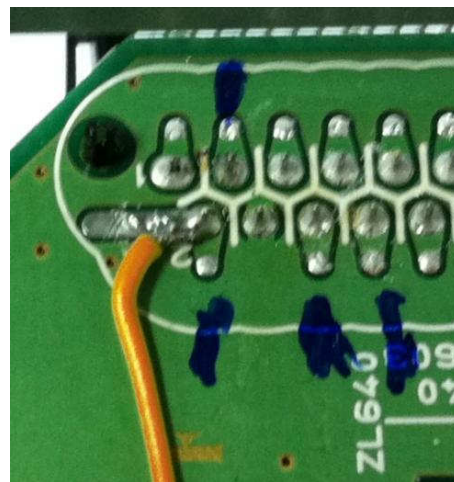
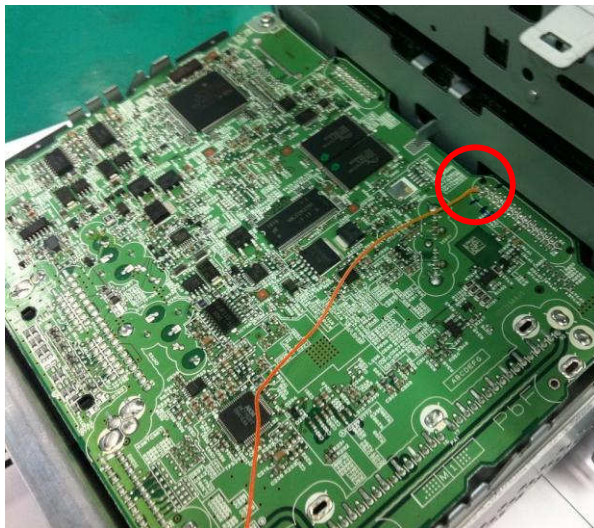

② Soldering point – connect to the pin#3 of the POWER cable.

Solder the opposite end of the orange cable in the POWER cable.

4. Troubleshooting

Q. I can not switch A/V sources.

A. Check IR or Ground cable connection. Check LED lamps in the interface, if it is not on, check power cable.

Q. All I got on the screen is black.

A. Check second LED lamp of the interface is on, if not, check A/V sources connected are working well.
(Second lamp indicates AV sources connected works well.) Check interface connection has been done well.

Q. Displayed image color is not proper. (too dim or not suitable color)

A. Try to select "INITIAL" in OSD menu, if it does not work, inform the manufacturer.)

Q. Rear camera image does NOT appear.

A. Set DIP switch #7 in "ON"

Q. Unwanted A/V mode is displayed. (A/V source switching order : OEM->RGB->AV1->AV2->AV3)

A. Check DIP Switch Setting.

Q. OEM image is not displayed.

A. Check interface's LCD In/Out cable connection. If the status keeps on, inform the manufacturer.

Q. Screen only displays white like left picture.

A. Check LCD out cable is connected well, if this status keeps, inform the manufacturer.