

3801-50

DIGITAL HiTESTER

Instruction Manual

Contents

Introduction	1
Verifying Package Contents	1
Safety Information	2
Operating Precautions	5

1 Overview 7

1.1 Product Overview	7
1.2 Features	8
1.3 Names and Functions of Parts	9

2 Measurement 15

2.1 Pre-Operation Inspection	17
2.2 Voltage Measurement	19
2.3 Current Measurement	21
2.4 Resistance Measurement	23
2.4.1 Resistance Measurement (Ω)	23
2.4.2 Conductance ($1/\Omega$) Measurement (nS)	24
2.5 Continuity Check	25
2.6 Diode Check	26
2.7 Capacitance Measurement	27
2.8 Frequency Measurement	28
2.8.1 Frequency Measurement	28
2.8.2 Frequency Counter Measurement	29
2.9 DUTY Ratio Measurement	30
2.10 Pulse Width Measurement	31
2.11 Temperature Measurement	32
2.12 Pulse Output Function	34

3 Additional Functions 37

3.1 Auto Range Function	37
3.2 Manual Range Function	38
3.3 Hold Functions	39
3.3.1 Trigger Hold Function	39
3.3.2 Refresh Hold Function	40
3.3.3 Peak Hold Function	42

3.4	Recording Function	43
3.5	Relative (REL) Display Function	45
3.6	Battery Indicator Function	46
3.7	Communications Function	47
3.8	Warning Functions	49
3.8.1	Terminal A Misconnection Warning	49
3.8.2	Overload Warning	50

4 Power On Options 51

4.1	Communications Settings	53
4.1.1	Communications Speed Setting (Baud Rate)	53
4.1.2	Parity Check Setting	53
4.1.3	Data Length Setting	54
4.1.4	Response ON/OFF Setting	54
4.1.5	Data Output ON/OFF Setting	55
4.2	Toggleing the Percentage Display (4 - 20mA/0 - 20mA)	56
4.3	Minimum Frequency Setting	57
4.4	Buzzer Sound setting	58
4.5	Toggleing the Decibel Display (dBm/ dBV)	59
4.6	Thermocouple Type Setting	60
4.7	Temperature Display Setting	61
4.8	Refresh Hold Setting	62
4.9	Auto Power Save Function	63
4.10	Display Backlight Setting	64
4.11	Reference Impedance Setting	65
4.12	Reset	66

5 Specifications 67

5.1	General Specifications	67
5.2	Accuracy	71

6 Maintenance and Service 79

6.1	Troubleshooting	79
6.2	Cleaning	81
6.3	Replacing the Battery	81
6.4	Replacing the Fuses	83
6.5	Checking the Instrument Software Version	85

Introduction

Thank you for purchasing the HIOKI "Model 3801-50 DIGITAL HiTESTER." To obtain maximum performance from the instrument, please read this manual first, and keep it handy for future reference.

Verifying Package Contents

- When you receive the instrument, inspect it carefully to ensure that no damage occurred during shipping. In particular, check the accessories, panel switches, and connectors. If damage is evident, or if it fails to operate according to the specifications, contact your dealer or Hioki representative.
- When transporting the instrument, use the original packing materials in which it was shipped, and pack in a double carton. Damage occurring during transportation is not covered by warranty.

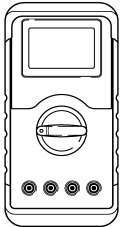

□ 3801-50 DIGITAL HiTESTER
(with protective holster/ 1)



□ 6LR61 alkaline battery
(built into the instrument/ 1)



□ Strap (1)



□ Instruction
manual (1)



□ 3851-10 TEST LEAD (1)

Options

- 3853 CARRYING CASE
- 3856-01 COMMUNICATION PACKAGE (RS-232C)
- 3856-02 COMMUNICATION PACKAGE (USB)
- 9180 SHEATH TYPE TEMPERATURE PROBE
- 9181 SURFACE TEMPERATURE PROBE
- 9182 SHEATH TYPE TEMPERATURE PROBE
- 9183 SHEATH TYPE TEMPERATURE PROBE
- 9472 SHEATH TYPE TEMPERATURE PROBE
- 9473 SHEATH TYPE TEMPERATURE PROBE
- 9474 SHEATH TYPE TEMPERATURE PROBE
- 9475 SHEATH TYPE TEMPERATURE PROBE
- 9476 SURFACE TYPE TEMPERATURE PROBE
- 9617 CLIP ON BASE*
- 9618 CLIP-TYPE LEAD*

(* not complied with the CE marking)

Safety Information





This instrument is designed to comply with IEC 61010 Safety Standards, and has been thoroughly tested for safety prior to shipment. However, mishandling during use could result in injury or death, as well as damage to the instrument. Be certain that you understand the instructions and precautions in the manual before use. We disclaim any responsibility for accidents or injuries not resulting directly from instrument defects.

Safety Symbols

This manual contains information and warnings essential for safe operation of the instrument and for maintaining it in safe operating condition. Before using it, be sure to carefully read the following safety precautions.

In the manual, the  symbol indicates particularly important information that the user should read before using the instrument.



The  symbol printed on the instrument indicates that the user should refer to a corresponding topic in the manual (marked with the  symbol) before using the relevant function.



Indicates that dangerous voltage may be present at this terminal.



Indicates a double-insulated device.



Indicates a grounding terminal.



Indicates DC (Direct Current).



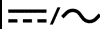

Indicates AC (Alternating Current).





Indicates DC (Direct Current) or AC (Alternating Current).

The following symbols in this manual indicate the relative importance of cautions and warnings.

 <u>DANGER</u>	Indicates that incorrect operation presents an extreme hazard that could result in serious injury or death to the user.
 <u>WARNING</u>	Indicates that incorrect operation presents a significant hazard that could result in serious injury or death to the user.
 <u>CAUTION</u>	Indicates that incorrect operation presents a possibility of injury to the user or damage to the instrument.
<u>NOTE</u>	Indicates advisory items related to performance or correct operation of the instrument.

Other Symbols

	Indicates the prohibited action.
	Indicates the reference.

Accuracy

We define measurement tolerances in terms of rdg. (reading) and dgt. (digit) values, with the following meanings:

rdg. (reading or displayed value)

The value currently being measured and indicated on the measuring instrument.

dgt. (resolution)

The smallest displayable unit on a digital measuring instrument, i.e., the input value that causes the digital display to show a "1" as the least-significant digit.

Measurement categories (Overvoltage categories)

This instrument complies with CAT III (1000 V) and CAT IV (600 V) safety requirements.

To ensure safe operation of measurement instruments IEC 61010 establishes safety standards for various electrical environments, categorized as CAT I to CAT IV, and called measurement categories. These are defined as follows.

CAT I	Secondary electrical circuits connected to an AC electrical outlet through a transformer or similar device.
CAT II	Primary electrical circuits in equipment connected to an AC electrical outlet by a power cord (portable tools, household appliances, etc.)
CAT III	Primary electrical circuits of heavy equipment (fixed installations) connected directly to the distribution panel, and feeders from the distribution panel to outlets.
CAT IV	The circuit from the service drop to the service entrance, and to the power meter and primary overcurrent protection device (distribution panel).

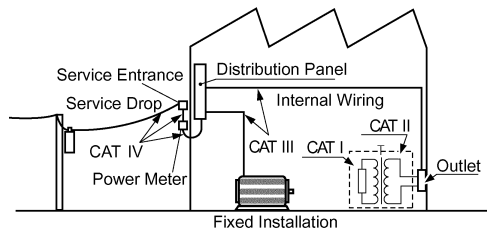

Higher-numbered categories correspond to electrical environments with greater momentary energy. So a measurement device designed for CAT III environments can endure greater momentary energy than a device designed for CAT II.

Using a measurement instrument in an environment designated with a higher-numbered category than that for which the instrument is rated could result in a severe accident, and must be carefully avoided.

Never use a CAT I measuring instrument in CAT II, III, or IV environments.

The measurement categories comply with the Overvoltage Categories of the IEC60664 Standards.

Operating Precautions



Follow these precautions to ensure safe operation and to obtain the full benefits of the various functions.

Setting up the Instrument

Operating temperature and humidity:
 0 to 50°C (32 ± 122°F), 80%RH or less (non-condensating)
 Temperature and humidity range for guaranteed accuracy:
 23 ± 5°C (73 ± 9°F), 80% RH or less (non-condensating)

Avoid the following locations that could cause an accident or damage to the instrument.

	Exposed to direct sunlight		In the presence of corrosive or explosive gases
	Exposed to high temperature		Exposed to strong electromagnetic fields
	Exposed to liquids Exposed to high humidity or condensation		Near electromagnetic radiators
	Exposed to high levels of particulate dust		Subject to vibration

Preliminary Checks

Before using the instrument the first time, verify that it operates normally to ensure that no damage occurred during storage or shipping. If you find any damage, contact your dealer or Hioki representative.



Before using the instrument, make sure that the insulation on the test leads is undamaged and that no bare conductors are improperly exposed. Using the instrument in such conditions could cause an electric shock, so contact your dealer or Hioki representative for replacements. (Model 3851-10 TEST LEAD)

Measurement Precautions



Observe the following precautions to avoid electric shock.

- Always verify the appropriate setting of the function selector before connecting the test leads.
- Disconnect the test leads from the measurement object and terminals before switching the function selector.



The terminals are not sufficiently separated. To avoid electrocution, do not touch the terminals.



For safety reasons, when taking measurements, only use the test lead provided with the instrument.

Handling this Instrument



To avoid damage to the instrument, protect it from physical shock when transporting and handling. Be especially careful to avoid physical shock from dropping.



- To avoid corrosion from battery leakage, remove the batteries from the instrument if it is to be stored for a long time.
- After use, always turn OFF the power.

Handling the Test Leads



- To avoid breaking the cables, do not bend or pull them.
- The ends of the leads are sharp. Be careful to avoid injury. Fit the protective pin cap when the product is not in use.
- Keep the cables well away from heat sources, as bare conductors could be exposed if the insulation melts.

Overview

1

1

Overview

1.1 Product Overview

The 3801-50 is a multifunction, high-performance digital multimeter that can be used for voltage (DC/AC/AC+DC), current (DC/AC/AC+DC), resistance, continuity, diodes, electrostatic capacity, frequency, frequency counter, duty ratio, pulse width, and temperature measurement. In addition, this instrument is equipped with a pulse output function that can be used to check a variety of pulse signal instruments. Furthermore, this instrument can be controlled by computer and transfer measurement data to the computer when the optional 3856-01/02 is used.

Measurement Capabilities

Voltage Measurement	(19 page)
Current Measurement	(21 page)
Resistance Measurement	(23 page)
Continuity Check	(25 page)
Diode Check	(26 page)
Capacitance Measurement	(27 page)
Frequency Measurement	(28 page)
DUTY Ratio* Measurement	(30 page)
Pulse Width Measurement	(31 page)
Temperature Measurement	(32 page)

* DUTY ratio

The duty ratio is the ratio between the pulse width and the pulse cycle. This instrument displays this ratio in terms of 100 (%).

Plus slope pulse width Minus slope pulse width

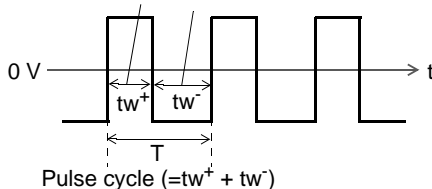

1.2 Features



High-performance Handheld DMM

The 3801-50 can display a maximum count of 51,000. It can even measure distorted waveforms with high-precision using true RMS measurement. The basic accuracy for DC voltage measurement is $\pm 0.025\%$ rdg. ± 5 dgt.



Safe Design Compliant with CE Marking Standards

The 3801-50 is compliant with international safety standards (IEC61010-1 measurement categories CAT III (1000 V) and CAT IV (600 V)) and EMC related standards.



Comprehensive Additional Functions

The 3801-50 is also equipped with a wealth of additional functions ranging from simple support for measurement to easy analysis.

❖ See Chapter 3 Additional Functions (page 37)

Refresh Hold Function	The measured value is locked automatically and then stored, even if you let go of the test leads.
Trigger Hold Function	The measured value is stored each time that a key is pressed.
Peak Hold Function	Captures transient voltage or current spikes caused by surges, etc.
Recording Function	Switches the display to maximum measured value, minimum value, average value, or current value.
Relative Display Function	Displays the deviation from the reference value.
Back Light Function	Brightens the display in dark conditions (EL type).
Communications Function	Permits connection to a computer for data analysis. (Requires RS-232C/USB and the optional 3856-01/02.)
Pulse Output Function	Outputs a pulse signal for checking various types of pulse-controlled equipment.

1.3 Names and Functions of Parts

The name and function of each part of the 3801-50 is described below.

1

Overview

Front Panel

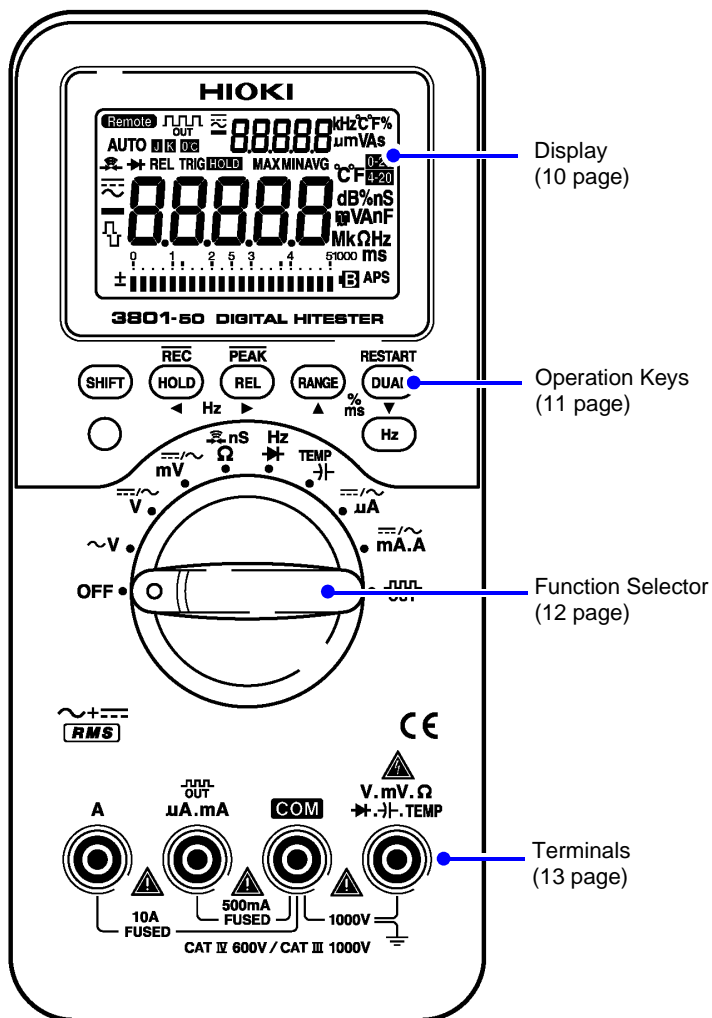

Display

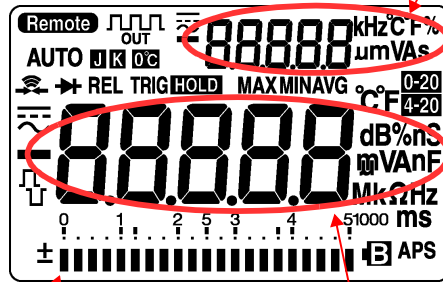

Sub display and units

Bar graph

Main display and units





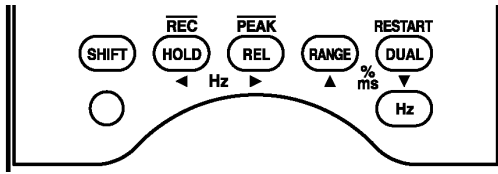

Remote	Lights when under remote control.
	Lights when the pulse output function is being used.
	Lights when the DCV measurement or DCA measurement function is being used.
	Lights when the ACV measurement or ACA measurement function is being used.
	Lights when the AC+DCV measurement or AC+DCA measurement function is being used.
AUTO	Lights when the auto range function is being used.
K / J / 0°C	Indicates the thermocouple type for temperature measurement. The type that is selected lights.
	Lights when the diode check function is being used.
	Lights when the continuity check function is being used.
REL	Lights when the relative value display function is ON.
TRIG HOLD	Lights when the trigger hold function is ON.
MAX	Lights when the maximum value is being displayed. (Peak hold, recording function)
MIN	Lights when the minimum value is being displayed. (Peak hold, recording function)
AVG	Lights when the average value is being displayed. (Recording function)
0-20	Lights when the percentage conversion display is 0 to 20mA
4-20	Lights when the percentage conversion display is 4 to 20mA
	Lights when the DUTY ratio measurement or pulse width measurement function is being used.
	Low battery indicator. This lights when the battery needs to be replaced.
APS	Lights when the auto power save function is ON.

Operation Keys



1

Overview

	SHIFT key
	Locks the current measured value. (Hold function) Holding this key down toggles the recording function ON/OFF.
	Displays the relative value. (Relative value display function) Holding this key down toggles the peak hold function ON/OFF.
	Changes the measurement range. (Manual range) Holding this key down sets the auto range function.
	Displays different measured values in the main display and the sub display in combination. In peak hold mode and recording mode, pressing this key restarts the instrument.
	Selects the frequency, duty ratio and pulse width in the main display. Holding this key terminates the selection.
	Toggles the backlight ON/OFF. Holding this key down displays the battery level.

Function Selector

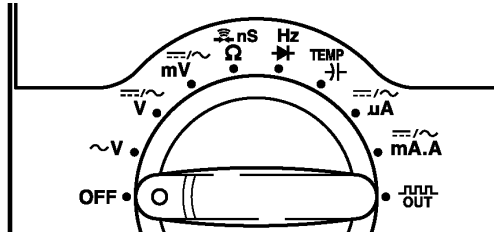

OFF	Pressing this key turns the instrument off.
~V	AC voltage measurement function
V	Voltage measurement function Use the SHIFT key to select DC, AC, or AC+DC.
mV	Voltage measurement function up to 1000 mV. Use the SHIFT key to select DC, AC, or AC+DC.
Ω	Resistance measurement function Use the SHIFT key to select either continuity check or the nS measurement function.
➤	Diode check function Use the SHIFT key to select the frequency counter function.
⌋⌋	Capacitance measurement function Use the SHIFT key to select the temperature measurement function.
μA	Current measurement function up to 5100 μA. Use the SHIFT key to select DC, AC, or AC+DC.
mA.A	Current measurement function Use the SHIFT key to select DC, AC, or AC+DC.
⌋⌋⌋⌋ OUT	Pulse output function

Terminals

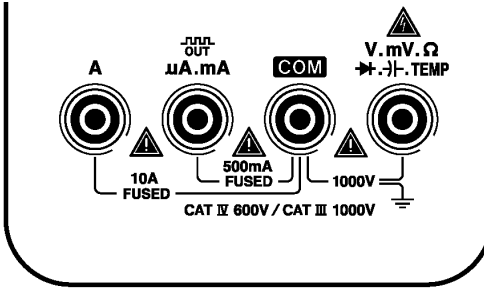

1

Overview

A Terminal	Terminal used for current measurement. (A function) Connect the read test lead.
μA.mA Terminal	Terminal used for current measurement and for pulse output. (μA, mA, pulse output function) Connect the read test lead.
COM Terminal	Common terminal used for all measurements. Connect the black test lead.
V Terminal	Terminal used for voltage measurement, resistance measurement, diode check, capacitance measurement, and temperature measurement. Connect the read test lead.

Rear Panel

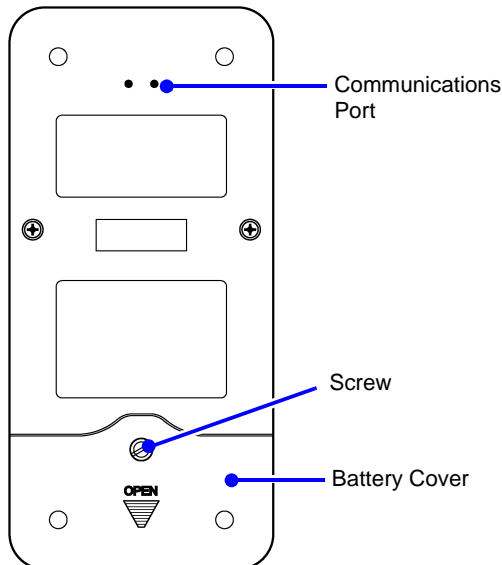

Holster

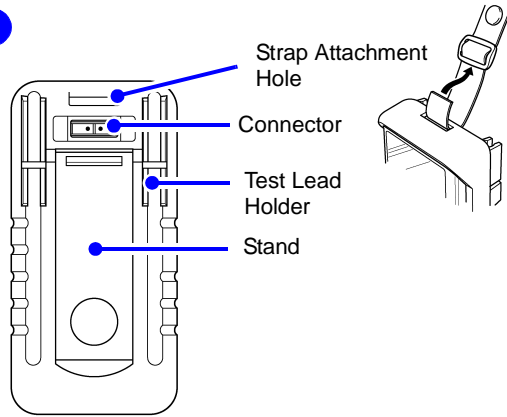

Strap Attachment Hole	Pass the strap provided through the hole in the holster to secure the 3801-50 for portable use. The strap can be used to suspend the instrument from a belt or hook when there is no place to set it down.
Connector	This connector is for the optional communications cable. If you remove instrument from the holster, this connector will also be detached. Be careful not to lose the connector.
Test Lead Holder	These lock the test leads in place. You can lock one test lead in place and then carry the instrument around while taking measurements.
Stand	Pull out the stand in order to set the instrument down in a standing position.

This instrument includes the holster as standard equipment.

Because the holster is made of a soft material, it will absorb external shocks and protect the instrument.

Remove the instrument from the holster before attempting to change the battery or the fuse. After replacing the battery or fuse, be sure to return the instrument to the holster before starting to use the instrument again.

! CAUTION

Do not apply heavy downward pressure with the stand extended. The stand could be damaged.

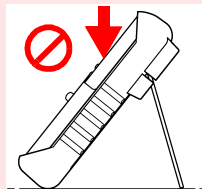

Measurement

2

DANGER

Observe the following precautions to avoid electric shock.

- Always verify the appropriate setting of the function selector before connecting the test leads.
- Disconnect the test leads from the measurement object before switching the function selector.
- The maximum input voltage is 1000 VDC, 1000 Vrms (sin) or 10^7 VHz. Attempting to measure voltage in excess of the maximum input could destroy the instrument and result in personal injury or death.
- The maximum input current is as follows;
A terminal: Continuous up to 10 A AC/DC, no more than 30 seconds up to 20 A AC/DC.
mA terminal: 510 mA AC/DC
Never exceed this limit, as doing so could result in destruction of the instrument and personal injury or death.
- The maximum rated voltage between input terminals and the ground is as follows;
CAT III: DC1000 V, AC1000 Vrms (sin) or 10^7 V · Hz
CAT IV: DC600 V, AC600 Vrms (sin) or 10^7 V · Hz
Attempting to measure voltages exceeding this level with respect to ground could damage the instrument and result in personal injury.
- To avoid electrical shock, be careful to avoid shorting live lines with the test leads.
- For safety, test lead connections must always be made at the secondary side of a circuit breaker.

2



The terminals do not have sufficient spatial isolation. To avoid electrocution, do not touch the terminals.



For safety reasons, when taking measurements, only use the test lead provided with the instrument.

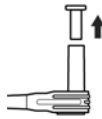

In order to protect the tips of the test leads, the test leads are capped when the unit is shipped from the factory. Be sure to remove the caps before using the test leads.

2.1 Pre-Operation Inspection



Before using the instrument the first time, verify that it operates normally to ensure that no damage occurred during storage or shipping. If you find any damage, contact your dealer or Hioki representative.

2

Measurement

Inspection

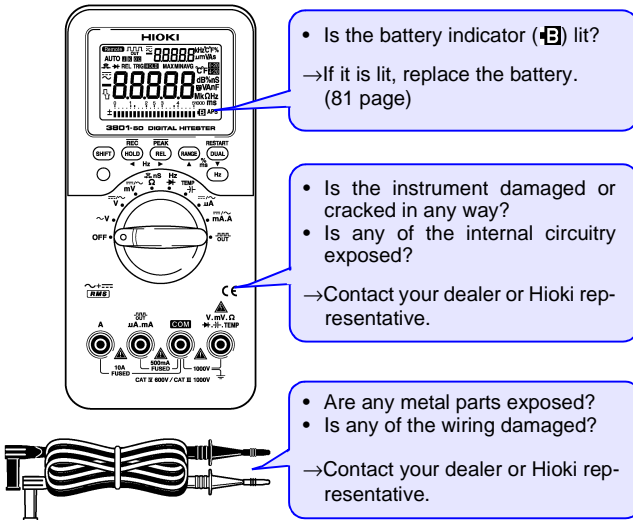

Operation Check

If the operation check reveals any abnormalities, stop the check immediately and do not use the instrument.

Required equipment:

- Model 3801-50 (this instrument)
- Model 3851-10 TEST LEAD
- AC power receptacle (100 V AC 50/60Hz commercial power supply)

1. Set the function switch to "Ω".
2. Press the **SHIFT** key to conduct the continuity check. (⚡ lights.)

2.1 Pre-Operation Inspection

3. Connect the red test lead to the V terminal, and the black test lead to the COM terminal.

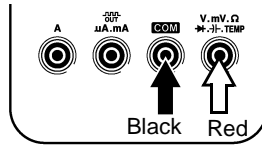

4. Short the tips of the red and black test leads by touching them together.

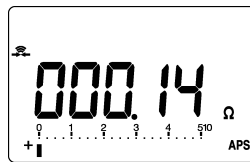

- Buzzer sounds.
 - Value stabilizes around 0 Ω.
- OK

5. Set the function switch to "ACV". (~ lights.)
6. Press the **DUAL** key so that the measured voltage appears in the main display and the measured frequency appears in the sub display.
7. Insert the test lead tips into the openings of the AC receptacle.

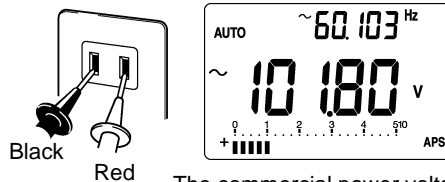

The commercial power voltage appears on the main screen and the commercial power frequency appears on the sub screen.

NOTE

This procedure only partially confirms the operation of this instrument. Periodic calibration is necessary in order to ensure that this instrument operates according to its product specifications.

2.2 Voltage Measurement



CAUTION

- Note that the instrument may be damaged if voltage or current the measurement range.
- When the power is turned off, do not apply voltage or current to the measurement terminal. Doing so may damage the instrument.

2

Measurement

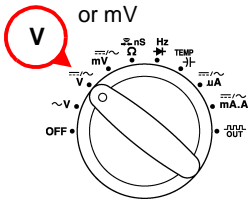

1. Set the function switch.

V : For measuring voltages above 1 V
mV : For measuring voltages below 1 V

If you are not sure of the voltage to be measured, set the function switch to "V".

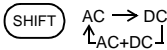

2. Use the **SHIFT** key to select either DC, AC, or AC+DC.

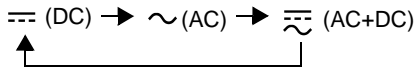

<Example>

When ACV is selected

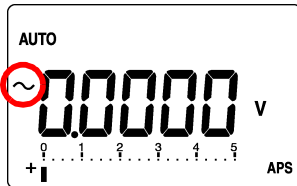

3. To set manual range, press the **RANGE** key. (Auto range is the normal setting.)
❖ (38 page)

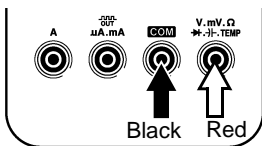

4. Connect the test leads to the test terminals.



<Example>
ACV Measurement

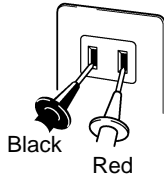

DCV Measurement

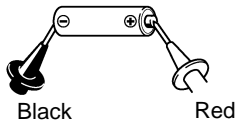

<Example>
When measuring AC voltage

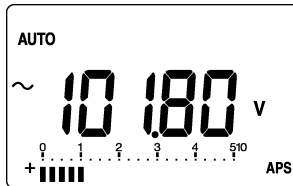

5. Connect the test leads to the object being tested.

6. Read the value displayed in the main display.

To display the frequency, press the **Hz** key or the **DUAL** key.

❖ (28 page)

To display dBm or dBV, press the **DUAL** key twice.

When using the \sim V function, the **SHIFT** key (hold down) can also be used to toggle between dBm and dBV.

❖ (59 page)

NOTE

AC voltage can also be measured by using the \sim V function.

2.3 Current Measurement



DANGER

Never apply voltage to the test leads. Doing so may damage the instrument and result in personal injury. To avoid electrical accidents, remove power from the circuit before measuring.

2

Measurement

WARNING

When a test lead is connected to terminal A, an alarm sounds if the function switch is set to a function other than mA or A. For safety, if the alarm sounds, immediately remove the test lead from the object being tested.

CAUTION

- Note that the instrument may be damaged if voltage or current the measurement range.
- When the power is turned off, do not apply voltage or current to the measurement terminal. Doing so may damage the instrument.

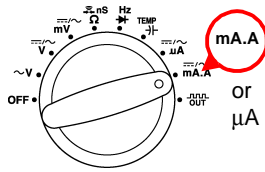

<Example>
When ACA is selected

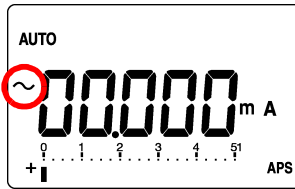

RANGE (AUTO off)

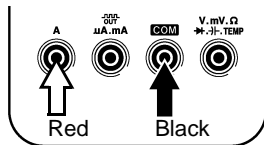

<Example>
When measuring AC current

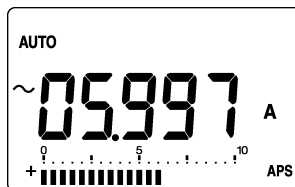

1. Set the function switch.

mA.A: For measuring voltages above 5100 μA
 μA : For measuring voltages below 5100 μA

If you are not sure of the voltage to be measured, set the function switch to "mA.A".

2. Use the **SHIFT** key to select either DC, AC, or AC+DC.

3. To set manual range, press the **RANGE** key.

(Auto range is the normal setting.)

❖ (38 page)

4. Connect the test leads to the test terminals.

For mA measurement or μA measurement, connect the red test lead to the μA .mA terminal.

5. Connect the test leads to the object being tested.

6. Read the value displayed in the main display.

To display the frequency, press the **Hz** key or the **DUAL** key.

❖ (28 page)

When using the DCmA function, press the **DUAL** key three times to switch to the percentage conversion display (4-20mA/0-20 mA). This function can be used to check industrial meters.

❖ (59 page)

2.4 Resistance Measurement



! DANGER

Never apply voltage to the test leads. Doing so may damage the instrument and result in personal injury. To avoid electrical accidents, remove power from the circuit before measuring.

2

Measurement

2.4.1 Resistance Measurement (Ω)

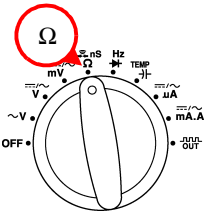

1. Set the function switch.

RANGE (AUTO off)

2. To set manual range, press the **RANGE** key.
(Auto range is the normal setting.)
❖ (38 page)

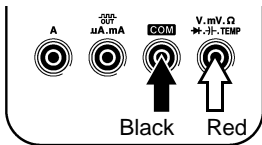

3. Connect the test leads to the test terminals.

<Example>

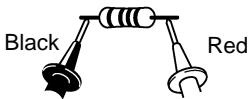

4. Connect the test leads to the object being tested.



5. Read the value displayed in the main display.

2.4.2 Conductance ($1/\Omega$) Measurement (nS)

The conductance measurement displays the reciprocal of the resistance. The display unit is "nS" (nanosiemens). For example, if the resistance is $40\text{ M}\Omega$, the conductance measurement will be $1/40\text{ M}\Omega = 25\text{ nS}$. (M is 10^6 , n is 10^{-9}). If the resistance is infinity, 0 nS is displayed. This is used when the resistance is extremely large.

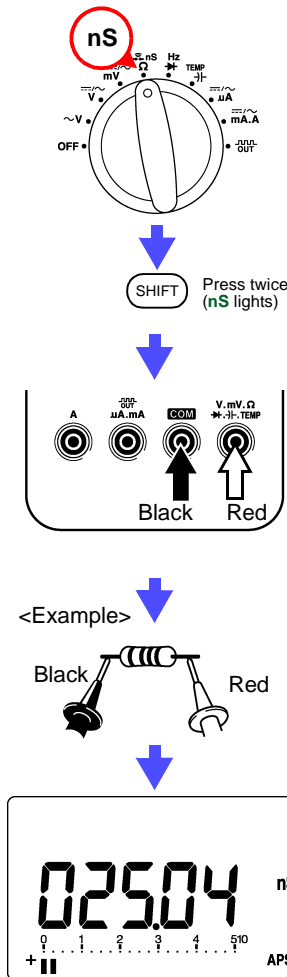

1. Set the function switch.

2. Select nS with the **SHIFT** key.

3. Connect the test leads to the test terminals.

4. Connect the test leads to the object being tested.

5. Read the value displayed in the main display.

2.5 Continuity Check



Never apply voltage to the test leads. Doing so may damage the instrument and result in personal injury. To avoid electrical accidents, remove power from the circuit before measuring.

2

Measurement

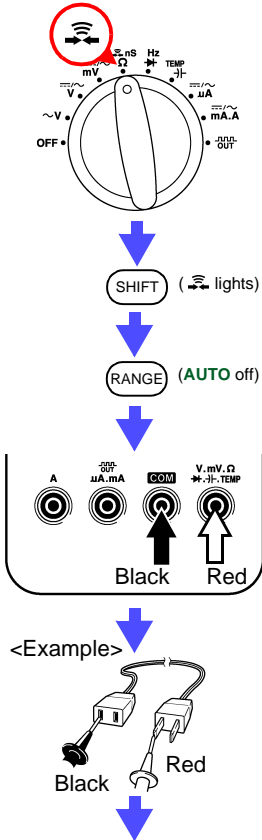

1. Set the function switch.
2. Select  with the **SHIFT** key.
3. If you want to change the range, press the **RANGE** key.
(Normally, manual range is used.)
To change to auto range, hold the **RANGE** key down.
❖ (38 page)
4. Connect the test leads to the test terminals.
5. Connect the test leads to the object being tested.
6. Read the value displayed in the main display.

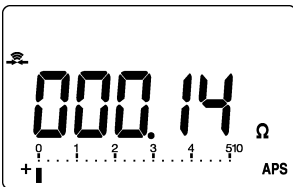

In each range, the buzzer sounds when the count is less than 1000 (less than 10.00 Ω in the 510.00 Ω range).
However, in relative value display mode, this conforms with the internally measured value, not the display value.

2.6 Diode Check



Never apply voltage to the test leads. Doing so may damage the instrument and result in personal injury. To avoid electrical accidents, remove power from the circuit before measuring.

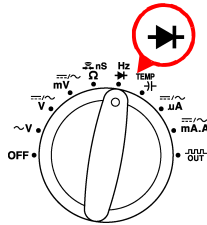

1. Set the function switch.

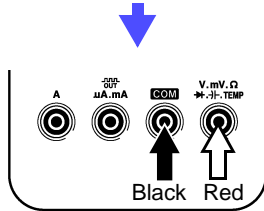

2. Connect the test leads to the test terminals.

<Example>

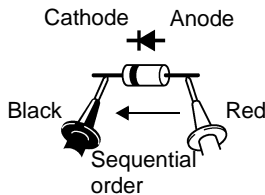

3. Connect the test leads to the object being tested.

4. Read the value displayed in the main display.



With a normal diode, the sequential order voltage (0.3 to 0.8 V) is displayed. When the display value less than 0.0500 V, buzzer sounds. When the display value drops to the range of 0.3 to 0.8 V, a single buzzer sounds to indicate that a diode was detected. However, in relative value display mode, this conforms with the internally measured value, not the display value.

2.7 Capacitance Measurement



! DANGER

Never apply voltage to the test leads. Doing so may damage the instrument and result in personal injury. To avoid electrical accidents, remove power from the circuit before measuring.

2

Measurement

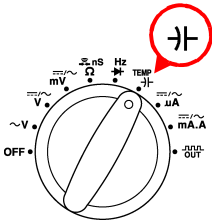

1. Set the function switch.

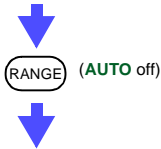

2. If you want to change the range, press the **RANGE** key.
(Normally, manual range is used.)
❖ (38 page)

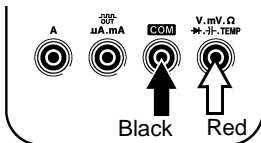

3. Connect the test leads to the test terminals.

<Example>

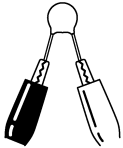

4. Connect the test leads to the object being tested.

5. Read the value displayed in the main display.

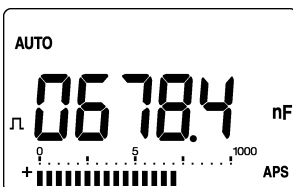

The sample rate for the 99.99 mF range is 0.01 times/second. It may take as long as two minutes before the measured value is displayed.

This instrument measures capacitance by the charge-discharge method. $\square\square\square$ on the display indicates that the capacitor is charging ($\square\square$) / discharging (\square).

2.8 Frequency Measurement



CAUTION

- Note that the instrument may be damaged if voltage or current the measurement range.
- When the power is turned off, do not apply voltage or current to the measurement terminal. Doing so may damage the instrument.
- Note that zero is displayed if a frequency signal that exceeds the frequency measurement range is measured.

2.8.1 Frequency Measurement

In order to display the frequency while measuring voltage or current, press the **Hz** key or the **DUAL** key.

- ❖ See Section 2.2 Voltage Measurement (page 19)
- ❖ See Section 2.3 Current Measurement (page 21)
- ❖ Setting method of minimum frequency:
See Chapter 4 Power On Options (page 51)

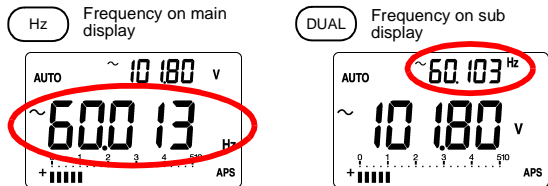

Pressing the **RANGE** key changes the parameter range on the main display.

NOTE

The bar graph conforms with voltage measurement or current measurement.

2.8.2 Frequency Counter Measurement

Use for measurement of high frequencies, such as a CPU clock signal.

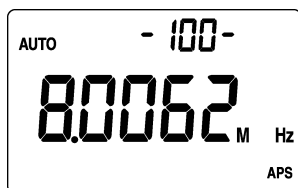
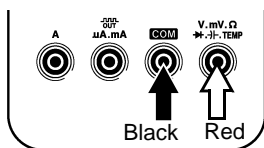
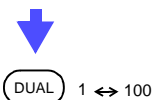
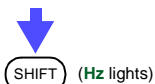
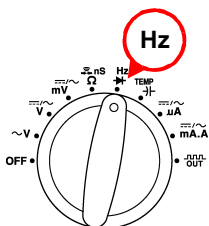

1. Set the function switch.
2. Select Hz counter with the **SHIFT** key.
3. Select the division with the **DUAL** key. (Pressing the **DUAL** key toggles between 1 and 100.)
4. If you want to change the range, press the **RANGE** key. (Normally, manual range is used.)
❖ (38 page)
5. Connect the test leads to the test terminals.
6. Connect the test leads to the object being tested.
7. Use the **Hz** key to change the DUTY ratio, pulse width, and frequency. (Duty ratio and pulse width cannot be measured at 100 cycles)
8. Read the value displayed in the main display.

2

Measurement

2.9 DUTY Ratio Measurement



The duty ratio is the ratio between the pulse width and the pulse cycle. This instrument displays this ratio in terms of 100 (%).

Plus slope pulse width Minus slope pulse width

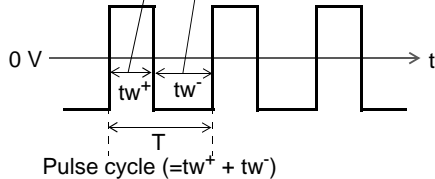

Plus slope \sqcup duty ratio (D+): $D+ = tw^+/T \times 100$ (%)

Minus slope \sqcap duty ratio (D-): $D- = tw^-/T \times 100$ (%)

1. Set the function switch.
 - ❖ See Section 2.2 Voltage Measurement (page 19)
 - ❖ See Section 2.3 Current Measurement (page 21)
 - ❖ See Section 2.8.2 Frequency Counter Measurement (page 29)
2. Use the **SHIFT** key to select either DC, AC, or AC+DC. Otherwise, select the Hz counter (one cycle).
3. Use the **Hz** key to select the DUTY ratio.
4. Connect the test leads to the test terminals.
5. Read the value displayed in the main display.

SHIFT AC → DC
↑ AC+DC ↓

Hz (% lights)

<Example>
When measuring AC voltage



To switch the pulse slope polarity \sqcup \sqcap , hold down the **SHIFT** key.

Duty ratio cannot be measured if the Hz counter (100 cycles) is selected.

NOTE

The bar graph conforms with voltage measurement or current measurement.

2.10 Pulse Width Measurement



2

Measurement

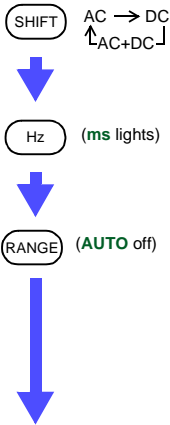

<Example>

When measuring AC voltage

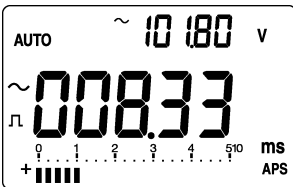

1. Set the function switch.
 - ❖ See Section 2.2 Voltage Measurement (page 19)
 - ❖ See Section 2.3 Current Measurement (page 21)
 - ❖ See Section 2.8.2 Frequency Counter Measurement (page 29)
2. Use the **SHIFT** key to select either DC, AC, or AC+DC. Otherwise, select the Hz counter (one cycle).
3. Use the **Hz** key to select the Pulse width.
4. If you want to change the range, press the **RANGE** key. (Normally, manual range is used.)
 - ❖ (38 page)
5. Connect the test leads to the test terminals.
6. Read the value displayed in the main display.

To switch the pulse slope polarity $\sqcup \sqcap \sqcap \sqcup$, hold down the **SHIFT** key.

Duty ratio cannot be measured if the Hz counter (100 cycles) is selected.

NOTE

The bar graph conforms with voltage measurement or current measurement.

2.11 Temperature Measurement



! DANGER

Never apply voltage to the test leads. Doing so may damage the instrument and result in personal injury. To avoid electrical accidents, remove power from the circuit before measuring.

! CAUTION

- The sensor used in the temperature probe is a thin, precision platinum film. Be aware that excessive voltage pulses or static discharges can destroy the film.
- Avoid subjecting the temperature probe tip to physical shock, and avoid sharp bends in the leads. These may damage the probe or break a wire.
- When measuring high temperatures, do not let the handle of the temperature probe or the compensation lead wire exceed the temperature range.

NOTE

- Clean the surface of the object to be measured, and then touch the temperature probe firmly to the surface.
- If a temperature greater than the ambient temperature is to be measured, move the temperature probe along the surface of the object being measured until the maximum reading is obtained.
- If a temperature below the ambient temperature is to be measured, move the temperature probe along the surface of the object being measured until the minimum reading is obtained.
- The sub display shows the environmental temperature according to the internal temperature sensor.

2.11 Temperature Measurement

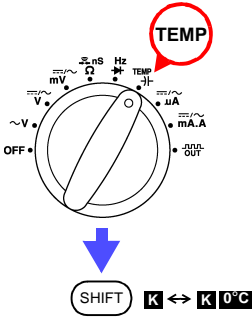

<Example> K (J) is selected

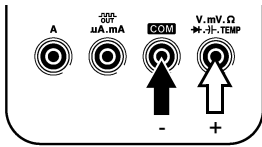

<Example>

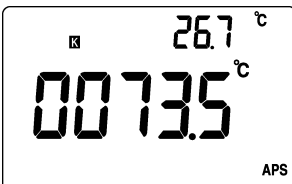
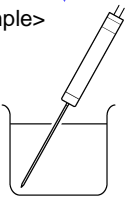

1. Select the thermocouple sensor (K or J).

❖ See Section 4.6 Thermocouple Type Setting (page 60)

2. Set the function switch.

3. Use the **SHIFT** key to select the temperature display.

K (J): Uses reference contact temperature compensation according to the instrument's internal temperature sensor

K (J) 0°C: No reference contact temperature compensation (0°C reference)

4. Connect the temperature probe to the test terminals.

5. Connect the temperature probe to the object being tested.

6. Read the value displayed in the main display.

2

Measurement

2.12 Pulse Output Function



The pulse output function can be used as a signal source for checking a variety of pulse signal equipment. The amplitude is fixed to 0 to 2.8 V, while the frequency and duty ratio (or pulse width) can be varied.

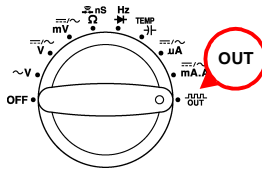

1. Set the function switch.



HOLD or **REL** key

2. Press the **HOLD** key, the **REL** key or the **Hz** key to set the frequency in the main display.

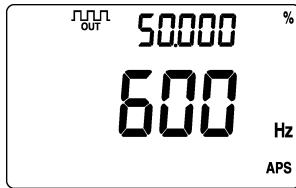

SHIFT

3. Press the **SHIFT** key to select either the pulse width or the duty ratio for the sub display.



RANGE or **DUAL** key

4. Press the **RANGE** key or the **DUAL** key to set the duty ratio (pulse width) in the sub display screen.

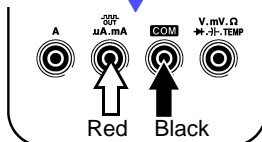
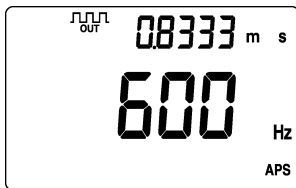

5. Connect the test leads to the test terminals.

6. Connect the test lead to the output target.

NOTE

- As soon as the function switch is set to pulse output, the pulse voltage is output from the output terminal.
- The initial settings are a frequency of 600 Hz and a duty ratio of 50.00%. Turning off the instrument restores these initial settings.

Pulse Output

Setting	Range	Resolution	Accuracy
Frequency	0.5, 1, 2, 5, 10, 15, 20, 25, 30, 40, 50, 60, 75, 80, 100, 120, 150, 200, 240, 300, 400, 480, 600, 800, 1200, 1600, 2400, 4800 Hz	0.01 Hz	± 0.005%rdg. ± 2 dgt.
DUTY ratio	0.39% to 99.60%	0.390625%	± 0.4%
Pulse width	1/ Frequency	Range/ 256	± 0.01%rdg. ± 0.3 ms
Amplitude	Fixed, 2.8 V		± 0.2 V

Output impedance: 3.5 kΩ or less

Additional Functions

3

3.1 Auto Range Function

The auto range function automatically selects the optimal range for measurement. Use this function when you do not know the strength of the input signal or if you wish to avoid having to set the range manually.

Auto range is set automatically as soon as the power is turned on in all functions, except for the continuity check function. ("AUTO" lights on the screen.)

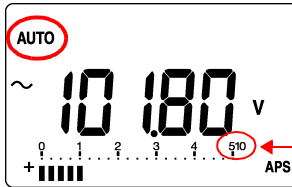

Current range
(This screen indicates a
510 V range.)

3

Additional Functions

Threshold Values

Range	Up	Down	Full Scale
51000 counts	Exceeds 51000	Below 4500	51000
10000 counts	--	Below 4500	15000
10.000 A counts	--	Below 4.500	51.000 A
9999 counts	Exceeds 11000	Below 900	11000
99999 counts	Exceeds 99999	Below 9000	99999

NOTE

- When using the continuity check function, manual range is the initial setting.
- Auto range is not available for nS measurement, diode check, temperature measurement, and DUTY ratio measurement.

3.2 Manual Range Function

Press the **RANGE** key to set the manual range function. Each time the key is pressed the range increases, and the position of the decimal point changes. Use this function when you know the strength of the input signal. To change to auto range, hold down the **RANGE** key.

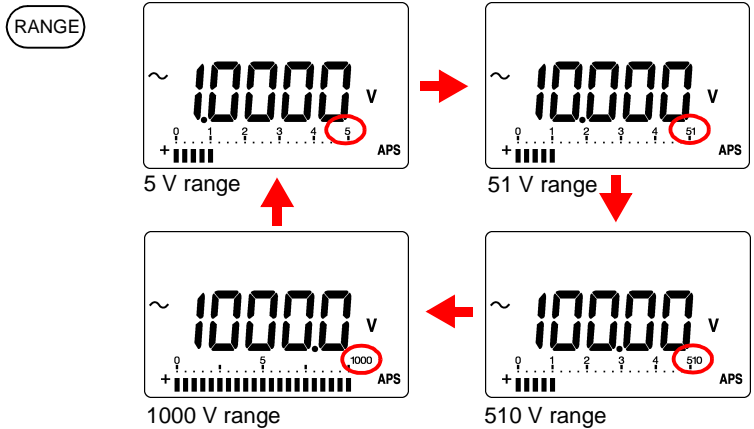

NOTE

- When using the continuity check function, manual range is the initial setting. When using except for the continuity check function, Auto range is the initial setting.
- Auto range is not available for nS measurement, diode check, temperature measurement, and DUTY ratio measurement.

3.3 Hold Functions

3.3.1 Trigger Hold Function

The trigger hold function locks the value that was being measured at the moment that the **HOLD** key was pressed.

1. Turn the refresh hold function off.
❖ See Section 4.8 Refresh Hold Setting (page 62)
2. Press the **HOLD** key during measurement to lock the displayed value.

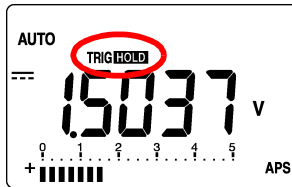

3. To update and lock the displayed value again, press the **HOLD** key again.

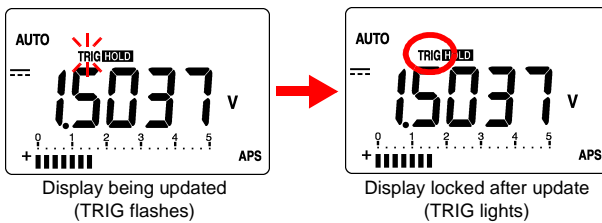

To cancel the trigger hold function, press and hold the **HOLD** key.

3

Additional Functions

3.3.2 Refresh Hold Function

The refresh hold function locks the display value automatically once the measurement value stabilizes. As the display value remains locked even if you remove the test leads from the test subject, this function is useful when you are measuring in locations where it is difficult to see the display value or when you are using both hands to take measurements.

1. Set the refresh hold threshold value (the amount of change once the display has stabilized).
❖ Setting method of threshold value:
See Section 4.8 Refresh Hold Setting (page 62)
2. Press the **HOLD** key to set the instrument to wait for the trigger.
3. Connect the test lead to the test subject. Once the display value stabilizes, "**HOLD**" lights, a buzzer sounds and the display is locked.

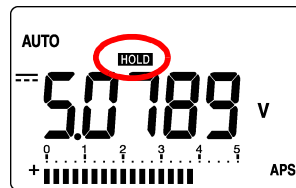

4. After confirming that the buzzer has sounded, remove the test lead from the test subject. The display value remains locked, "**HOLD**" flashes and the instrument waits for the next trigger. To cancel refresh hold mode, hold down the **HOLD** key.

NOTE

If the display value does not exceed the threshold value that was set, the display value is not locked in. If you have trouble getting the display value to lock, try changing the threshold value.

* The threshold value of each function is shown below.

Function	Threshold value
V	0.05 V
mV	0.5 mV
μ A	5 μ A
mA	0.5 mA
A	0.05 A
Ω	OL

3

Additional Functions

The refresh hold function locks the display if the display value exceeds the threshold value and the internal measurement value stabilizes to a value within the set range of threshold values.

The display is updated and locked each time the internal measurement value exceeds the range of threshold values for the locked display value.

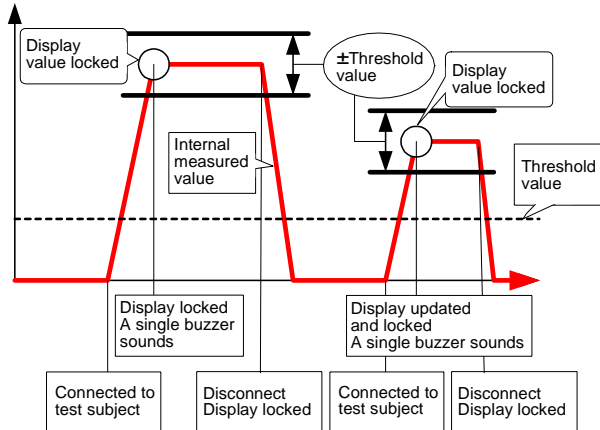

3.3.3 Peak Hold Function

This function locks in the maximum and minimum change in the measured value of an input signal over a period of 1ms (one-shot) or 250 μ s (repetitive).

Input signal maximum value : **HOLD** **MAX**

Input signal minimum value : **HOLD** **MIN**

1. To turn on the PEAK HOLD function, hold down the **REL** key while measurement is in progress. The maximum value for the input signal is displayed in the main display.

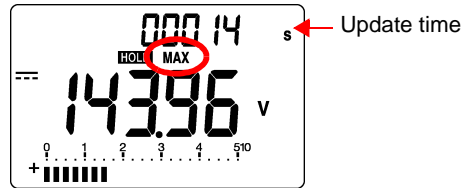

The display is updated and the buzzer sounds if the maximum (or minimum) value that is displayed is exceeded.

2. Press the **HOLD** key to display the minimum value for the input signal. Pressing the **HOLD** key repeatedly toggles the displayed value between the minimum and maximum value.



3. To clear the maximum value, minimum value and update time and restart, press the **DUAL** key. To cancel the peak hold function, hold down the **REL** key.

NOTE

- The range is locked in the peak hold function. Press the **RANGE** key to select the range. Changing the range restarts the function.
- The sub display shows the time from the start of the peak hold function until the maximum (minimum) value was updated. The maximum elapsed time that can be displayed is 99999 seconds; if this time is exceeded, "OL" is displayed.
- The auto power save function is disabled automatically when you use the peak hold function.
- Only DC function accuracy is specified for the peak hold function.

3

Additional Functions

3.4 Recording Function

This function records the maximum, minimum and average value of the input signal starting from the time when the recording function was started.

Input signal current value : **MAX MIN AVG**

Input signal maximum value : **MAX**

Input signal minimum value : **MIN**

Input signal average value : **AVG**

1. To turn on the recording function, hold down the **HOLD** key while measurement is in progress.

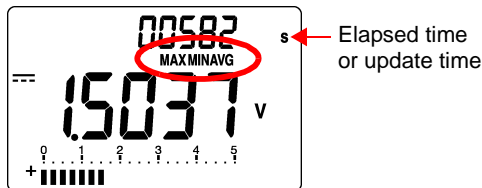

3.4 Recording Function

2. Press the **HOLD** key again to toggle between the maximum value, minimum value, average value, current value and the main display.

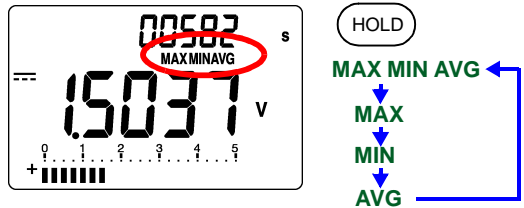

When the maximum value (or minimum value) is updated, the buzzer sounds.

3. To clear the maximum value, minimum value average value and time and restart, press the **DUAL** key. To cancel the recording function, hold down the **HOLD** key.

NOTE

- The sub display shows the elapsed time (current value, average value) from the start of the recording function, or the update time (maximum value, minimum value). The maximum elapsed time that can be displayed is 99999 seconds; if this time is exceeded, "OL" is displayed.
- The recording function records the maximum value, minimum value, and average value of the internal measurement data prior to smoothing, not the displayed values.
- The auto power save function is disabled automatically when you use the recording function.

3.5 Relative (REL) Display Function

Pressing the **REL** key causes future values to be displayed relative to the currently displayed value, which becomes the reference value.

To reproduce a zero adjust function while measuring voltage (mV), resistance, etc., short the test leads to set the relative value display mode. (This cancels the Seebeck effect and the effect of wiring resistance.)

1. Display the measured value that you want to set as the reference value.

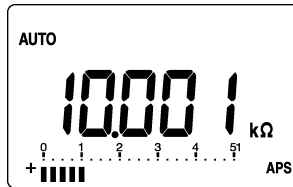

2. Pressing the **REL** key sets the currently displayed value as the reference value, and displays future values as relative values to that reference value.

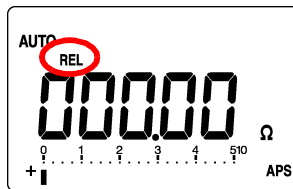

NOTE

The bar graph conforms with the displayed relative.

3

Additional Functions

3.6 Battery Indicator Function

Holding down the \bigcirc key causes the current battery level to be displayed. The original display returns automatically after three seconds.

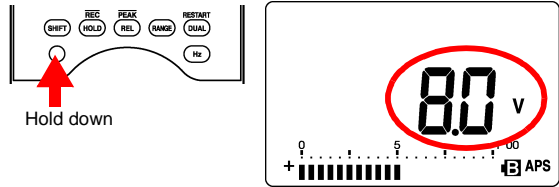

The bar graph displays a reading from 0 to 100% for the battery voltage over a range from 6.0 to 10.0 V. When it is time to replace the battery (6.0 V or less), the battery mark (B) appears on the measurement screen. When this happens, replace the battery.

❖ See Section 6.3 Replacing the Battery (page 81)

3.7 Communications Function

This instrument is equipped with an RS-232C interface-based data transmission function. If this instrument is connected to a personal computer, measurement data can be transferred from this instrument to the computer where it can be recorded and saved.

NOTE

In order to use this function, one of the following options is required. Purchase the option that is appropriate for your computer.

- When connecting to a serial port (D-sub 9-pin connector) on the computer side
3856-01 COMMUNICATION PACKAGE (RS-232C)
 - When connecting to a USB port on the computer side
3856-02 COMMUNICATION PACKAGE (USB)
- ❖ Model 3856-01 or Model 3856-02 Instruction Manual

1. Install the software in the personal computer.
❖ Model 3856-01 or Model 3856-02 Instruction Manual
2. Set up the personal computer and the 3801-50 for communications.
❖ See Section 4.1 Communications Settings (page 53)

When the software of the communications package is used, set up the instrument as follows.

Baud Rate	9600
Parity Check	None
Data Length	8 bit
Response	OFF
Data Output	OFF

3. When using the 3856-02 communications package, install the driver in the personal computer.

3

Additional Functions

4. Connect the optical connector of the communications cable to the connector on the holster for the 3801-50.

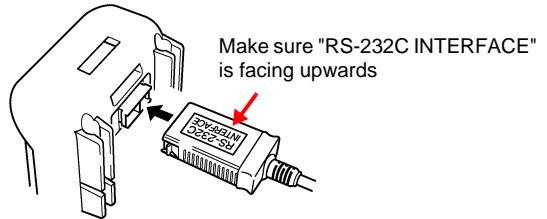

Communication is not possible if "RS-232C INTERFACE" is facing downwards.

5. Connect the other end of the communications cable to the personal computer.
6. Start the software. The measurement data is transferred from the 3801-50 to the personal computer.

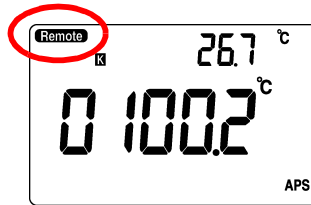

NOTE

To disconnect the connector from the 3801-50, squeeze the clips while pulling the connector out.

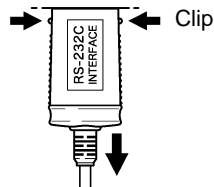

3.8 Warning Functions

3.8.1 Terminal A Misconnection Warning



When a test lead is connected to terminal A, an alarm sounds if the function switch is set to a function other than mA or A. For safety, if the alarm sounds, immediately remove the test lead from the object being tested.

3

Additional Functions

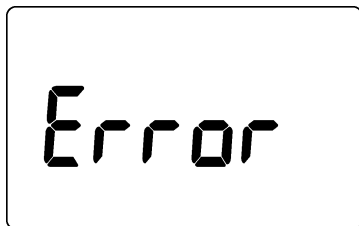

3.8.2 Overload Warning

During voltage measurement, if the input voltage exceeds 1010.0 V, the 3801-50 sounds an intermittent beep as a warning. Remove the test leads from the test subject immediately.

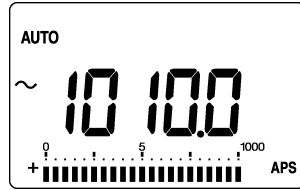

NOTE

If full scale is exceeded in any of the ranges, "OL" is displayed. Either set auto range or else select the correct range.

❖ See Section 3.1 Auto Range Function (page 37) and Section 3.2 Manual Range Function (page 38)

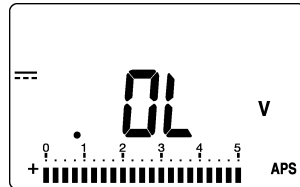

Range	Full Scale
51000 counts	51000
10000 counts	15000
10.000 A counts	51.000 A
9999 counts	11000
99999 counts	99999

Power On Options

4

The Power On Option Setting screen is used to set the following items.

Power On Option	Description	Ref Page
Baud Rate	Sets the communications speed. (communications setting)	(53 page)
Parity Check	Sets parity checking. (communications setting)	(53 page)
Data Length	Sets the data length. (communications setting)	(54 page)
Response	Turns response ON/OFF. (communications setting)	(54 page)
Data Output	Turns data output ON/OFF. (communications setting)	(55 page)
Percentage Display	Toggles the percentage display between 4 - 20mA and 0 - 20mA.	(56 page)
Minimum Frequency	Sets the minimum frequency.	(57 page)
Buzzer Sound	Sets the buzzer sound.	(58 page)
Decibel Display	Toggles between dBm and dBV.	(59 page)
Thermocouple Type	Selects the thermocouple type.	(60 page)
Temperature Display	Selects the temperature display.	(61 page)
Refresh Hold	Sets the refresh hold function.	(62 page)
Auto Power Save	Sets the time until the auto power save function is activated.	(63 page)
Display Backlight	Sets the time until the display backlight turns off automatically.	(64 page)
Reference Impedance	Sets the reference impedance.	(65 page)
Reset	Resets this instrument.	(66 page)

4

Power On Options

Power On Option Setting Screen List

SHIFT+Power On

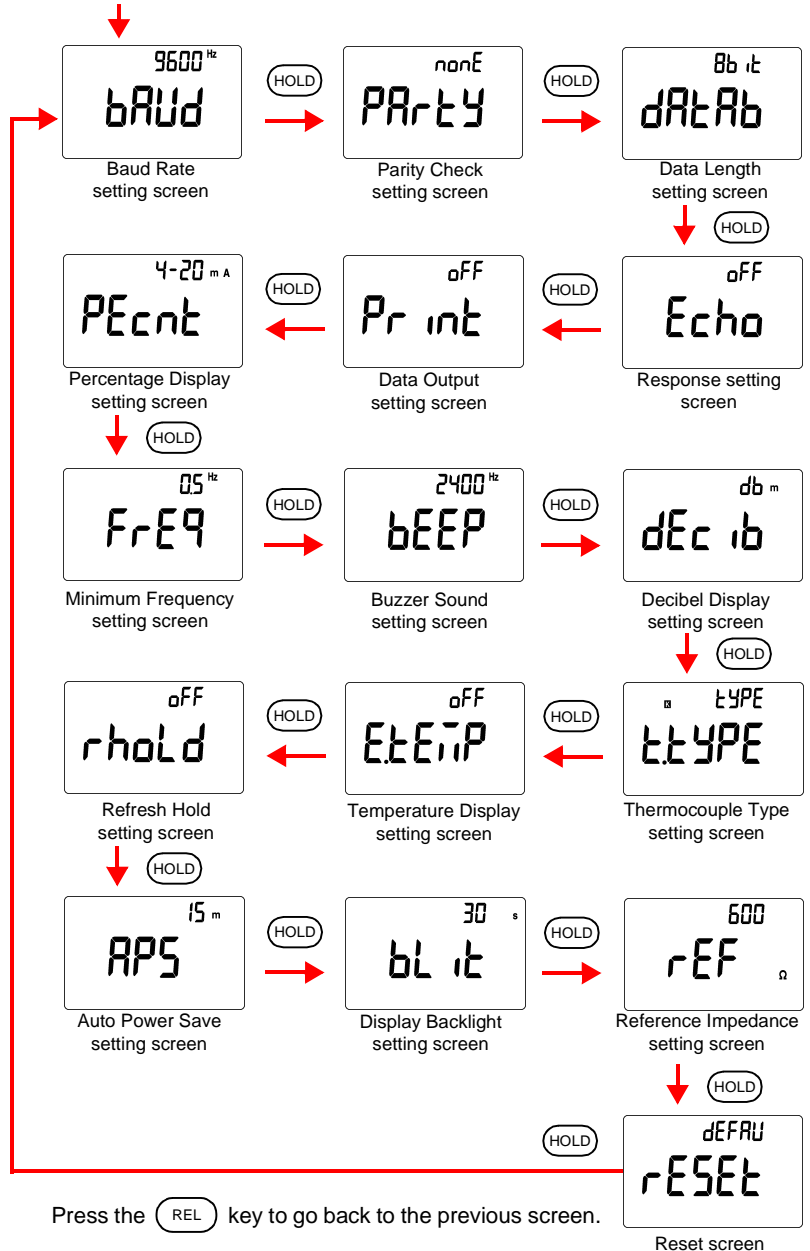

4.1 Communications Settings

4.1.1 Communications Speed Setting (Baud Rate)

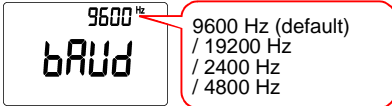
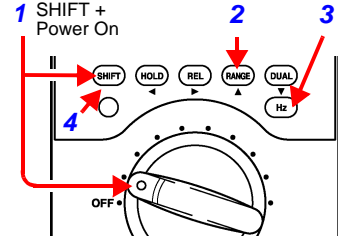

1. In order to display the Baud Rate setting screen, hold down the **SHIFT** key while turning the function switch.
2. Press the **RANGE** key or the **DUAL** key to select the communications speed.
3. Confirm the selection by pressing the **Hz** key.
4. Hold down the **SHIFT** key to enter the measurement screen.

Otherwise, turn the function switch to OFF to finish setup.

4

Power On Options

4.1.2 Parity Check Setting

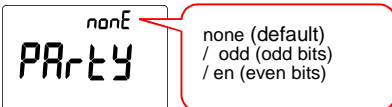
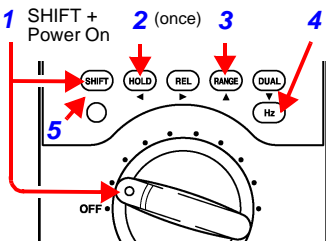

1. In order to display the Power On Option setting screen, hold down the **SHIFT** key while turning the function switch.
2. Press the **HOLD** key once to display the Parity Check setting screen.
3. Press the **RANGE** key or the **DUAL** key to select the parity check.
4. Confirm the selection by pressing the **Hz** key.
5. Hold down the **SHIFT** key to enter the measurement screen.

Otherwise, turn the function switch to OFF to finish setup.

4.1.3 Data Length Setting

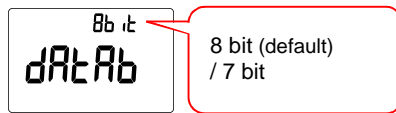
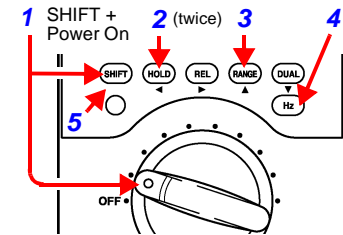

1. In order to display the Power On Option setting screen, hold down the **SHIFT** key while turning the function switch.
2. Press the **HOLD** key twice to display the Data Length setting screen.
3. Press the **RANGE** key or the **DUAL** key to select the data length.
4. Confirm the selection by pressing the **Hz** key.
5. Hold down the **SHIFT** key to enter the measurement screen.

Otherwise, turn the function switch to OFF to finish setup.

4.1.4 Response ON/OFF Setting

If response is turned on, this instrument returns all of the characters received.

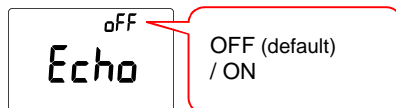
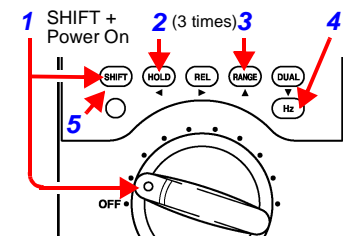

1. In order to display the Power On Option setting screen, hold down the **SHIFT** key while turning the function switch.
2. Press the **HOLD** key 3 times to display the Response setting screen.
3. Press the **RANGE** key or the **DUAL** key to select the response setting.
4. Confirm the selection by pressing the **Hz** key.
5. Hold down the **SHIFT** key to enter the measurement screen.

Otherwise, turn the function switch to OFF to finish setup.

4.1.5 Data Output ON/OFF Setting

If data output is on, this instrument only outputs data after each sample. It does not receive commands.

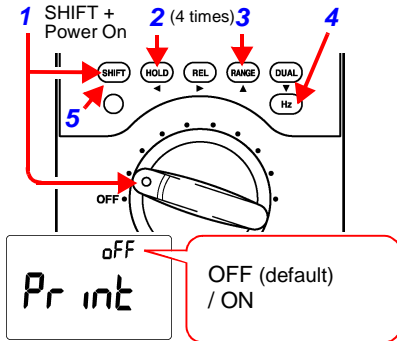

1. In order to display the Power On Option setting screen, hold down the **SHIFT** key while turning the function switch.
 2. Press the **HOLD** key 4 times to display the Data Output setting screen.
 3. Press the **RANGE** key or the **DUAL** key to select the data output setting.
 4. Confirm the selection by pressing the **Hz** key.
 5. Hold down the **SHIFT** key to enter the measurement screen.
- Otherwise, turn the function switch to OFF to finish setup.

4

Power On Options

4.2 Toggling the Percentage Display (4 - 20mA/0 - 20mA)

When measuring with the DCmA function, press the **DUAL** key three times to display the percentage display in the sub display.

This procedure sets the percentage display method.

4-20 mA	Converts the current over a range of 4 mA to 20 mA into a percentage from 0 to 100%.
0-20 mA	Converts the current over a range of 0 mA to 20 mA into a percentage from 0 to 100%.

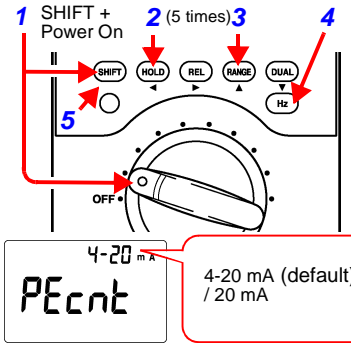

1. In order to display the Power On Option setting screen, hold down the **SHIFT** key while turning the function switch.
2. Press the **HOLD** key 5 times to display the Percentage Display setting screen.
3. Press the **RANGE** key or the **DUAL** key to select the percentage display setting.
4. Confirm the selection by pressing the **Hz** key.
5. Hold down the **SHIFT** key to enter the measurement screen.

Otherwise, turn the function switch to OFF to finish setup.

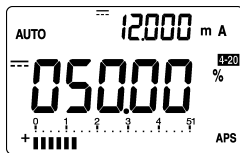

$$\text{Percentage conversion value} = \frac{\text{Measured value[mA]} - 4[\text{mA}]}{16[\text{mA}]} \times 100[\%]$$

↑ Select through power on option



$$\text{Percentage conversion value} = \frac{\text{Measured value[mA]}}{20[\text{mA}]} \times 100[\%]$$

4.3 Minimum Frequency Setting

Sets the minimum frequency for frequency and frequency counter measurement. The setting of the minimum frequency determines the sampling time (gate time) used in low frequency measurement.

<Example>

Minimum frequency 0.5 Hz → Sampling time 2 s

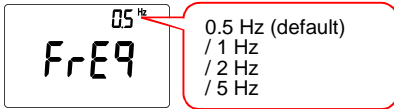
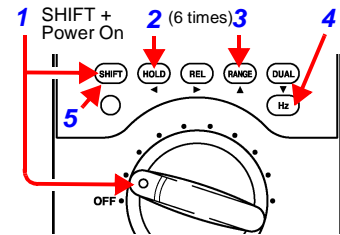

1. In order to display the Power On Option setting screen, hold down the **SHIFT** key while turning the function switch.
2. Press the **HOLD** key 6 times to display the Minimum Frequency setting screen.
3. Press the **RANGE** key or the **DUAL** key to select the minimum frequency setting.
4. Confirm the selection by pressing the **Hz** key.
5. Hold down the **SHIFT** key to enter the measurement screen.

4

Power On Options

Otherwise, turn the function switch to OFF to finish setup.

4.4 Buzzer Sound setting

The buzzer sound can be set as preferred.

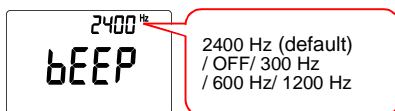
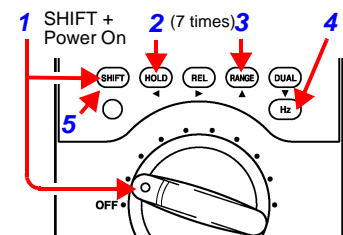

1. In order to display the Power On Option setting screen, hold down the **SHIFT** key while turning the function switch.
2. Press the **HOLD** key 7 times to display the Buzzer Sound setting screen.
3. Press the **RANGE** key or the **DUAL** key to select the buzzer sound setting.
4. Confirm the selection by pressing the **Hz** key.
5. Hold down the **SHIFT** key to enter the measurement screen.

Otherwise, turn the function switch to OFF to finish setup.

4.5 Toggling the Decibel Display (dBm/ dBV)

While measuring voltage, pressing the **DUAL** key twice displays the measured value converted into decibels in the sub display. The procedure for setting this display method is described below.

dBm	During voltage measurement, converts into decibels the ratio of power versus power of 1 mW for the reference resistance.
dBV	During voltage measurement, converts into decibels the ratio of voltage versus the reference voltage of 1 V.

4

Power On Options

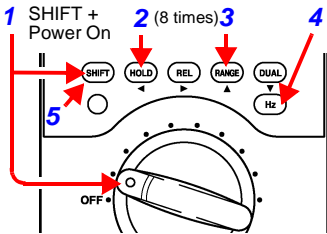

1. In order to display the Power On Option setting screen, hold down the **SHIFT** key while turning the function switch.
2. Press the **HOLD** key 8 times to display the Decibel Display setting screen.
3. Press the **RANGE** key or the **DUAL** key to select the decibel display setting.
4. Confirm the selection by pressing the **Hz** key.
5. Hold down the **SHIFT** key to enter the measurement screen.



Otherwise, turn the function switch to OFF to finish setup.

4.6 Thermocouple Type Setting

<Display example> 600 Ω

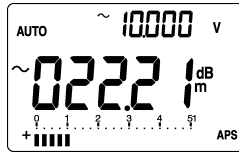

$$\text{dBm} = 10 \log_{10} \frac{(\text{Measured value [V]})^2 \times 1000}{\text{Reference resistance } [\Omega]} \text{ [dBm]}$$

↑ Select through
power on option

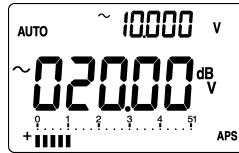

$$\text{dBV} = 20 \log_{10} (\text{Measured value[V]}) \text{ [dBV]}$$

❖ Setting Method of reference resistance:

See Section 4.11 Reference Impedance Setting (page 65)

4.6 Thermocouple Type Setting

Set according to the type of thermocouple in the temperature probe to be used.

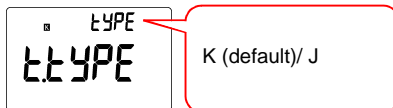
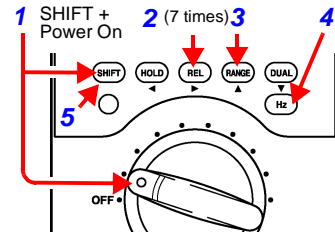

1. In order to display the Power On Option setting screen, hold down the **SHIFT** key while turning the function switch.
2. Press the **REL** key 7 times to display the Thermocouple Type setting screen.
3. Press the **RANGE** key or the **DUAL** key to select the thermocouple type setting.
4. Confirm the selection by pressing the **Hz** key.
5. Hold down the **SHIFT** key to enter the measurement screen.

Otherwise, turn the function switch to OFF to finish setup.

4.7 Temperature Display Setting

Set whether to display the ambient temperature or not in the sub display. (The ambient temperature is measured by a temperature sensor in the instrument.)

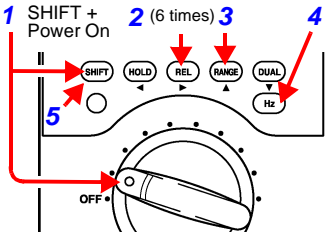

1. In order to display the Power On Option setting screen, hold down the **SHIFT** key while turning the function switch.
2. Press the **REL** key 6 times to display the Temperature Display setting screen.
3. Press the **RANGE** key or the **DUAL** key to select the temperature display setting.
4. Confirm the selection by pressing the **Hz** key.
5. Hold down the **SHIFT** key to enter the measurement screen.

4

Power On Options

Otherwise, turn the function switch to OFF to finish setup.

4.8 Refresh Hold Setting

This procedure sets the threshold value for the refresh hold function. The threshold value locks the display to showing the amount of change after the display value has stabilized, using the set amount of change as a criteria. Setting this to off disables the refresh hold function and enables the trigger hold function.

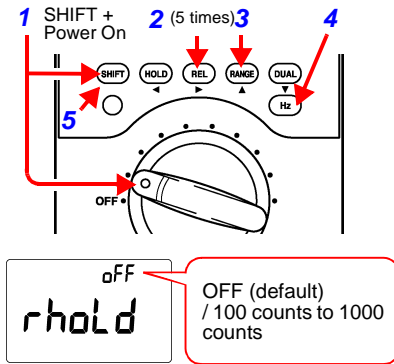

1. In order to display the Power On Option setting screen, hold down the **SHIFT** key while turning the function switch.
2. Press the **REL** key 5 times to display the Refresh Hold setting screen.
3. Set the Refresh Hold function.
RANGE key: Increases the value
DUAL key: Decreases the value
4. Confirm the selection by pressing the **Hz** key.
5. Hold down the **SHIFT** key to enter the measurement screen.

Otherwise, turn the function switch to OFF to finish setup.

4.9 Auto Power Save Function

This procedure sets the time until the auto power save function is activated. The auto power save function is activated after the set time elapses since the last time the rotary switch or a key was operated. The auto power save function turns off the display screen and minimizes the instrument's internal power consumption.

NOTE

- In order to resume operation from the auto power save function, either turn the rotary switch to OFF and turn the power back on again or else press any key. In the case of pulse output, press any of the **HOLD**, **REL**, **RANGE** or **DUAL** keys or set the function switch to a position other than pulse output and then back to its original position. The 3801-50 reverts to the power ON state.
- The auto power save function is automatically disabled when either the peak hold function or the recording function is used.
- To disable the auto power save function, hold down the **○** key while turning the function switch to turn on the instrument.

4

Power On Options

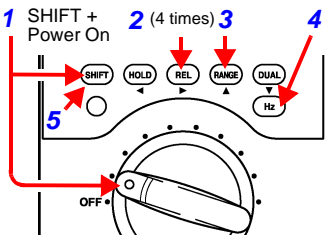
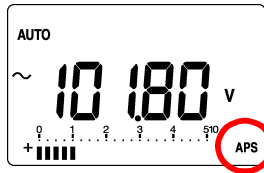

1. In order to display the Power On Option setting screen, hold down the **SHIFT** key while turning the function switch.
2. Press the **REL** key 4 times to display the Auto Power Save setting screen.
3. Set the Auto Power Save function.
 - RANGE** key: Increases the value
 - DUAL** key: Decreases the value
 - SHIFT** key: Selects the digit
4. Confirm the selection by pressing the **Hz** key.
5. Hold down the **SHIFT** key to enter the measurement screen. Otherwise, turn the function switch to OFF to finish setup.

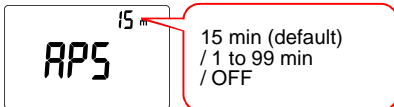

4.10 Display Backlight Setting

This procedure sets the time until the display backlight turns off. To turn on the display backlight, press the \bigcirc key. To turn off the display backlight before the time elapses, press the \bigcirc key again.

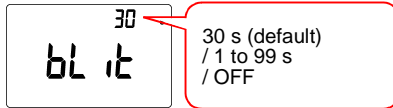
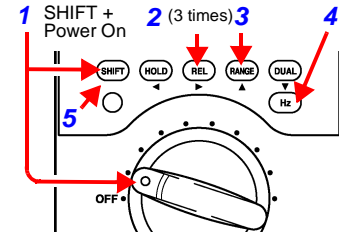

1. In order to display the Power On Option setting screen, hold down the **SHIFT** key while turning the function switch.
2. Press the **REL** key 3 times to display the Display Backlight setting screen.
3. Set the time until the display backlight turns off.
RANGE key: Increases the value
DUAL key: Decreases the value
SHIFT key: Selects the digit
4. Confirm the selection by pressing the **Hz** key.
5. Hold down the **SHIFT** key to enter the measurement screen.

Otherwise, turn the function switch to OFF to finish setup.

4.11 Reference Impedance Setting

This procedure sets the reference impedance for the decibel (dBm) conversion screen.

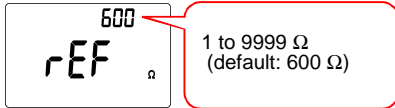
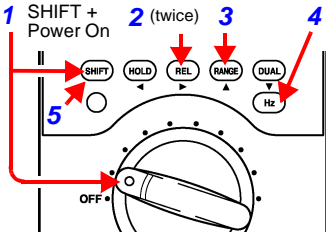

1. In order to display the Power On Option setting screen, hold down the **SHIFT** key while turning the function switch.
2. Press the **REL** key twice to display the Reference Impedance setting screen.
3. Set the reference impedance.
RANGE key: Increases the value
DUAL key: Decreases the value
SHIFT key: Selects the digit
4. Confirm the selection by pressing the **Hz** key.
5. Hold down the **SHIFT** key to enter the measurement screen.

4

Power On Options

Otherwise, turn the function switch to OFF to finish setup.

4.12 Reset

This procedure resets the power on option settings to their initial values.

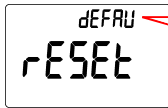
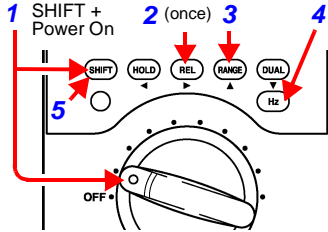

Default

1. In order to display the Power On Option setting screen, hold down the **SHIFT** key while turning the function switch.

2. Press the **REL** key once to display the Reset screen.

3. Hold down the **Hz** key to reset.

4. Hold down the **SHIFT** key to enter the measurement screen.

Otherwise, turn the function switch to OFF to finish setup.

Power On Options	Default Setting
Baud Rate	9600 bps
Parity Check	None
Data Length	8 bit
Response	OFF
Data Output	OFF
Percentage Display	4-20 mA
Minimum Frequency	0.5 Hz
Buzzer Sound	2400 Hz
Decibel Display	dBm
Thermocouple Type	K
Temperature Display	OFF
Refresh Hold	OFF
Auto Power Save	15 min
Display Backlight	30 s
Reference Impedance	600 Ω
Reset	Default

Specifications

5

5.1 General Specifications

AC measurement method	True RMS measurement
Measurement functions	<ul style="list-style-type: none"> • DC voltage measurement • AC voltage measurement • AC+DC voltage measurement • DC current measurement • AC current measurement • AC+DC current measurement • Resistance measurement • Continuity check • Diode check • Capacitance measurement • Frequency measurement • Frequency (counter) measurement • DUTY ratio measurement • Pulse width measurement • Temperature measurement
Output function	Pulse output
Additional functions	<ul style="list-style-type: none"> • Auto range function • Manual range function • Communications function (RS-232C, USB) • Refresh hold function • Trigger hold function • Peak hold function • Recording function • Percentage display (4 - 20mA/0 - 20mA) function • Decibel display (dBm/ dBV) function • Relative (REL) display function • Terminal A misconnection warning function • Display backlight function • Auto power save function • Battery indicator function • Overload warning function
Display method	TN-type LCD, 1/8 duty, dynamic drive method

5

Specifications

Display	<ul style="list-style-type: none"> Data display Main display: 4 1/2 digits Sub display: 4 1/2 digits Maximum display count [51000] Maximum display count [15000] 1000 V range/ 1000 mV range Maximum display count [99999] Hz function Maximum display count [9999] C function Polarity display [-] mark lights automatically. Over range display [OL] or [-OL] Bar graph Scale display, 21-dot bar display, ± polarity display Range count display [5] to [1000] Unit, symbol Main display: [°C][dB][%][nS][m][μ][V][A][n][F][M][k][Ω][Hz][ms] Sub display: [k][Hz][°C][%][μ][m][A][V][s][=DC][~AC][Remote] [$\frac{OUT}{IN}$][AUTO][\square][\square][\square][\square][\square][REL][TRIG] [HOLD][MAX][MIN][AVG][\square][\square][0-20][4-20] [\square][APS]
Range	Auto range or manual range
Input terminals	<ul style="list-style-type: none"> V.mV.Ω. \rightarrow. \rightarrow. TEMP COM μA.mA. $\frac{OUT}{IN}$ A
Functions	OFF, ~V, V, mV, Ω, \rightarrow , \rightarrow , μA, mA.A, $\frac{OUT}{IN}$
Key input configuration	SHIFT, HOLD, REL, RANGE, DUAL, ○ (LIGHT), Hz
Battery low warning voltage	\rightarrow mark lights when 6.0 V ± 0.2 V or less
Power supply	6F22 manganese battery or 6LR61 alkaline battery
Dimensions	Approx. 90W X 192H X 37D mm (3.54"W X 7.56"H X 1.46"D) (not including protrusion) Approx. 100W X 202H X 57D mm (3.94"W X 7.95"H X 2.24"D) (including protective holster)
Mass	Approx. 470 g (16.6 oz.) (including battery) Approx. 680 g (24.0 oz.) (including protective holster and battery)
Operating environment	Indoors, altitude up to 2000 m (6562-ft.)
Operating temperature and humidity	0°C to 50°C (32°F to 122°F), 80%RH or less (no condensation) However, when the temperature exceeds 31°C (87°F), the relative humidity reduces linearly to 50°C (122°F), 50%RH.

5.1 General Specifications

Storage temperature and humidity	-20°C to 60°C (-4°F to 140°F), 80%RH or less (no condensation)	
Warranty period	Three years (excludes measurement accuracy)	
Accessories	3851-10 TEST LEAD Strap Protective holster Instruction manual One 6LR61 alkaline battery (built into instrument)	
Replacement parts	µA.mA terminal: 440 mA fuse (1000 V AC/DC Cutoff capacity 30 kA, SIBA fast blowing fuse φ10 X 38 mm) A terminal: 11 A fuse (AC/DC 1000 V Cutoff capacity 30 kA, SIBA fast blowing fuse φ10 X 38 mm)	
Options	3853 CARRYING CASE 3856-01 COMMUNICATION PACKAGE (RS-232C) 3856-02 COMMUNICATION PACKAGE (USB) 9180 SHEATH TYPE TEMPERATURE PROBE 9181 SURFACE TEMPERATURE PROBE 9182 SHEATH TYPE TEMPERATURE PROBE 9183 SHEATH TYPE TEMPERATURE PROBE 9472 SHEATH TYPE TEMPERATURE PROBE 9473 SHEATH TYPE TEMPERATURE PROBE 9474 SHEATH TYPE TEMPERATURE PROBE 9475 SHEATH TYPE TEMPERATURE PROBE 9476 SURFACE TYPE TEMPERATURE PROBE 9617 CLIP ON BASE* 9618 CLIP-TYPE LEAD* (* not complied with the CE marking)	
Applicable Standards	Safety	EN61010-1:2001 EN61010-031:2002 Pollution degree 2, Measurement category CAT III 1000 V, CAT IV 600 V (anticipated transient overvoltage 8000 V)
	EMC	EN61326:1997+A1:1998+A2:2001 +A3:2003
Measurement accuracy	In accordance with accuracy table	
Sampling Rate	In accordance with accuracy table	
Accuracy guaranteed supply voltage range	From 10.2 V until ± 5 mark lights	
Accuracy guarantee for temperature and humidity	23°C ± 5°C (73°F ± 9°F), 80%RH (no condensation)	
Guaranteed accuracy period	For one year	

Temperature characteristic	Measurement accuracy X 0.15/ °C
Noise resistance NMR	DCV: 60 dB or more (50 Hz/ 60 Hz) ACV: 60 dB or more (DC)
Noise resistance CMRR	DCV: 90 dB or more (DC/ 50 Hz/ 60 Hz, 1 k Ω unbalance) ACV: 60 dB or more (DC/ 50 Hz/ 60 Hz, 1 k Ω unbalance)
Response time (auto range)	DCV: within 1.2 s (0 V \rightarrow 100 V auto range operation) ACV: within 2.2 s (0 V \rightarrow 100 V auto range operation) Ω : within 2.0 s (Infinite \rightarrow 0 Ω auto range operation) within 2.5 s (0 Ω \rightarrow 50 M Ω auto range operation)
Dielectric strength	6.88 kV AC for 1 minute, sin wave, between input terminals and case (50 Hz/ 60 Hz)
Maximum input voltage	V terminal: 1000 V DC/ 1000 Vrms (sin) or 10 ⁷ VHz
Maximum input current	A terminal : Continuous up to 10 A AC/DC, no more than 30 seconds up to 20 A AC/DC. μ A.mA terminal:510 mA AC/DC
Maximum rated voltage to earth	CAT III: 1000 V DC/ 1000 Vrms (sin) or 10 ⁷ VHz CAT IV: 600 V DC/ 600 Vrms (sin) or 10 ⁷ VHz
Rated supply voltage	9.0 V DC
Maximum rated power	250 mVA (Max.), supply voltage: 9.0 V DC
Rated power	60 mVA (Typ.), supply voltage: 9.0 V DC (DCV measurement) 80 mVA (Typ.), supply voltage: 9.0 V (ACV measurement)
Power during APS	0.2 mVA (Max.), supply voltage: 9.0 V
Continuous operating time	Approx. 20 hours (DCV measurement, when the manganese battery is used) Approx. 50 hours (DCV measurement, when the alkaline battery is used)

5.2 Accuracy

(Guaranteed at 23°C ± 5°C / 73°F ± 9°F, 80%RH or less)

DC mV/ V (DCV measurement)

Range	Accuracy	Input Impedance	Overload Protection
51.000 mV	± 0.05%rdg. ± 50 dgt.*	1 GΩ or more	1000 V DC/ 1000 Vrms (sin) or 10 ⁷ VHz, transient overvoltage: 8000 V Overload current: 0.3 A or less
510.00 mV			
1000.0 mV	± 0.025%rdg. ± 5 dgt.	10 MΩ	1000 V DC/ 1000 Vrms (sin) or 10 ⁷ VHz, transient overvoltage: 8000 V
5.1000 V			
51.000 V	± 0.03%rdg. ± 5 dgt.	10 MΩ	1000 V DC/ 1000 Vrms (sin) or 10 ⁷ VHz, transient overvoltage: 8000 V
510.00 V			
1000.0 V			

Sampling rate: 3.75 times/ s

* After the inputs are shorted and the relative value (REL) display function has been initiated, the accuracy is ± 0.05% rdg. ± 5 dgt.

AC mV/ V (ACV measurement)

Range	Accuracy ¹					Input Impedance
	20-45Hz	45-1kHz	1k-10kHz	10k-20kHz	20k-100kHz	
51.000 mV	± 1%rdg. ± 60 dgt.	± 0.4%rdg. ± 40 dgt.	± 0.7%rdg. ± 40 dgt.	± 1.5%rdg. ± 40 dgt.	± 3.5%rdg. ± 120 dgt.	1 GΩ or more
510.00 mV		± 0.4%rdg. ± 25 dgt.	± 0.4%rdg. ± 25 dgt.		± 3.5%rdg. ± 120 dgt.	
1000.0 mV				± 3.5%rdg. ± 120 dgt.		
5.1000 V	± 1%rdg. ± 60 dgt.	± 0.4%rdg. ± 25 dgt.	± 0.4%rdg. ± 25 dgt.	± 1.5%rdg. ± 40 dgt. ²	± 3.5%rdg. ± 120 dgt. ²	1.1 MΩ / 100 pF or less
51.000 V					± 3.5%rdg. ± 120 dgt. ²	
510.00 V				± 3.5%rdg. ± 120 dgt. ²		
1000.0 V	± 0.4%rdg. ± 40 dgt.	± 0.4%rdg. ± 40 dgt.	± 0.4%rdg. ± 40 dgt.	± 1.5%rdg. ± 40 dgt. ²	Not specified	

Sampling rate: 3.75 times/ s

Crest factor: 3 or less

Overload protection: 1000 V DC/1000 Vrms (sin) or 10⁷VHz, transient overvoltage 8000 V, Overload current 0.3 A or less (ACmV)

*1: Accuracy not specified at less than 5% of range

*2: Accuracy specified for 200 Vrms or less when exceeding 10 kHz

AC+DCmV/ V (AC+DCV measurement)

Range	Accuracy ¹					Input Impedance		
	20-45Hz	45-1kHz	1k-10kHz	10k-20kHz	20k-100kHz			
51.000 mV	±1.2%rdg. ±80 dgt.	±0.4%rdg. ± 60 dgt.	±0.7%rdg. ± 60 dgt.	±1.5%rdg. ± 60 dgt.	±3.5%rdg. ± 220 dgt.	1 GΩ or more		
510.00 mV	±1.2%rdg. ±65 dgt.	±0.4%rdg. ± 30 dgt.	±0.4%rdg. ± 30 dgt.	±1.5%rdg. ± 45 dgt.	±3.5%rdg. ± 125 dgt.			
1000.0 mV								
5.1000 V	±1.2%rdg. ±65 dgt.	±0.4%rdg. ± 30 dgt.	±0.4%rdg. ± 30 dgt.	±1.5%rdg. ± 45 dgt. ²	±3.5%rdg. ± 125 dgt.	1.1 MΩ/ 100 pF or less		
51.000 V								
510.00 V				±0.4%rdg. ± 45 dgt.	±0.4%rdg. ± 45 dgt.		±1.5%rdg. ± 45 dgt. ²	±3.5%rdg. ± 125 dgt. ²
1000.0 V								

Sampling rate: 1.65 times /s

Crest factor: 3 or less

Overload protection: 1000 V DC/ 1000 Vrms (sin) or 10⁷ VHz, transient overvoltage 8000 V, Overload current 0.3 A or less (AC+DCmV)

*1: Accuracy not specified at less than 5% of range (An accuracy of 45 Hz to 1 kHz is applicable only for a DC component)

*2: Accuracy specified for 200 Vrms or less when exceeding 10 kHz

dB (Decibel display)

Range	Reference	Reference Resistance	Conversion Formula	Accuracy
510.00 dBm	1 mW	1-9999 Ω [*]	$10 \log_{10} [V^2 \times (1000/\text{reference resistance})]$	Add 0.3 dB to voltage measurement accuracy
510.00 dBV	1 V		$20 \log_{10} V$	

Bandwidth conforms with voltage measurement

* Initial reference resistance: 600 Ω

DC μA / mA/ A (DCA measurement)

Range	Accuracy	Overload Current	Input Impedance (Shunt resistance)	Overload Protection
510.00 μA	$\pm 0.05\% \text{rdg.}$	0.06 V	100 Ω	Protective fuse 440 mA 1000 V AC/DC Cutoff capacity 30kA
5100.0 μA	$\pm 25 \text{dgt.}^{*2}$	0.6 V		
51.000 mA	$\pm 0.15\% \text{rdg.}$	0.09 V	1 Ω	
510.00 mA	$\pm 25 \text{dgt.}^{*3}$	0.9 V		
5.1000 A	$\pm 0.2\% \text{rdg.}$ $\pm 10 \text{dgt.}$	0.2 V	0.01 Ω	
10.000 A ^{*1}	$\pm 0.2\% \text{rdg.}$ $\pm 5 \text{dgt.}$	0.4 V		

Sampling rate: 3.75 times/ s

*1: Continuous to 10 A, less than 30 seconds to 20 A, Add 0.5% rdg. to accuracy at 10 A or more.

*2: After the input is opened and the relative value (REL) display function has been initiated, the accuracy is $\pm 0.05\% \text{rdg.} \pm 5 \text{dgt.}$

*3: After the input is opened and the relative value (REL) display function has been initiated, the accuracy is $\pm 0.15\% \text{rdg.} \pm 5 \text{dgt.}$

5

AC μA / mA/ A (ACA measurement)

Range	Accuracy ^{*1}				Overload Current	Input Impedance (Shunt resistance)
	20-45Hz	45-2kHz	2k-20kHz	20k-100kHz		
510.00 μA ^{*2}	$\pm 1.5\% \text{rdg.}$ $\pm 50 \text{dgt.}$	$\pm 0.7\% \text{rdg.}$ $\pm 20 \text{dgt.}$	$\pm 3\% \text{rdg.}$ $\pm 80 \text{dgt.}$	$\pm 5\% \text{rdg.}$ $\pm 80 \text{dgt.}$	0.06 V	100 Ω
5100.0 μA	$\pm 1.5\% \text{rdg.}$ $\pm 40 \text{dgt.}$		$\pm 3\% \text{rdg.}$ $\pm 60 \text{dgt.}$		Not specified	
51.000 mA			$\pm 3\% \text{rdg.}$ $\pm 60 \text{dgt.}$	0.09 V		1 Ω
510.00 mA				0.9 V		
5.1000 A	$\pm 2\% \text{rdg.}$ $\pm 40 \text{dgt.}$ ^{*3}	$\pm 3\% \text{rdg.}$ $\pm 60 \text{dgt.}$ ^{*5}	Not specified	0.2 V	0.01 Ω	
10.000 A ^{*4}	$\pm 40 \text{dgt.}$ ^{*3}			0.4 V		

Sampling rate: 3.75 times/ s

Crest factor: 3 or less

Overload protection

$\mu\text{A}/\text{mA}$ range: Protective fuse 440 mA, 1000 V AC/DC Cutoff capacity 30 kA

A range: Protective fuse 11 A, 1000 V AC/DC Cutoff capacity 30 kA

*1: Accuracy not specified at less than 5% of range

*2: Accuracy is specified for an input current of at least 35 μA

*3: Accuracy is specified for an input current of up to 3 A

*4: Continuous to 10 A, less than 30 seconds to 20 A, Add 0.5% rdg. to accuracy at 10 A or more.

*5: Accuracy is specified for up to 3 A when exceeding 5 kHz.

AC+DC μA / mA/ A (AC+DCA measurement)

Range	Accuracy ¹			Overload Current	Input Impedance (Shunt resistance)
	20-45Hz	45-2kHz	2k-20kHz		
510.00 μA ^{*2}	$\pm 1.6\%\text{rdg.}$ $\pm 55 \text{ dgt.}$	$\pm 0.8\%\text{rdg.}$ $\pm 25 \text{ dgt.}$	$\pm 3.1\%\text{rdg.}$ $\pm 85 \text{ dgt.}$	0.06 V	100 Ω
5100.0 μA	$\pm 1.6\%\text{rdg.}$ $\pm 45 \text{ dgt.}$		$\pm 3.1\%\text{rdg.}$ $\pm 65 \text{ dgt.}$	0.6 V	
51.000 mA	$\pm 1.7\%\text{rdg.}$ $\pm 45 \text{ dgt.}$	$\pm 0.9\%\text{rdg.}$ $\pm 25 \text{ dgt.}$	$\pm 3.2\%\text{rdg.}$ $\pm 65 \text{ dgt.}$	0.09 V	1 Ω
510.00 mA				0.9 V	
5.1000 A	$\pm 2.2\%\text{rdg.}$ $\pm 50 \text{ dgt.}$ ^{*3}	$\pm 0.9\%\text{rdg.}$ $\pm 30 \text{ dgt.}$	$\pm 3.2\%\text{rdg.}$ $\pm 70 \text{ dgt.}$ ^{*5}	0.2 V	0.01 Ω
10.000 A ^{*4}	$\pm 2.2\%\text{rdg.}$ $\pm 45 \text{ dgt.}$ ^{*3}			0.4 V	

Sampling rate: 3.75 times/ s

Crest factor: 3 or less

Overload protection

$\mu\text{A}/\text{mA}$ range: Protective fuse 440mA, 1000 V AC/DC Cutoff capacity 30 kA

A range: Protective fuse 11 A, 1000 V AC/DC Cutoff capacity 30 kA

*1: Accuracy not specified at less than 5% of range (An accuracy of 45 Hz to 2 kHz is applicable only for a DC component)

*2: Accuracy is specified for an input current of at least 35 μA

*3: Accuracy is specified for an input current of up to 3 A

*4: Continuous to 10 A, less than 30 seconds to 20 A

*5: Accuracy is specified for up to 3 A when exceeding 5 kHz.

Peak Hold Function

Signal Width	Accuracy (DCmV/ DCV/ DC μA / DCmA/ DCA)
1 ms or more (one shot)	$\pm 2\%\text{rdg.} \pm 400 \text{ dgt.}$ (over entire range)
250 μs or more (repeat)	$\pm 2\%\text{rdg.} \pm 1000 \text{ dgt.}$ (over entire range)

Ω (Resistance measurement)/ Contact Check

Range	Accuracy	Measured Current	Open Terminal Voltage	Overload Protection
510.00 Ω	$\pm 0.05\% \text{rdg.} \pm 10 \text{ dgt.}^{*1}$	Approx. 1.00 mA	4.8 V	1000 V DC/ 1000 Vrms (sin) or 10^7 VHz, for 1 minute Overload current: 0.3 A or less
5.1000 k Ω	$\pm 0.05\% \text{rdg.} \pm 5 \text{ dgt.}^{*1}$	Approx. 0.38 mA		
51.000 k Ω	$\pm 0.05\% \text{rdg.} \pm 5 \text{ dgt.}$	Approx. 38 μA		
510.00 k Ω		Approx. 3.8 μA		
5.1000 M Ω	$\pm 0.15\% \text{rdg.} \pm 5 \text{ dgt.}$	Approx. 345 nA		
51.000 M Ω	$\pm 1\% \text{rdg.} \pm 10 \text{ dgt.}^{*2}$	Approx. 200 nA		
510.0 M Ω	$\pm 3\% \text{rdg.} \pm 5 \text{ dgt.}^{*3}$			
	$\pm 8\% \text{rdg.} \pm 10 \text{ dgt.}^{*4}$			
510.00 nS	$\pm 1\% \text{rdg.} \pm 10 \text{ dgt.}^{*5}$			

5

Specifications

Sampling rate: 7.5 times/ s

Continuity threshold value: Buzzer sounds less than 1000 counts for each range

*1: Accuracy is specified after the inputs are shorted and the relative value (REL) display function has been initiated

*2: Specified for humidity up to 60%RH

*3: 200 M Ω or less*4: 200 M Ω or more

*5: 50 nS or less

Diode

Range	Accuracy	Measured Current	Open Terminal Voltage	Overload Protection
2.1000 V	$\pm 0.1\% \text{rdg.} \pm 5 \text{ dgt.}$	Approx. 1.00 mA	4.8 V	1000 V DC/ 1000 Vrms (sin) or 10^7 VHz, for 1 minute Overload current: 0.3 A or less

Sampling rate: 7.5 times/ s

Continuity threshold value: Buzzer sounds at less than 0.0500 V

C (Capacitance Measurement)

Range	Accuracy	Sampling Rate (Maximum)	Overload Protection
9.999 nF	$\pm 1.5\% \text{rdg.} \pm 5 \text{ dgt.}$	4 times/ s	1000 V DC/ 1000 Vrms (sin) or 10^7 VHz, for 1 minute Overload current: 0.3 A or less
99.99 nF			
999.9 nF			
9.999 μ F			
99.99 μ F		once/ s	
999.9 μ F		0.1 time/ s	
9.999 mF		$\pm 3.5\% \text{rdg.} \pm 10 \text{ dgt.}$	
99.99 mF			

Hz (Voltage/ Current Measurement)

Range	Accuracy	Measured Current	Overload Protection
99.999 Hz	$\pm 0.02\% \text{rdg.} + 3 \text{ dgt.}$ 600 kHz or less	0.5 Hz, 1 Hz, 2 Hz, 5 Hz*	1000 V DC/ 1000 Vrms (sin) or 10^7 VHz, for 1 minute
999.99 Hz			
9.9999 kHz			
99.999 kHz			
999.99 kHz			

Sampling rate: 1.12 times/ s

Minimum frequency is set by the power on option

DUTY Ratio/ Pulse Width

Function	Range	Accuracy	Overload Protection
DUTY	99.99%	$\pm 0.3\% / \text{kHz} \pm 0.3\%$	1000 V DC/ 1000 Vrms (sin) or 10^7 VHz, for 1 minute
PULSE	510.00 ms	$\pm 0.2\% \text{rdg.} \pm 3 \text{ dgt.}$	
	1999.9 ms		

Accuracy is specified for a square wave input in the 5.1000 V DC range with an amplitude of 5 V and a pulse width of at least 10 μ s.

For AC coupling, measurement within a range of 5.00% to 95.00% is possible for a frequency signal of 20 Hz or more.

* Minimum Sensitivity Voltage (Hz/ DUTY ratio/ Pulse width Measurement)

Range	Sin Wave		DC Coupling		Accuracy Specification Maximum Voltage
	20Hz-200kHz	Exceeds 200 kHz	Less than 100 kHz	100kHz-500kHz	
51.000 mV	10 mV	25 mV	10 mV	25 mV	500 mV
510.00 mV	70 mV	150 mV	70 mV	150 mV	5 V
1000.0 mV	120 mV	300 mV	120 mV	300 mV	20 V
5.1000 V	0.3 V	0.5 V	0.6 V	1.5 V	50 V
51.000 V	3 V	5 V	6 V	15 V	500 V
510.00 V	30 V *	Not specified	60 V	Not specified	1000 V
1000.0 V	50 V *	Not specified	120 V	Not specified	1000 V

* 100 kHz or less

Minimum Sensitivity Current (Hz/ DUTY ratio/ Pulse width Measurement)

Range	Sin Wave 20Hz to 20kHz	Accuracy Specification Maximum Current
510.00 μ A	100 μ A	510 mA
5100.0 μ A	250 μ A	
51.000 mA	10 mA	
510.00 mA	25 mA	
5.1000 A	1 A	10 A
10.000 A	2.5 A	

5

Specifications

Hz (Frequency Counter) Division 1 (Sub Display "- 1 -")

Range	Accuracy	Minimum Frequency	Minimum Sensitivity Voltage	Overload Protection
99.999 Hz	$\pm 0.002\%$ rdg. ± 3 dgt. 2 MHz or less	0.5 Hz, 1 Hz, 2 Hz, 5 Hz	100 mVrms	1000 V DC/ 1000 Vrms (sin) or 10^7 VHz, for 1 minute
999.99 Hz				
9.9999 kHz				
99.999 kHz			200 mVrms	
999.99 kHz				
9.9999 MHz				

Sampling rate: 1.12 times/ s

Accuracy specified maximum input voltage: 30 Vpp

Duty ratio/pulse width display can be switched (identical accuracy specification)

* Minimum frequency is set by power on option

Hz (Frequency Counter) Division 100 (Sub Display "-100-")

Range	Accuracy	Minimum Frequency	Minimum Sensitivity Voltage	Overload Protection
9.9999 MHz	± 0.002%rdg. ± 3dgt. 20 MHz or less	1 MHz	300 mVrms	1000 V DC/ 1000 Vrms (sin) or 10 ⁷ VHz, for 1 minute
99.999 MHz			500 mVrms	

Accuracy specified maximum input voltage: 30 Vpp

Temperature

Thermocouple Type	Range	Accuracy	Overload Protection
K	-200.0 to 1372.0°C	± 0.3%rdg. ± 3°C	1000 V DC/ 1000 Vrms (sin) or 10 ⁷ VHz, for 1 minute
J	-210.0 to 1200.0°C		

Sampling rate: 3 times/ s

Accuracy does not include temperature probe error

Response time: 60 minutes

(main unit reference contact temperature compensation)

Pulse Output

Setting	Range	Resolution	Accuracy
Frequency	0.5, 1, 2, 5, 10, 15, 20, 25, 30, 40, 50, 60, 75, 80, 100, 120, 150, 200, 240, 300, 400, 480, 600, 800, 1200, 1600, 2400, 4800 Hz	0.01 Hz	± 0.005%rdg. ± 2 dgt.
DUTY ratio	0.39% to 99.60%	0.390625%	± 0.4% ^{*1, *2}
Pulse width	1/ Frequency	Range/ 256	± 0.01%rdg. ± 0.3 ms ^{*2}
Amplitude	Fixed, 2.8 V		± 0.2 V

Output impedance: 3.5 kΩ or less

*1: Accuracy: add 0.1%/kHz for frequencies in excess of 1 kHz

*2: Accuracy is specified for a positive or negative pulse width of 50 μs or more

Maintenance and Service 6

6.1 Troubleshooting

CAUTION

- If damage is suspected, check the "Troubleshooting" section before contacting your dealer or Hioki representative.
- Calibration and repair of this instrument should be performed only under the supervision of qualified technicians knowledgeable about the dangers involved.
- When transporting the instrument, pack the instrument so that it will not sustain damage during shipping, and include a description of existing damage. We cannot accept responsibility for damage incurred during shipping.
- Never modify the instrument. Only Hioki service engineers should disassemble or repair the instrument. Failure to observe these precautions may result in fire, electric shock, or injury.
- If the protective functions of the instrument are damaged, either remove it from service or mark it clearly so that others do not use it inadvertently.

When this instrument has been in extended storage (for more than one year), the instrument will not be able to meet its specifications. Be sure to have the instrument calibrated before using it.

Before returning for repair

If problems are encountered with operation, check the appropriate items below.

Symptom	Checks
Screen is blank	Is the battery dead? → Replace the battery. (81 page)
	Are the battery wires damaged? → Contact your nearest dealer.
Screen shuts off after a few moments	Is the battery dead? → Replace the battery. (81 page)
	Is the auto power save function being activated? → Check the auto power save setting. (63 page)
Cannot measure electric current	Is the fuse blown? → Replace the fuse. (83 page)
	Are the test leads damaged? → Perform a continuity check to check the test leads. If the test leads are damaged, replace the test leads. (25 page)
Position of function switch and screen display do not match	It is possible that when the unit was opened in the course of fuse replacement, the position of the function switch and the position of the switch on the circuit board became misaligned. Open the case of the unit and confirm that the function switch on the case and the indented portion of the switch on the circuit board are both in the OFF position.
Error displayed	"Error" is displayed: Is a test lead connected to terminal A while the function switch is set to something other than mA.A? → Set the function switch correctly. Connect the test leads correctly. (49 page)
	"ch Err" is displayed: Is a voltage being input to the mA.mA terminal while the function switch is set to something other than mA or mA.A? → Check whether the wrong voltage is being input to the mA.mA terminal.
Communication not possible	Is there a problem with the communication settings of the 3801-50 and the computer? → Power on option Are the baud rate and parity check set correctly (53 page), and is the communication cable connected correctly? (47 page)

If the cause of the problem still cannot be found, try resetting the system. This returns most of the system settings to their factory defaults.

❖ See Section 4.12 Reset (page 66)

6.2 Cleaning

To clean the instrument, wipe it gently with a soft cloth moistened with water or mild detergent. Never use solvents such as benzene, alcohol, acetone, ether, ketones, thinners or gasoline, as they can deform and discolor the case.

NOTE

Wipe the LCD gently with a soft, dry cloth.

6.3 Replacing the Battery



! WARNING

- To avoid electric shock, turn off the power and disconnect the test leads before replacing the batteries. After replacing the batteries, replace the cover and screws before using the instrument.
- Be sure to insert them with the correct polarity. Otherwise, poor performance or damage from battery leakage could result. Replace batteries only with the specified type.
- To avoid the possibility of explosion, do not short circuit, disassemble or incinerate batteries.
- Handle and dispose of batteries in accordance with local regulations.

6

NOTE

The “” indicator appears when battery voltage becomes low. Replace the batteries as soon as possible.

6.3 Replacing the Battery

1. Disconnect the test leads from the unit and set the function switch to OFF.

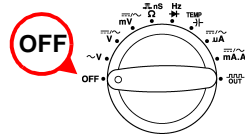

2. Detach the holster from the unit.
3. Using a Philips screwdriver, turn the battery cover screw to the OPEN position, slide the battery cover to the side, then lift the battery cover and remove it from the unit.

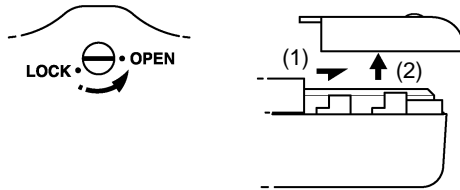

4. Disconnect the battery from the snap-on battery connector, and replace the battery with a new one. Battery type: 6F22 (manganese) or 6LR61 (alkaline)

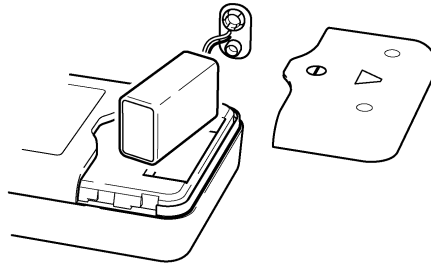

5. Close the screw on the battery cover, and then reattach the holster. When closing the case up, be careful not to pinch the wires on the snap-on battery connector. If the battery cover does not fit back into position properly, make sure that the screw is in the OPEN position.



6.4 Replacing the Fuses



- To avoid electric shock, turn off the power and disconnect the test leads before replacing the fuses. After replacing the fuses, replace the cover and screws before using the instrument.
- Replace the fuse only with one of the specified characteristics and voltage and current ratings. Using a non-specified fuse or shorting the fuse holder may cause a life-threatening hazard.
Fuse type:
 μ A.mA terminal 5019906-440 mA/ 1000 VACDC/ 30 kA (SIBA fast blowing fuse ϕ 10 X 38 mm)
 A terminal 5019906-11A/ 1000 VACDC/ 30 kA (SIBA fast blowing fuse ϕ 10 X 38 mm)
- In order to avoid electric shock and damage to the unit, make sure that the position of the function switch matches the display screen after turning on the power for the first time after replacing the fuse. It is dangerous to use this unit if the function switch does not match the display, so be sure to perform step 8 carefully.

6

Maintenance and Service

1. Disconnect the test leads from the unit and set the function switch to OFF.

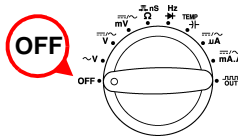

2. Detach the holster from the unit.
3. Using a Philips screwdriver, turn the battery cover screw to the OPEN position, slide the battery cover to the side, then lift the battery cover and remove it from the unit.

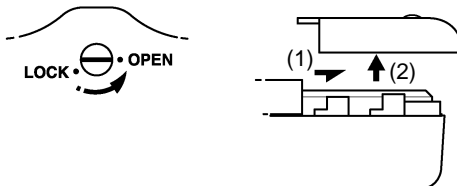

6.4 Replacing the Fuses

4. Disconnect the battery from the snap-on battery connector.
5. Remove the three screws, and then remove the lower case.

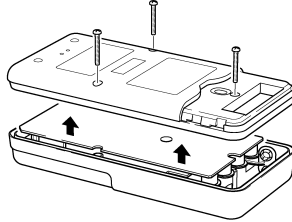

6. Pull the circuit board out of the upper case.
7. Remove the blown fuse, and replace it with a new fuse of the specified type.

Fuse type:

μ A.mA terminal 5019906-440 mA/ 1000 VACDC/ 30 kA
(SIBA fast blowing fuse ϕ 10 X 38 mm)

A terminal 5019906-11A/ 1000 VACDC/ 30 kA
(SIBA fast blowing fuse ϕ 10 X 38 mm)

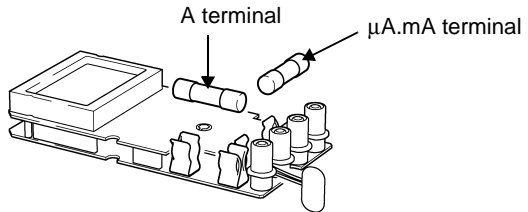

8. After confirming that both the function switch and the indented portion of the switch on the circuit board are at the OFF position, return the circuit board to the upper case.



9. Place the lower case back in position and then secure it with the three screws.
When closing the case up, be careful not to pinch the wires on the snap-on battery connector.
10. Close the screw on the battery cover, and then reattach the holster.
If the battery cover does not fit back into position properly, make sure that the screw is in the OPEN position.

6.5 Checking the Instrument Software Version

You can use the following procedure to check the version number of the instrument software.

1. Turn on the power while holding down the **REL** key.
2. Release the **REL** key while the buzzer is sounding.
3. The version number appears on the main screen.

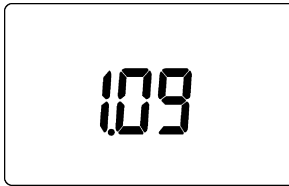

The version number on this screen is 1.09.

4. Press any key to turn on the whole display area and switch to the measurement screen.

HIOKI

DECLARATION OF CONFORMITY

Manufacturer's Name: HIOKI E.E. CORPORATION
Manufacturer's Address: 81 Koizumi, Ueda, Nagano 386-1192, Japan
Product Name: DIGITAL HiTESTER
Model Number: 3801-50
3802-50
Accessory: 3851-10 TEST LEAD
Options: 3856-01 COMMUNICATION PACKAGE
(RS-232C)
3856-02 COMMUNICATION PACKAGE
(USB)

The above mentioned products conform to the following product specifications:

Safety: EN61010-1:2001
EN61010-031:2002
EMC: EN61326:1997+A1:1998+A2:2001+A3:2003
Class B equipment
Portable test, measuring and monitoring
equipment used in low-voltage distribution
systems

Supplementary Information:

The products herewith comply with the requirements of the Low Voltage Directive 73/23/EEC and the EMC Directive 89/336/EEC.

HIOKI E.E. CORPORATION

29 September 2006

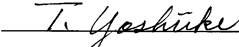

Tatsuyoshi Yoshiike
President

3801C999-01

HIOKI 3801-50 DIGITAL HiTESTER
Instruction Manual

Publication date: September 2006 Revised edition 1

Edited and published by HIOKI E.E. CORPORATION
Technical Support Section

All inquiries to International Sales and Marketing Department

81 Koizumi, Ueda, Nagano, 386-1192, Japan

TEL: +81-268-28-0562 / FAX: +81-268-28-0568

E-mail: os-com@hioki.co.jp

URL <http://www.hioki.co.jp/>

Printed in Japan 3801C980-01

-
-
- All reasonable care has been taken in the production of this manual, but if you find any points which are unclear or in error, please contact your supplier or the International Sales and Marketing Department at HIOKI headquarters.
 - In the interests of product development, the contents of this manual are subject to revision without prior notice.
 - Unauthorized reproduction or copying of this manual is prohibited.
-
-

HIOKI

HIOKI E. E. CORPORATION

HEAD OFFICE

81 Koizumi, Ueda, Nagano 386-1192, Japan

TEL +81-268-28-0562 / FAX +81-268-28-0568

E-mail: os-com@hioki.co.jp / URL <http://www.hioki.co.jp/>

HIOKI USA CORPORATION

6 Corporate Drive, Cranbury, NJ 08512, USA

TEL +1-609-409-9109 / FAX +1-609-409-9108

3801C980-01 06-09H