

3143

EARTH HiTESTER

INSTRUCTION MANUAL

Contents

Introduction	i
Inspection	i
Safety Notes	ii
Notes on Use	vi
Chapter 1 Outline	1
1.1 Product Outline	1
1.2 Features	2
1.3 Names and Functions of Parts	4
Chapter 2 Specifications	7
Chapter 3 Measurement Procedure	11
3.1 Measurement Preliminaries	12
3.2 Measuring method	13
Chapter 4 Technical Information	19
4.1 About Ground Resistance	19
4.2 Principle of Conventional Measurement of Ground Resistance (Fall-of-Potential Method)	21
4.3 Principle of Measurement on Which This Instrument is Based	22
4.4 Comparison of Values Measured by Conventional Ground Resistance Meters (Fall-of-Potential Method) and Model 3143	24

4.5 Sample Measurement (Measurement of Ground Resistance for Overhead Telecommunications Equipment and Various Types of Protectors)	26
Chapter 5 Precautions concerning Measurement	29
Chapter 6 Maintenance and Service	31
6.1 9338 CARRYING CASE	31
6.2 Replacing the Batteries	32
6.3 Cleaning the Product	34
6.4 Service	34

Introduction

Thank you for purchasing the HIOKI 3143 EARTH HiTESTER. To obtain maximum performance from the instrument, please read this manual first, and keep it handy for future reference.

Inspection

When you receive the instrument, inspect it carefully to ensure that no damage occurred during shipping. In particular, check the accessories, panel knob, and connectors. If damage is evident, or if it fails to operate according to the specifications, contact your dealer or Hioki representative.

Accessories

- 9216 CABLE WINDER (with 9265)
- 9265 MEASUREMENT CABLE
(Lead line (Black) 1 m, Return line
(Red) 20 m)
- 9338 CARRYING CASE
- Instruction Manual
- LR6 alkaline batteries (four)





Safety Notes

WARNING





This instrument is designed to comply with IEC 61010 Safety Standards, and has been thoroughly tested for safety prior to shipment. However, mishandling during use could result in injury or death, as well as damage to the instrument. Be certain that you understand the instructions and precautions in the manual before use. We disclaim any responsibility for accidents or injuries not resulting directly from instrument defects.

Safety symbols

This manual contains information and warnings essential for safe operation of the instrument and for maintaining it in safe operating condition. Before using it, be sure to carefully read the following safety precautions.

	<ul style="list-style-type: none"> • The  symbol printed on the instrument indicates that the user should refer to a corresponding topic in the manual (marked with the  symbol) before using the relevant function. • In the manual, the  symbol indicates particularly important information that the user should read before using the instrument.
	<p>Indicates DC (Direct Current).</p>

The following symbols in this manual indicate the relative importance of cautions and warnings.

	<p>Indicates that incorrect operation presents an extreme hazard that could result in serious injury or death to the user.</p>
	<p>Indicates that incorrect operation presents a significant hazard that could result in serious injury or death to the user.</p>
	<p>Indicates that incorrect operation presents a possibility of injury to the user or damage to the instrument.</p>
	<p>Indicates advisory items related to performance or correct operation of the instrument.</p>

We define measurement tolerances in terms of rdg. (reading) values, with the following meanings:

rdg. (reading or displayed value)

The value currently being measured and indicated on the measuring instrument.

Measurement categories (Overvoltage categories)

This instrument complies with CAT I safety requirements.

To ensure safe operation of measurement instruments, IEC 61010 establishes safety standards for various electrical environments, categorized as CAT I to CAT IV, and called measurement categories. These are defined as follows.

- CAT I: Secondary electrical circuits that are connected to a wall outlet through a transformer or similar device.
- CAT II: Primary electrical circuits in equipment connected to a wall outlet via a power cord (portable tools, household appliances, etc.)
- CAT III: Primary electrical circuits of heavy equipment (fixed installations) connected directly to the distribution panel, and feeders between the distribution panel and outlets.
- CAT IV: The circuit from the service drop to the service entrance, then to the power meter and to the primary overcurrent protection device.

Higher-numbered categories correspond to electrical environments with greater momentary energy. So a measurement device designed for CAT III environments can endure greater momentary energy than a device designed for CAT II.

Using a measurement instrument in an environment designated with a higher-numbered category than that for which the instrument is rated could result in a severe accident, and must be carefully avoided.

Never use a CAT I measuring instrument in CAT II, III, or IV environments.

The measurement categories comply with the Overvoltage Categories of the IEC60664 Standards.

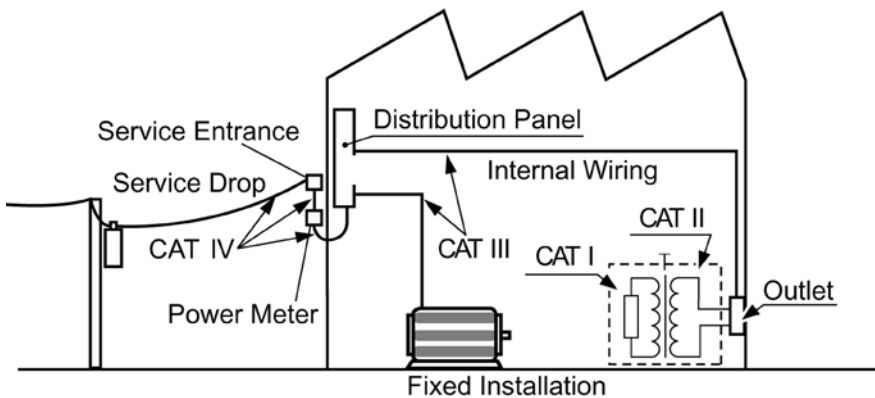



Notes on Use

Follow these precautions to ensure safe operation and to obtain the full benefits of the various functions.

Preliminary Checks

- Before using the instrument the first time, verify that it operates normally to ensure that no damage occurred during storage or shipping. If you find any damage, contact your dealer or Hioki representative.
- Before using the instrument, make sure that the insulation on the measurement cables is undamaged and that no bare conductors are improperly exposed. Using the product in such conditions could cause an electric shock, so contact your dealer or Hioki representative for replacements. (Model 9265)

** DANGER**

The ground and return measurement terminals of this instrument are designed to measure ground resistance. Accidental connection of the terminals to a commercial power source or potential-bearing object may result in electric shock. Exercise extreme care.

 WARNING

- Do not allow the instrument to get wet, and do not take measurements with wet hands. This may cause an electric shock.
- To avoid electric shock, do not connect or disconnect measurement cables while the instrument is wet.
- Do not use the instrument where it may be exposed to corrosive or combustible gases. The instrument may be damaged or cause an explosion.
- Do not mix old and new batteries, or different types of batteries. Also, be careful to observe battery polarity during installation. Otherwise, poor performance or damage from battery leakage could result.

**⚠ WARNING**

- **To avoid electric shock, turn the power switch off and disconnect the measurement cables before replacing the batteries.**
- **To avoid the possibility of explosion, do not short circuit, disassemble or incinerate batteries.**
- **Handle and dispose of batteries in accordance with local regulations.**

⚠ CAUTION

- Do not store or use the instrument where it could be exposed to direct sunlight, high temperature or humidity, or condensation. Under such conditions, the instrument may be damaged and insulation may deteriorate so that it no longer meets specifications.
- For safety reasons, when taking measurements, only use the 9265 MEASUREMENT CABLE provided with the instrument.
- To avoid breaking the measurement cables, do not bend or pull them.
- Use only the specified battery type (LR6 alkaline battery). Manganese batteries, for example, will provide insufficient service life.

⚠ CAUTION

- To avoid corrosion from battery leakage, remove the batteries from the instrument if it is to be stored for a long time.
- To avoid damage to the instrument, protect it from physical shock when transporting and handling. Be especially careful to avoid physical shock from dropping.
- Although this instrument is designed to resist the semi-ingress of dust and water, it is not entirely water- or dust-proof, so to avoid shock or damage, do not use it in a wet or dusty environment.
- If the protective functions of the instrument are damaged, either remove it from service or mark it clearly so that others do not use it inadvertently.
- Calibration and repair of this instrument should be performed only under the supervision of qualified technicians knowledgeable about the dangers involved.

NOTE

- The **B** indicator appears when battery voltage becomes low. Replace the batteries as soon as possible.
- To clean the instrument, wipe it gently with a soft cloth moistened with water or mild detergent. Never use solvents such as benzene, alcohol, acetone, ether, ketones, thinners or gasoline, as they can deform and discolor the case.
- After use there is still a drain on the battery, be sure to turn the power switch off.

Chapter 1

Outline

1.1 Product Outline

In contrast to conventional 3-pole type ground resistance meters, this instrument allows easy measurement of ground resistances, with no need to drive auxiliary earthing electrodes into the ground - whether soil or asphalt. This is particularly useful when ground resistances need to be measured in urban environments, in which driving auxiliary earthing electrodes into the ground is not easy or practical. The instrument is best suited to the measurement of ground resistances for grounding connections that use individual bar-type earthing electrodes for telecommunications equipment installed on poles (overhead telecommunications equipment), and for telecommunications equipment protectors.

NOTE

Model 3143 was designed and commercially produced using technology originally devised by the Technical Cooperation Center of NTT East.

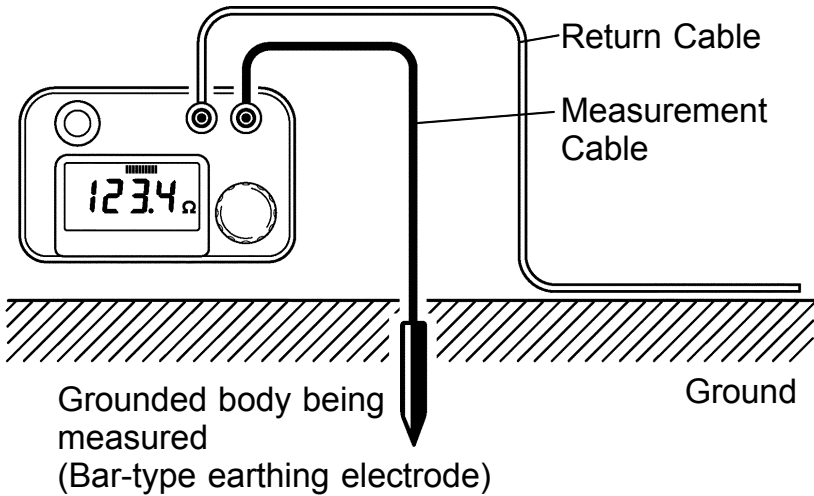

Figure 1

1.2 Features

(1) No need to drive auxiliary earthing electrodes into the ground

Allows easy measurement of ground resistances, simply by connecting the earthing electrode to the measurement terminals (Ground side) of the instrument and the return line (red line) to the other terminal (Return side) and placing the return line on the ground.

(2) Ideally suited to measurements of bar-type earthing electrodes

The instrument allows easy measurement of the ground resistances of individual bar-type earthing electrodes for overhead telecommunications equipment protectors.

(3) Reduces the effects of ground voltage

The instrument uses a synchronous detection system, with the return line placed directly on the ground in an electrically insulated state. This reduces the adverse effects of higher harmonic ground voltages of commercial frequency to ensure stable measurement.

(4) Semi-dust-proof construction

Measurement switches, indicators and other moving parts are designed to withstand use in tough environments.

(5) Easy to use

The supplied carrying case is designed to hold the instrument and all accessories. A cable winder is standard, making it easy to deploy and store measurement cables.

1.3 Names and Functions of Parts

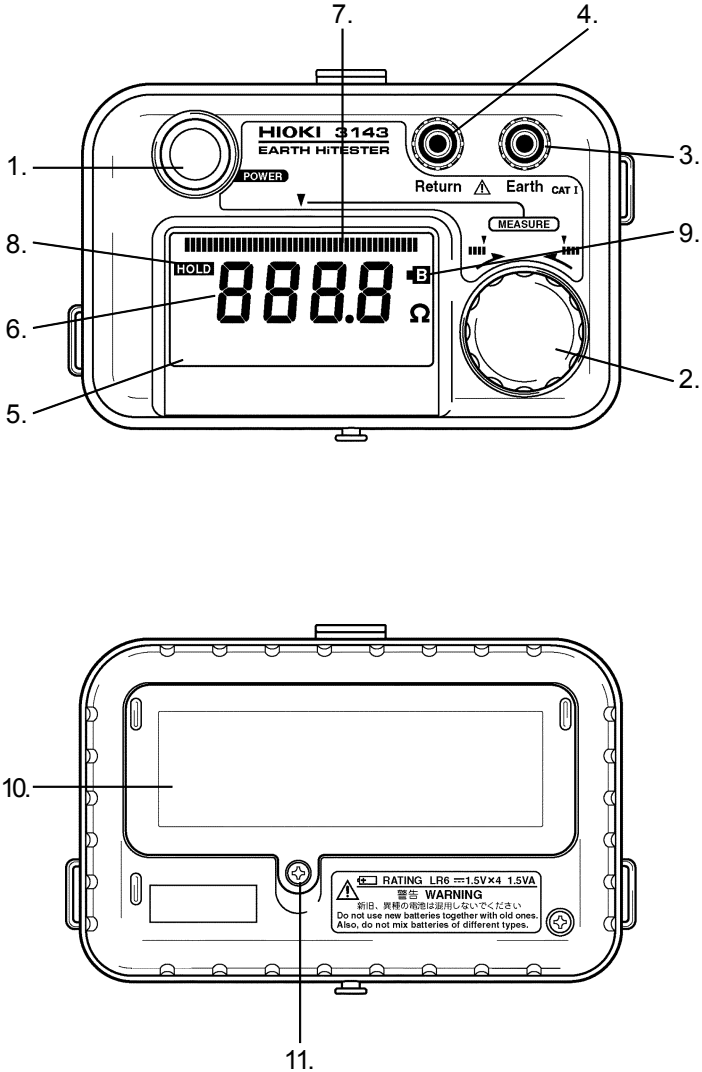

Figure 2

1. Power switch (POWER)
Instrument power switch
2. Measuring knob (MEASURE)
Knob for measuring ground resistances. Turn the knob until the instrument indicates a minimum resistance value.
3. Earth: Earthing electrode terminal
Terminal to which the earthing electrode is connected, via the lead line (black).
4. Return: Return terminal
Terminal to which the return line (red) is connected. Position the return cable directly on the ground.
5. LCD display
6. Measured ground resistance value
7. Measurement indicator bar
Indicates the direction in which the measuring knob (MEASURE) is to be turned. Turn the knob to shrink the indicator bar.
8. Hold indication
Following measurement, the display retains the value of the last value measured. If the measuring knob (MEASURE) is left untouched for about 3 minutes, the instrument will enter Hold status. Turning the knob cancels Hold status and resumes measurement.

9. Battery check

Indicates that the batteries have been exhausted. Replace the batteries.

10. Battery cover

11. Fixing screw on the battery cover

Chapter 2

Specifications

<Measurement>

Measurement method	<p>Voltage ratio method (measures the voltage under the series resonance of a loop impedance [Note].)</p> <p>When measured with the lead line connected to the earthing electrode being measured and the return line placed directly on the ground, the resistance value sought is the one that appears as the minimum value in the display as the measuring knob is turned.</p> <p>Note: Loop impedance refers to a series circuit composed of the inductance of the lead line, the grounding capacity of the return line, and the measured ground resistance.</p>
--------------------	---

Measured resistance range	20 - 500 Ω
---------------------------	-------------------

Measurement accuracy (in the operating temperature range)	<p>$\pm 5\%$ rdg. (50-500 Ω)</p> <p>$\pm 10\%$ rdg. (20-50 Ω)</p> <p>Note: With the inspection jig based on a dummy resistance</p>
--	--

Effect of ground voltage (50/60 Hz)	$\pm 5\%$ rdg. at 0 - 10 V
-------------------------------------	----------------------------

Detection system	Synchronous detection system
------------------	------------------------------

A/D conversion	<p>10-bit successive approximation type A/D converter</p> <p>Synchronous detection + LPF output sampled</p> <p>Sampling interval: 96 ms/S</p>
----------------	---

<Correction method for measured values>	
Averaging processing	Sampled values are subjected to averaging, and the resulting value is indicated as a measured value.
<Signaling source for measurement>	
Frequency range	100 kHz - 1.5 MHz Adjustable using the measuring knob on the front panel
Frequency variation resolution	240 Hz
Output voltage between terminals	0.9 V _p AC, typical
Output resistance between terminals	200 Ω ± 1% The short-circuit current between terminals is 3.6 mA AC, max.
<Display>	
Indication method	4-digit LCD display Display range from 0.0 to 999.9 Ω "OF" displayed for resistances over 999.9 Ω "OL" displayed when an attempt is made to vary down to below 100 kHz or up to over 1.5 MHz with the measuring knob.
Types of indications	Measured resistance value (Ω), indicator bar graph (provides a rough guide to the position of the resonance point), battery mark, and "HOLD" mark.
<Environment>	
Operating temperature and humidity range	0 to 40°C (32°F to 104°F), 80% RH or less (with no condensation)

Storage temperature and humidity range	-10 to 50°C (14°F to 122°F), 80% RH or less (with no condensation)
Location of use	Altitude up to 2000 m (6562 feet)
<Power supply>	
Power supply	Four LR6 alkaline batteries Rated supply voltage: 1.5 V x 4
Maximum rated power	1.5 VA max
Battery Life	Approx. 8 hours (continuous, 23°C)
<Over view>	
External dimensions	Approx. 155 W x 98 H x 49 D mm (Approx. 6.10"W x 3.86"H x 1.93"D) (excluding protrusion)
Mass	Approx. 380 g (Approx. 13.4 oz.) (instrument only)
<Standards applying>	
Safety	EN 61010-1:2001 Pollution Degree 2, Measurement Category I (anticipated transient overvoltage 330 V)
EMC	EN 61326:1997+A1:1998+A2:2001+A3:2003 Class B

<Ancillary functions>

Power Saving mode	<p>The instrument enters Power Saving mode if the measuring knob is left untouched for about 3 minutes. Output of the measurement signaling source is halted. The LCD displays "HOLD." Turn the measuring knob to wake the instrument from Power Saving mode.</p>
Indicator	<p>Indicates an approximate position of the resonance point of the loop impedance on a bar graph. When the bar graph is situated near the center of the display, it indicates that the loop impedance is near the resonance point.</p>
Battery check	<p>The battery check indication appears when the battery voltage falls below the rated supply voltage of 4.4 V.</p>
Accessories	<p>9216 CABLE WINDER (with 9265) 9265 MEASUREMENT CABLE (Lead line (Black) 1 m, Return line (Red) 20 m) 9338 CARRYING CASE Instruction Manual LR6 alkaline batteries (four)</p>



Chapter 3

Measurement Procedure

 **DANGER**

The ground and return measurement terminals of this instrument are designed to measure ground resistance. Accidental connection of the terminals to a commercial power source or potential-bearing object may result in electric shock. Exercise extreme care.

 **WARNING**

- Do not allow the instrument to get wet, and do not take measurements with wet hands. This may cause an electric shock.
- To avoid electric shock, do not connect or disconnect measurement cables while the instrument is wet.
- Do not use the instrument where it may be exposed to corrosive or combustible gases. The instrument may be damaged or cause an explosion.

**⚠ WARNING**

- **Do not mix old and new batteries, or different types of batteries. Also, be careful to observe battery polarity during installation. Otherwise, poor performance or damage from battery leakage could result.**

⚠ CAUTION

- Use only the specified battery type (AA alkaline). Manganese batteries, for example, will provide insufficient service life.
- To avoid corrosion from battery leakage, remove the batteries from the instrument if it is to be stored for a long time.

3.1 Measurement Preliminaries

- (1) Turn on the POWER switch and make sure that the LCD display lights. "OF" is displayed if nothing is connected to the measurement terminals.
- (2) Check to see if the battery check mark  is on. If this mark stays on, it indicates that the batteries have run down. Replace them with new ones. (See "6.2 Replacing the Batteries.")

3.2 Measuring method

(1) Connecting the cables

Connect the measurement cables 9265 supplied with the instrument, as shown in Figure 3. (Couple the lead line [black] to the ground terminal, and the return line [red] to the Return terminal.) Connect the other end of the lead line to the buried earthing electrode and lay the return line on the ground (on paved concrete or asphalt).

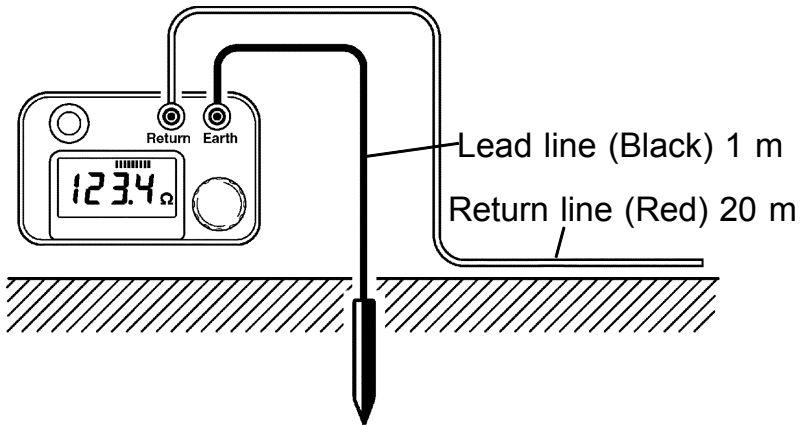

Figure 3. Connection Diagram

NOTE

- Use only the measurement cables supplied with the instrument. Use of any other cable will result in inaccurate measurements.
- Lay the return line directly on the ground in a straight line, confirming that the cable remains in contact with the ground. Correct measurements are not possible if the cable is tangled or forms loops. Particularly with turf or rock beds, try to place the return line in close contact with the ground to the maximum extent possible.
- Connect the lead line directly to the earthing electrode being measured. If for unavoidable reasons the lead line must be tied to the ground wire extending from the earthing electrode, limit total length to 5 meters.
- Connect the lead line at a point as close as possible to the point at which the earthing electrode was buried.

(2) Measurement of ground resistance value

Turn the measuring knob (MEASURE) to find the lowest indicated value. The lowest value represents the resistance value of the earthing electrode being sought. Turn the measuring knob as follows:

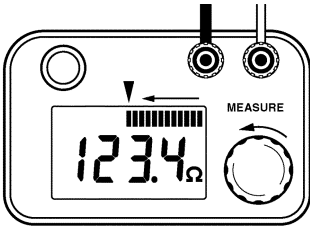

Figure 4(a).

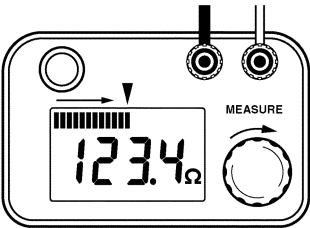

Figure 4(b).

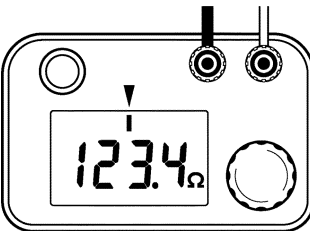

Figure 4(c)

- 1) The measurement indicator bar shows the direction in which the knob should be turned.

If the indicator bar appears as shown in Figure 4(a), turn the knob counterclockwise to bring the indicator bar to the "▼" position. (See Figure 4(c).)

If the indicator bar appears as shown in Figure 4(b), turn the knob clockwise.

- 2) Closely observing the measured value, slowly turn the knob to find the minimum value. (Figure 4(c))

- 3) When you stop turning the knob, the measured value appearing in the display will stabilize.

NOTE

- The measurement indicator bar displayed may not stabilize, depending on the resistance value of the grounded body being measured or the environment in which the return line is laid. Particularly for measurements of large ground resistances, no minimum value may be shown, even when the indicator bar is located in the center of the display. If so, turn the knob to minimize the indication value.
- If the measured resistance value is 1000 Ω or more, the LCD will display "OF." Turn the knob, using the orientation of the indicator bar as a guide, and seek the point for a minimum measured value.
- If you keep turning the knob in a given direction until the LCD displays "OL," turning the knob further will not vary the measured value. Try turning the knob in the opposite direction and seek the minimum measured value.

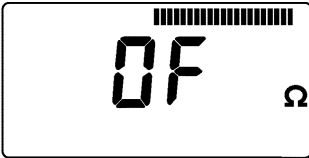

(3) Hold status

The instrument will enter Hold status if the measuring knob (MEASURE) is left untouched for about 3 minutes ("HOLD" is displayed: see Figure 5), with the value measured immediately before the Hold state retained on the display. In addition, the signal from the measurement terminals (between the Ground - Return terminals) is interrupted. Turning the knob in this status cancels Hold and resumes measurement.

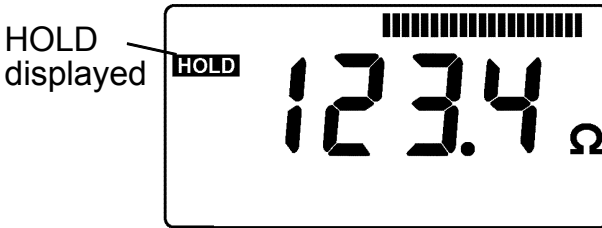

Figure 5. Hold State

(4) Battery check

See if the battery check mark (ⓑ) is on. If yes, the batteries have run down and need to be replaced. (See "6.2 Replacing the Batteries.")

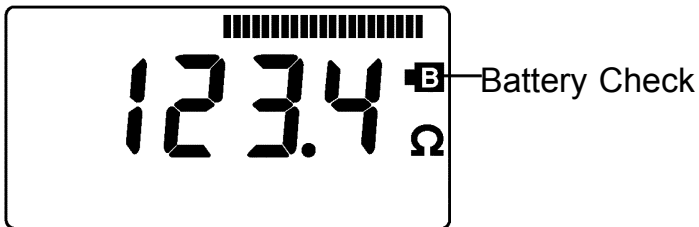

Figure 6. Battery Check

Chapter 4

Technical Information

This chapter explains the definition of generic ground resistance, types of grounding implementations, principles of measurement of typical ground resistances, and describes grounding methods/implementations and resistance measurements for overhead telecommunications equipment and protectors, as exemplified in typical measurement situations.

4.1 About Ground Resistance

(1) What is ground resistance?

Ground resistance refers to electrical resistance between a metal earthing electrode and soil (a mixture of soil particles, water, and air) and is specified in many legal codes and standards as part of the safety criteria to be observed in the construction of electrical installations. In general, ground resistance is defined as the ratio E/I (Ω) of the current I (A) flowing from a earthing electrode to the ground to the rise of the potential E (V) generated by such a current.

(2) Leakage current and ground voltage

In ordinary ground resistance measurements, external influences include leakage current from connected equipment and ground voltage created by ground current. Since the return line of the instrument is laid on the ground in an electrically insulated state, the instrument is relatively resistant to the adverse effects of leakage currents and ground voltages generated by higher harmonics (up to 1 kHz or so) generated by commercial power.

4.2 Principle of Conventional Measurement of Ground Resistance (Fall-of-Potential Method)

Most ground resistance meters perform measurements based on the fall-of-potential method. These types of meters are widely used in the measurement of the low resistance to the high resistance. This method requires driving into the earth an auxiliary current electrode (electrode C) to inject measuring current and an auxiliary potential electrode (electrode P) to measure the rise of potential, in addition to the grounding electrode (electrode E). From grounding current $I(\text{A})$ and the corresponding fall-of-potential $V(\text{V})$, ground resistance value R_g is given by the following equation:

$$R_g = \frac{V}{I}$$

Figure 7 shows a potential distribution curve obtained when auxiliary electrodes are driven into the ground. Electrode P must be driven into the ground at the point in the figure at which the potential distribution curve is flat. For this reason, the distance between electrodes C and E must be made sufficiently large. Additionally, measurement errors will be produced if electrode P is not driven into a point 61.8% between electrodes E and C.

Driving in auxiliary electrodes is difficult at sites where the ground is paved with concrete or asphalt, resulting in reduced work efficiency.

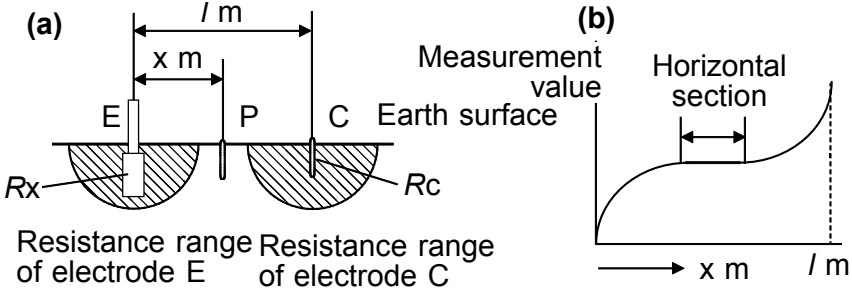

4.3 Principle of Measurement on Which This Instrument is Based

When the earthing electrode is connected to the ground terminal of this instrument through the lead line, and the return line connected to the Return terminal is laid on the ground, a closed circuit is composed of inductance Lg of the lead wire \rightarrow ground resistance $Rg \rightarrow$ ground \rightarrow ground resistance R of return line and the earth, and electrostatic capacity Cg . This instrument measures the loop impedance under the resonance of this closed circuit and calculates ground resistance Rg . Figure 8 shows an equivalent model. Equivalent resistance R' at the time of resonance, as viewed from measurement signaling line Vc , results as follows (R_{out} is the output resistance of this instrument):

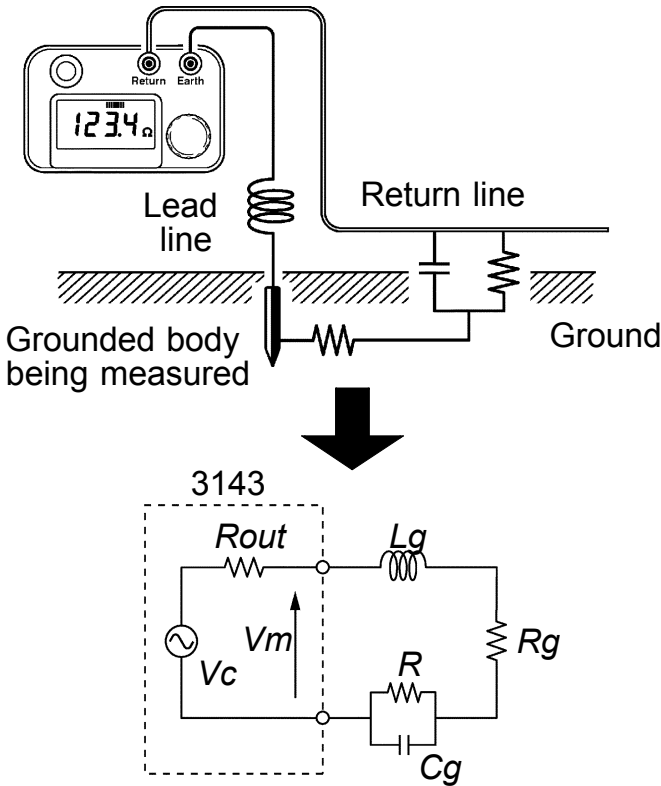

Figure 8. Diagram of Measurement Principle

$$R' = R_{out} + R_g + \frac{R}{1 + (\omega C_g R)^2} \cong R_{out} + R_g$$

As shown above, R' represents the sum of ground resistance R_g and R_{out} . If the voltage V_m between the measurement terminals is measured, ground resistance R_g may be calculated by the voltage ratio method.

$$R_g = \frac{1}{(V_c/V_m) - 1} R_{out}$$

In passing, the resonance frequency will be high - around 1 MHz - although it will vary somewhat with varying geological features, water content, and degree of soil compaction. Since this frequency band corresponds to the duration of the wave front of a lightning surge, measurements of ground resistances using this instrument may be regarded as similar to the evaluation of surge impedances.

4.4 Comparison of Values Measured by Conventional Ground Resistance Meters (Fall-of-Potential Method) and Model 3143

Figure 9 represents the correlation between the measurement of ground resistances of bar-type electrodes by the fall-of-potential method (3-pole method) and a measurement conducted with the 3143, while Figure 10 indicates rdg. errors of the 3143 with respect to the values of the 3-pole method defined as true values. In the figure, it is apparent that values obtained by the 3143 match those of the 3-pole method in the range from 10 to 20% rdg. when ground resistances range from 50 to 500 Ω .

Moreover, the rdg. errors tend to increase in the range from 20 to 50 Ω .

At this point, it should be noted that Figures 9 and 10 include measurement errors (resistances of auxiliary earthing electrodes, effects of ground voltage, etc.) of the 3-pole method. Use this data for reference only.

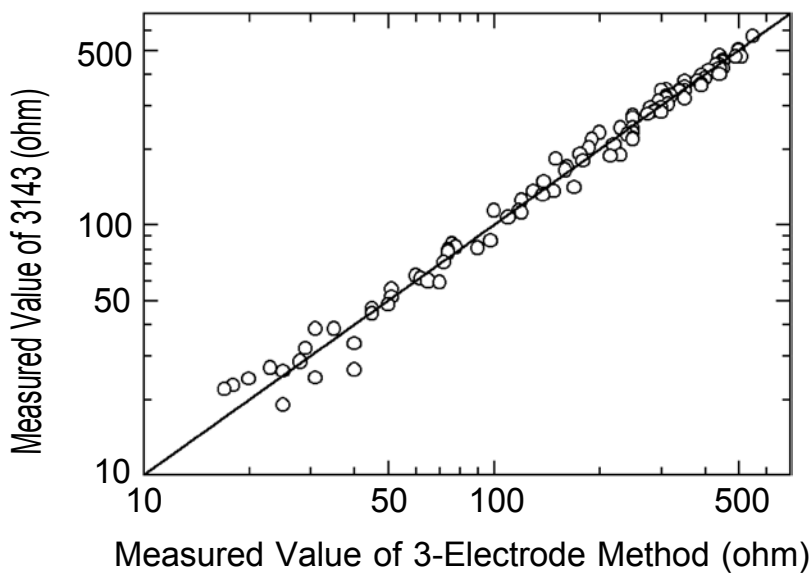

Figure 9. Correlation between Values Measured by 3-Electrode Method and with the 3143

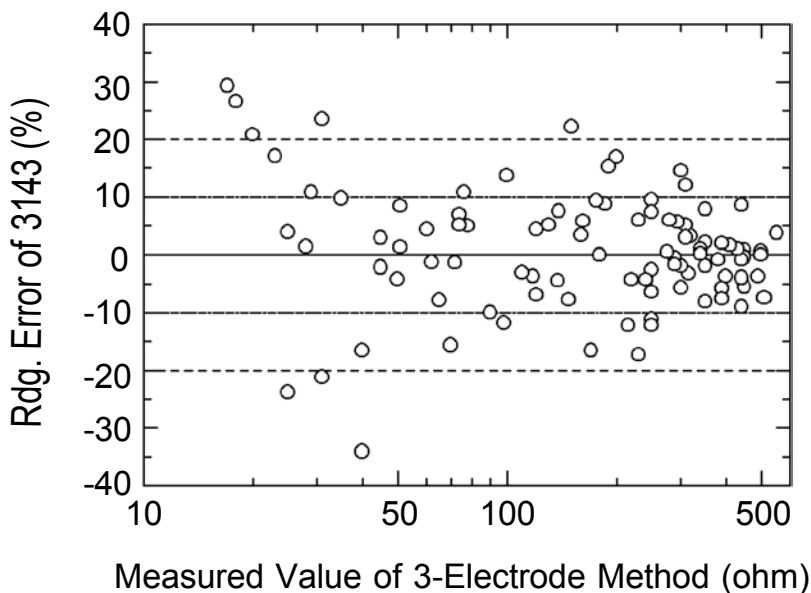

Figure 10. Rdg. Errors of 3143 with Respect to 3-Electrode Method

4.5 Sample Measurement (Measurement of Ground Resistance for Overhead Telecommunications Equipment and Various Types of Protectors)

It is increasingly common to find some switching and transmission equipment functions formerly located within telecommunications center buildings on or near the premises of residences. This configuration makes it possible to provide diverse information services through various types of networks. Such equipment handles high speed and high volume telecommunications traffic and must also have adequate resistance and strength to protect both people and equipment from lightning and leaks. Thus, grounding implementations involving overhead telecommunications equipment and protectors are more important now than ever before. In particular, protectors discharge lightning surges passing from communication lines to the ground.

Provided below are potential environments surrounding overhead telecommunications equipment and various types of protectors:

- (1) It is necessary to confirm that the ground resistance value obtained following grounding implementation is lower than the value specified in a standard for safety of each country.
- (2) Many of the work sites are in residential and office building areas, which means that most of the ground surface is asphalted, making it time and labor-consuming to drive in auxiliary earthing electrodes using the conventional 3-pole method.

Under these conditions, this instrument provides the following advantages:

- (1) No need to drive in auxiliary earthing electrodes, saving time and labor.
- (2) The digital display of measured values allows immediate assessment to determine whether or not the ground resistance is lower than the value specified in a standard for safety.

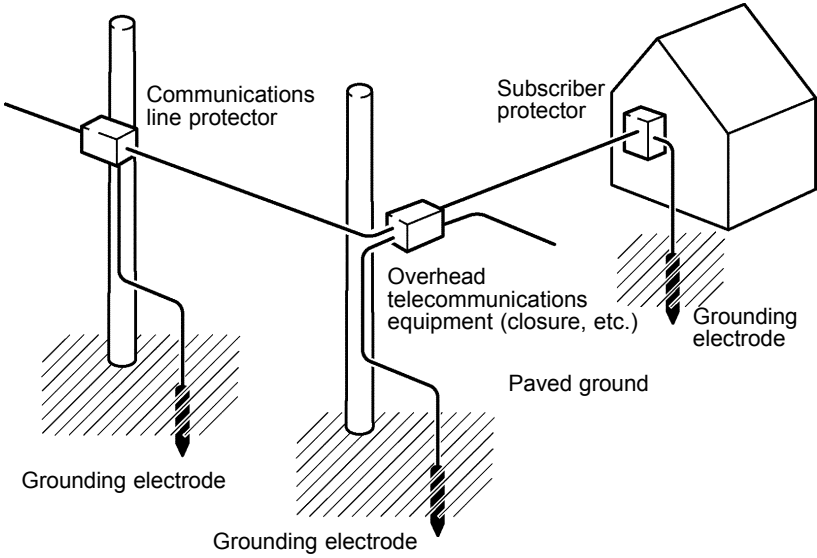

Figure 12. Environment Surrounding Overhead Telecommunications Equipment and Protector

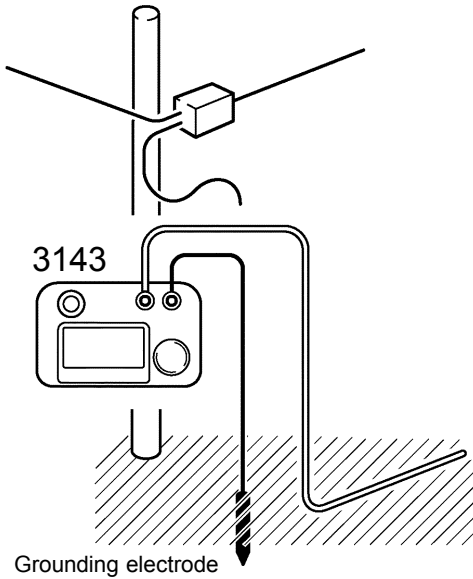

Figure 13. Example of 3143 Use

Chapter 5

Precautions concerning Measurement

This instrument measures ground resistances based on a new measurement principle. For this reason, depending on the grounded body, the values obtained with it may vary from those measured by the traditional 3-pole method. Carefully read the following precautionary notes before using this instrument.

- (1) The 3143 is suitable for measuring the ground resistances of independent bar-type electrodes. Measurement results obtained by the conventional 3-pole method may appear somewhat larger in comparison when the measurement is performed at the following locations:
 - Grounding connections implemented by the parallel grounding method, with a concatenation of multiple earthing electrodes or net-type electrodes - such as a mesh.
 - Grounding connections implemented by a deep-driven grounding method that buries earthing electrodes deep in the ground.

For resistance measurements with safety implications, especially grounding connectors for power facilities, double-check resistance values using the 3-pole method.

- (2) Use only the measurement cables (9265 MEASUREMENT CABLE) supplied with the instrument. Use of other cables may result in measurement errors.
- (3) Lay the return line directly on the ground, ensuring contact with the ground. Correct measurement results are not possible if the return line loops or folds back on itself. Close contact with the ground surface is particularly important on turf or rock bed surfaces.
- (4) Connect the lead line at a point as close as possible to the point at which the earthing electrode is buried.

Chapter 6

Maintenance and Service

6.1 9338 CARRYING CASE

The 9338 CARRYING CASE is designed exclusively for this instrument and is capable of accommodating 9265 MEASUREMENT CABLE and four AA batteries in addition to the instrument itself. With the upper cover rotated as shown in Figure 14, measurements can be made without removing the instrument from the case. To avoid damage from external shocks, always place the instrument in its carrying case at the end of each measurement session.

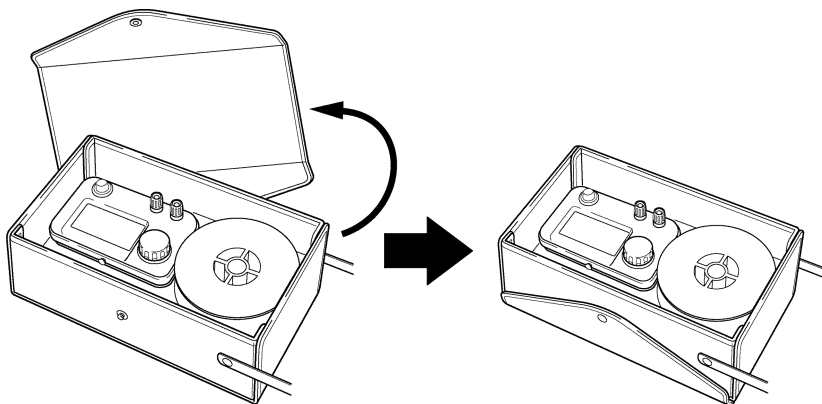

Figure 14.



6.2 Replacing the Batteries

⚠ WARNING

- **To avoid electric shock, turn the power switch off and disconnect the measurement cables before replacing the batteries. After replacing the batteries, replace the cover and screws before using the instrument.**
- **To avoid the possibility of explosion, do not short circuit, disassemble or incinerate batteries.**
- **Handle and dispose of batteries in accordance with local regulations.**

NOTE

- Use only the specified battery type (AA alkaline). Manganese batteries, for example, will provide insufficient service life.
- To avoid corrosion from battery leakage, remove the batteries from the instrument if it is to be stored for a long time.

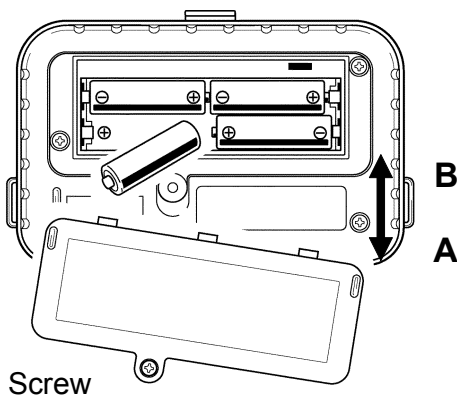

Figure 15.

1. For safety, disconnect the measurement cables from the instrument.
2. Remove the fastening screw.
3. Remove the cover of the battery compartment in direction A, as shown in the illustration.
4. Replace all four batteries with fresh ones.
5. Reattach the cover of the battery compartment in direction B, as shown in the illustration.
6. Fasten the battery compartment cover to the instrument with the fastening screw.

6.3 Cleaning the Product

- To clean the instrument, wipe it gently with a soft cloth moistened with water or mild detergent. Never use solvents such as benzene, alcohol, acetone, ether, ketones, thinners or gasoline, as they can deform and discolor the case.

6.4 Service

If the instrument seems to be malfunctioning, confirm that the batteries are not discharged, and that the measurement cable is not open circuited before contacting your dealer or Hioki representative. Pack the instrument so that it will not sustain damage during shipping, and include a description of existing damage. We cannot accept responsibility for damage incurred during shipping.

HIOKI

DECLARATION OF CONFORMITY

Manufacturer's Name: HIOKI E.E. CORPORATION
Manufacturer's Address: 81 Koizumi, Ueda, Nagano 386-1192, Japan
Product Name: EARTH HiTESTER
Model Number: 3143
Accessory: 9265 MEASUREMENT CABLE

The above mentioned products conform to the following product specifications:

Safety: EN61010-1:2001
EMC: EN61326:1997+A1:1998+A2:2001+A3:2003
Class B equipment
Portable test, measuring and monitoring
equipment used in low-voltage distribution
systems

Supplementary Information:

The products herewith comply with the requirements of the EMC Directive 89/336/EEC, but is not applicable to the Low Voltage Directive 73/23/EEC.

HIOKI E.E. CORPORATION

15 September 2006



Tatsuyoshi Yoshiike
President

3143A999-03

HIOKI 3143 EARTH HiTESTER

Instruction Manual

Publication date: September 2006 Revised edition 4

Edited and published by HIOKI E.E. CORPORATION
Technical Sales Support Section

All inquiries to International Sales and Marketing
Department

81 Koizumi, Ueda, Nagano, 386-1192, Japan

FAX: 0268-28-0568 TEL: 0268-28-0562

E-mail: os-com@hioki.co.jp

URL <http://www.hioki.co.jp/>

Printed in Japan 3143A980-04

- All reasonable care has been taken in the production of this manual, but if you find any points which are unclear or in error, please contact your supplier or the International Sales and Marketing Department at HIOKI headquarters.
- In the interests of product development, the contents of this manual are subject to revision without prior notice.
- Unauthorized reproduction or copying of this manual is prohibited.

HIOKI

HIOKI E. E. CORPORATION

HEAD OFFICE

81 Koizumi, Ueda, Nagano 386-1192, Japan
TEL +81-268-28-0562 / FAX +81-268-28-0568
E-mail: os-com@hioki.co.jp
URL: <http://www.hioki.co.jp/>

HIOKI USA CORPORATION

6 Corporate Drive, Cranbury, NJ 08512, USA
TEL +1-609-409-9109 / FAX +1-609-409-9108



3143A980-04 06-09H

Printed on recycled paper
