

BMW E60/61/90 SPECIFICATION

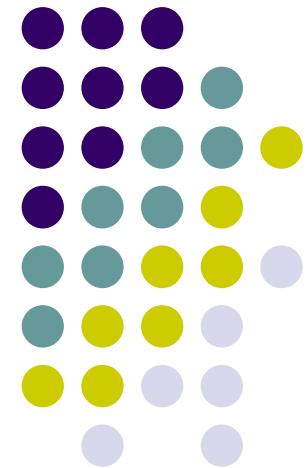

- . MODEL: QVL-BMW-STD-V2

- . Product Code : BM-0806-101



INDEX



- Updated points on this version
- Precaution
- Main Spec.
- System Composition
- Outline Dimension
- External Appearance
- Connector Pin Assignment
- DIP Switch Setting
- How to use OSD Keypad
- OSD (On Screen Display)
- FMTX Frequency Setting
- How to use parking guide line
- CAN Wiring
- Product Composition
- FAQ

Updated points on this version

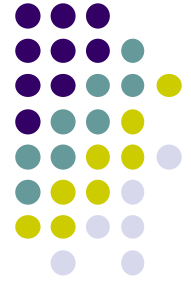

- FMTX Module is added in the product. (No need additional FMTX Module for Audio)
- Offering OSD Key Pad
(The remote control is not offered anymore)
- Possible to move the displayed position of Navi (Only on RGB mode)
- Changed OSD MENU

Precaution



- You must keep the car key taken off from the car while you work this and finally, connect power of the interface.
- When to connect the interface cable, you must keep the power cable taken off.
- You must work this at the environment without any static electricity or damages.
- All of process on this installation should be done by professionals.
- You must not break the labels attached on the board, if it's broken, no warranty.
- When you receive this package you have to check whether there's any parts not included and you have to contact us right away.
- Our repair service do not accept any problems caused by user's any fault or carelessness.

Main Spec.



1. Input Spec. (MULTI VIDEO INTERFACE)
 - 1 x Analog R,G,B (Sync on Green)
 - 1 x CVBS(REAR CAMERA) Input. (Rear camera source)
 - 3 x AV (NTST & PAL) Input.
 - 1 x LCD Input (Car system Input)

2. Output Spec.
 - 2 X CVBS OUTPUT (Video Out for installing Headrest monitor)
 - 1 x Audio OUTPUT
 - 1 X LCD OUTPUT(LCD Operation)

3. Electric Power Consumption
 - Input Power : 8VDC ~ 24VDC
 - Consumption Power : 12WATT, Max

4. Switching Mode (AV source)
 - Possible to skip AV source while switching Mode (AV source) by DIP S/W (Refer to the DIP S/W page)
 - By 'SET' button of the OSD Keypad
 - By Toggle Switch (Option)
 - By 'Menu' button of the car through CAN

System Composition

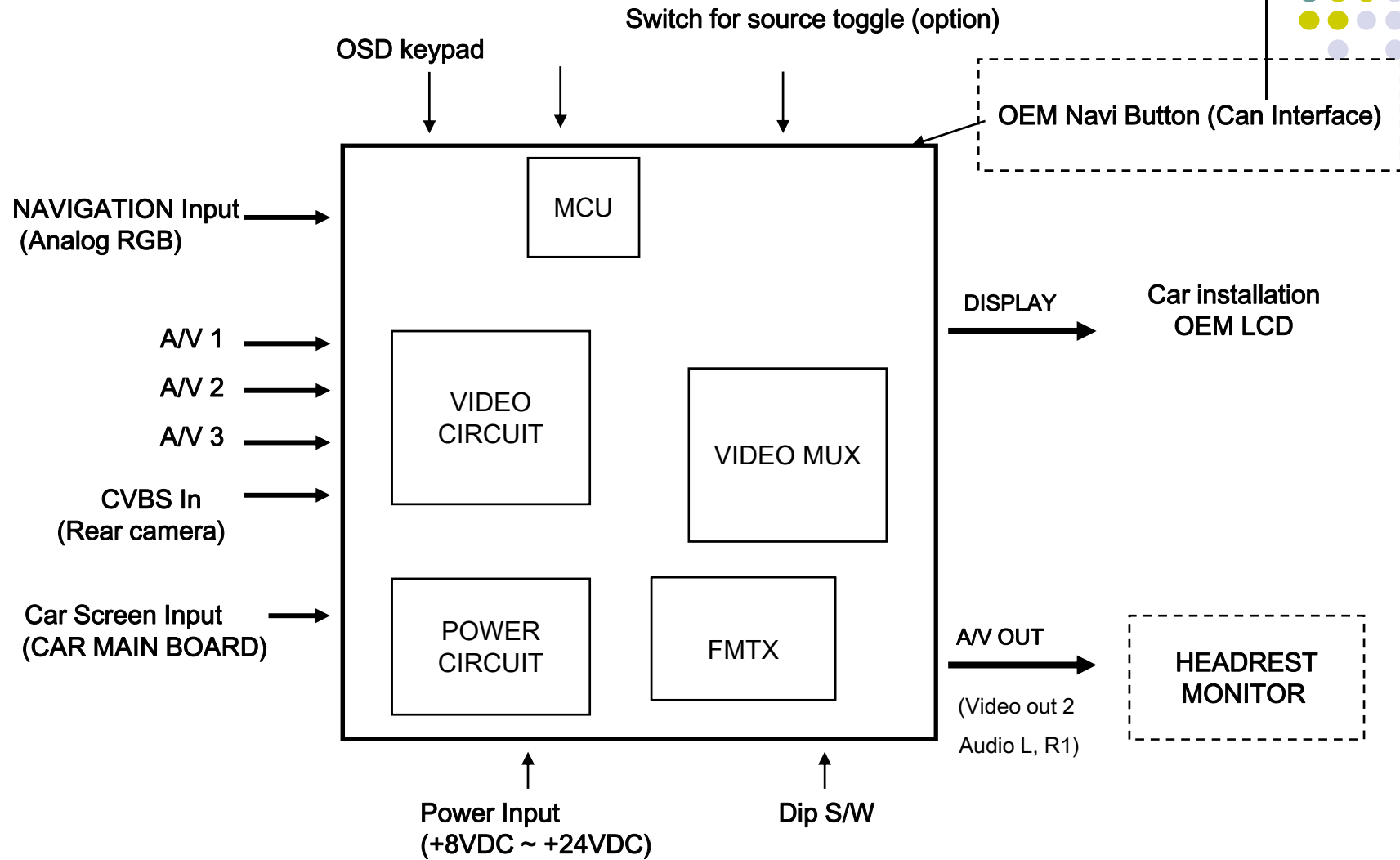

Outline Dimension

147mm * 92mm * 20mm



※ This can change under manufacturer's circumstance

External Appearance

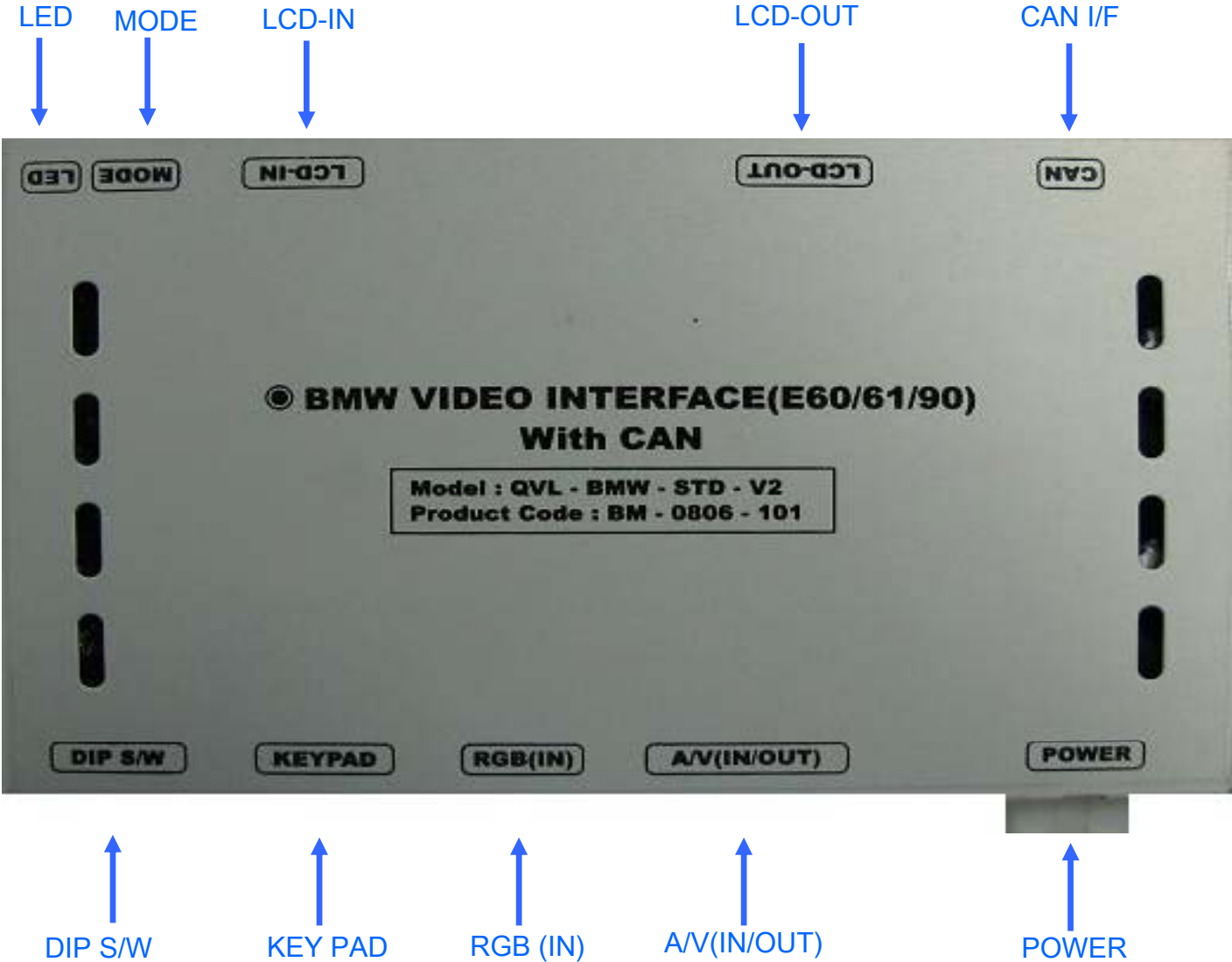

※ This can change under manufacturer's circumstance

External Appearance

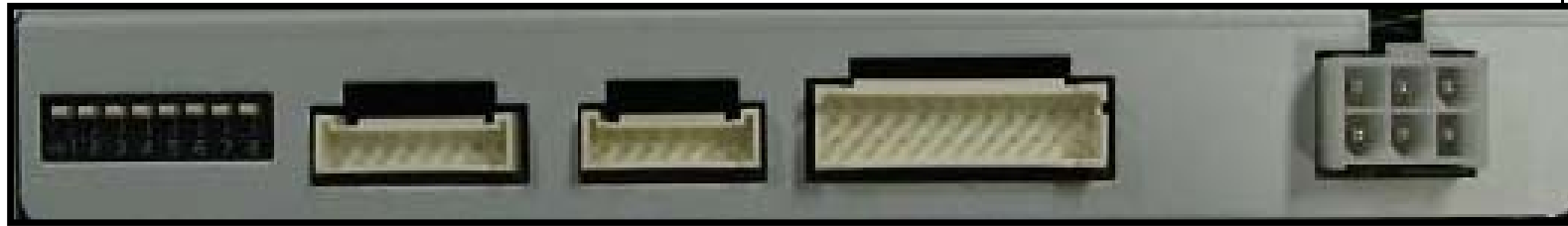

↑
DIP S/W

↑
KEY PAD

↑
RGB(IN)

↑
AV(IN/OUT)

↑
POWER

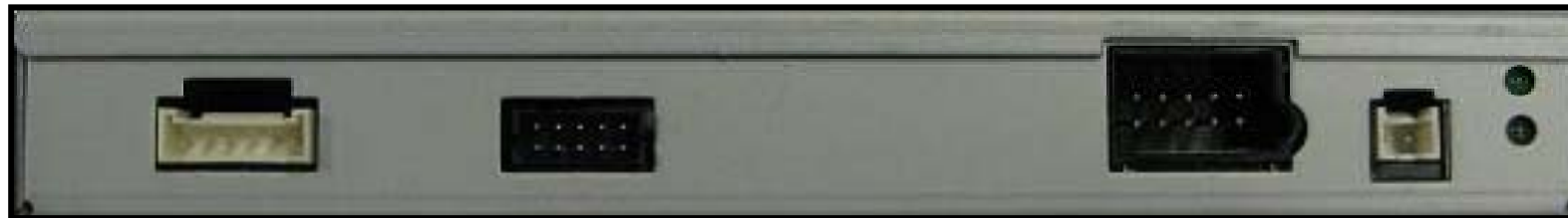

↑
CAN I/F

↑
LCD-OUT

↑
LCD-IN

↑
MODE

↑
LED

※ This can change under manufacturer's circumstance

Connector Pin Assignment

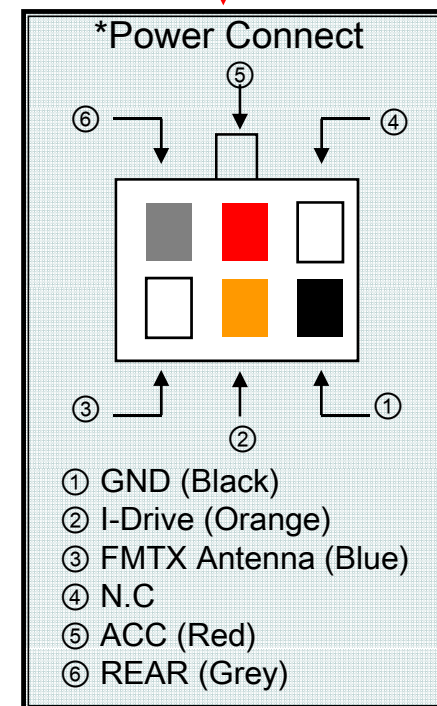
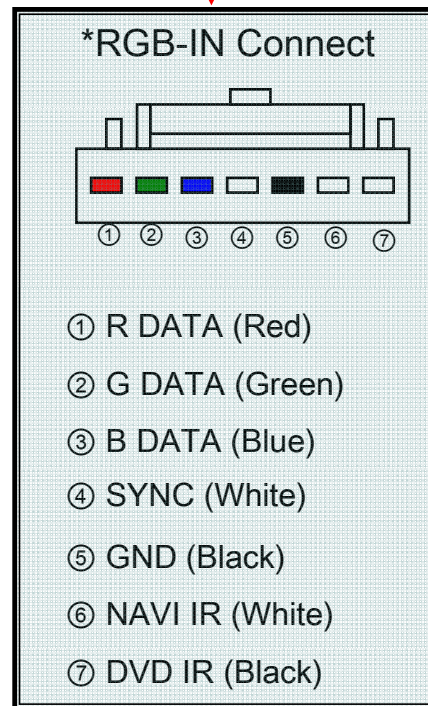
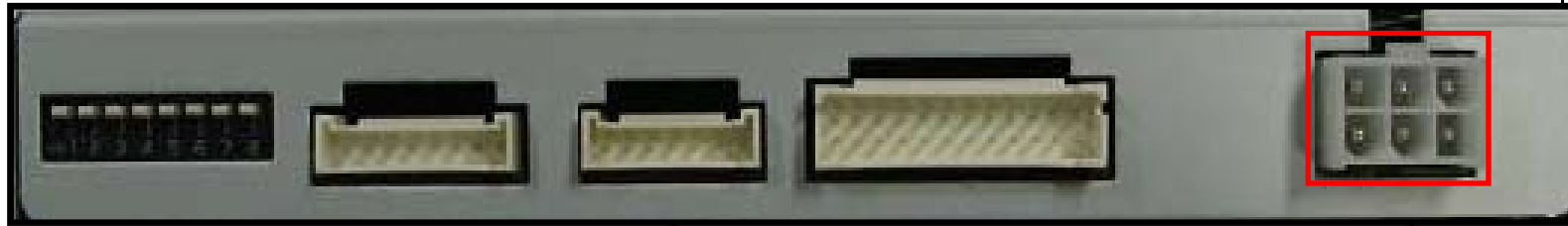

※ This can change under manufacturer's circumstance

Connector Pin Assignment

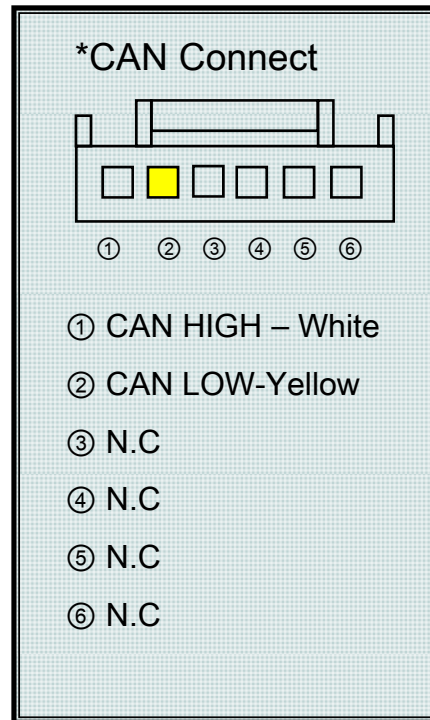
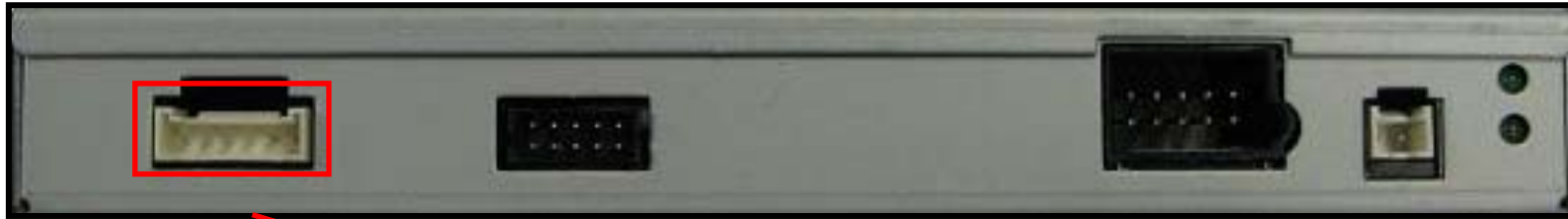

※ This can change under manufacturer's circumstance

Connector Pin Assignment



* Power Cable

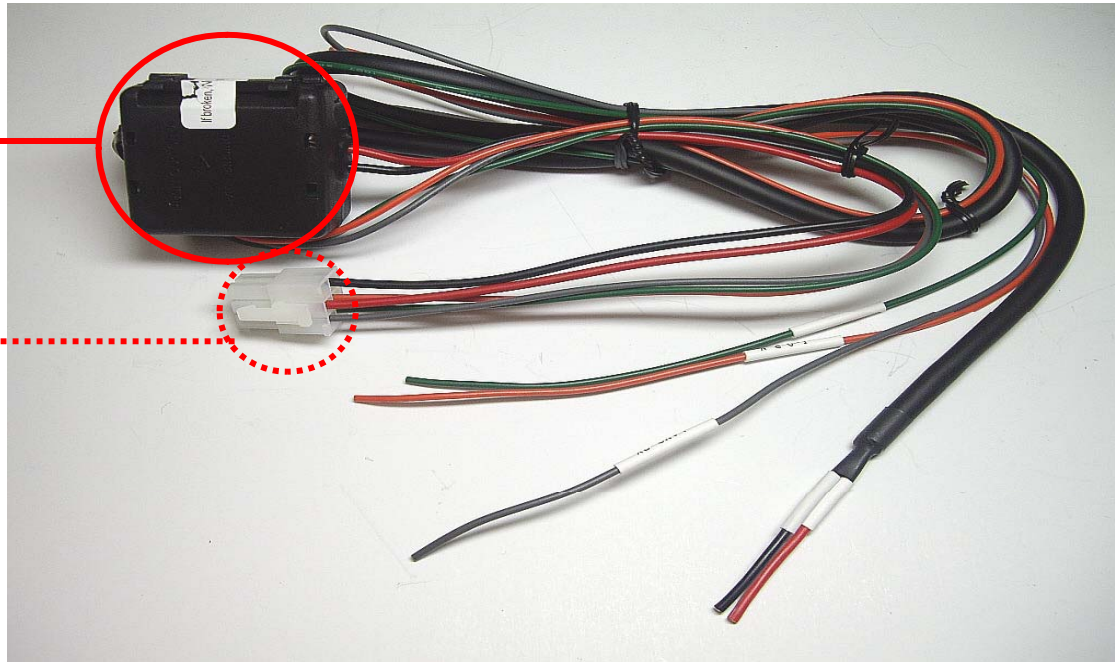

FILTER
& FUSE BOX

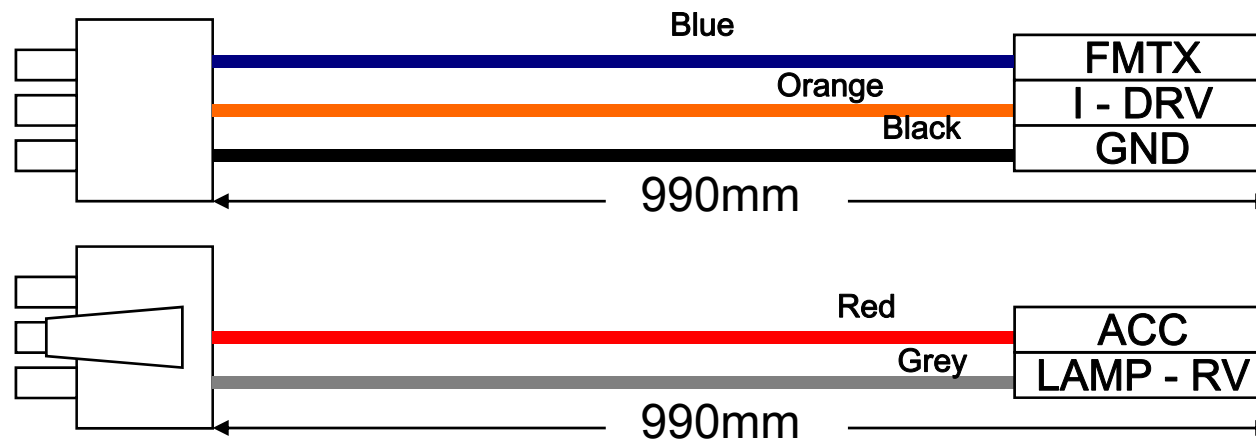
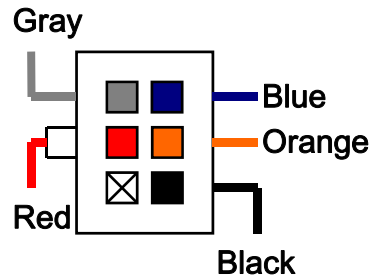

DIP SW



※ ON : DOWN, OFF : UP

#PIN	FUNCTION	DIP S/W Selection
1	RGB INPUT MUTE	ON : Skipping RGB Mode OFF : RGB Display
2	A/V 1 MUTE	ON : Skipping A/V 1 OFF : A/V1 Display
3	A/V 2 MUTE	ON : Skipping A/V 2 OFF : A/V2 Display
4	A/V 3 MUTE	ON : Skipping A/V 3 OFF : A/V3 Display
5	To select monitor size	ON : 6.5" LCD Setting (Possible to use BMW 1 series) OFF : 8.8" LCD Setting
6	Type of monitor (Refer to the next page)	ON : Siemens setting (only when to turn on the 5 th pin) OFF : Alpine setting (only when to turn on the 5 th pin) ON : Operation rear monitor for New 7 (only when to turn off the 5 th pin) OFF : 8.8" Setting
7	Rear Mode	ON : External Rear Camera OFF : OEM Rear Camera
8		N.C

DIP SW



#PIN	5	6
Type of monitor		
E60 8.8"	OFF	OFF
E60 Alpine 6.5"	ON	OFF
E60 Siemens 6.5"	ON	ON
E65 Armrest 6.5"	OFF	ON

※DIP S/W Use Example

[BMW E60-6.5" Alpine]

- Use Input Mode : A/V3(DVD), Navigation (RGB)
- Rear Camera : When to be installed on CVBS 4

- ▷ DIP S/W : 1 → OFF
- ▷ DIP S/W : 2,3 → ON
(INPUT MODE SKIP)
- ▷ DIP S/W : 4 → OFF (enable A/V3)
- ▷ DIP S/W : 5 → ON (6.5" Alpine)
- ▷ DIP S/W : 6 → OFF
- ▷ DIP S/W : 7 → ON (enable CVBS4)
- ▷ DIP S/W : 8 → OFF



[E60 8.8"]



[E60 Alpine 6.5"]



[E60 Siemens 6.5"]



[E65 Armrest 6.5"]

How to use OSD Keypad



MENU : OSD MENU, Going back to the last step of setting after mode setting

SEL : Select, Mode change

UP : Move to Left, Up

DOWN : Move to Right, Down

***FACTORY MODE** : Operated with pressing UP->DOWN->UP->MENU keys of the keypad sequently.

OSD(On Screen Display)



· Analog RGB Mode

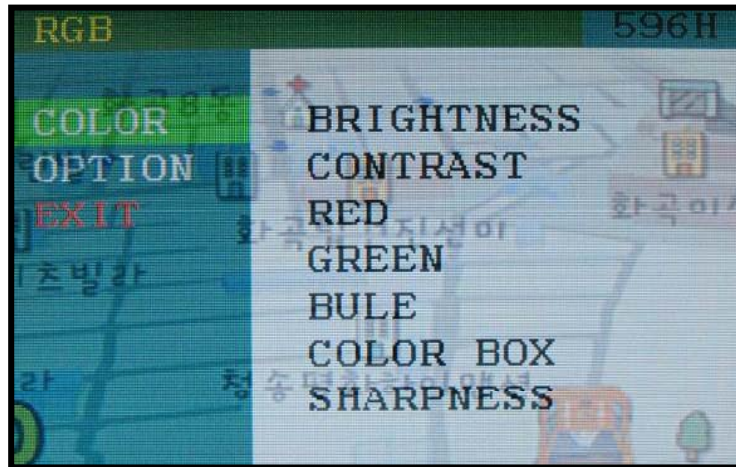

· Video Mode



COLOR Menu

- BRIGHTNESS
- CONTRAST
- RED, GREEN, BLUE
- HUE
- COLOR BOX
- SATURATION
- SHARPNESS

OSD(On Screen Display)



- Analog RGB Mode

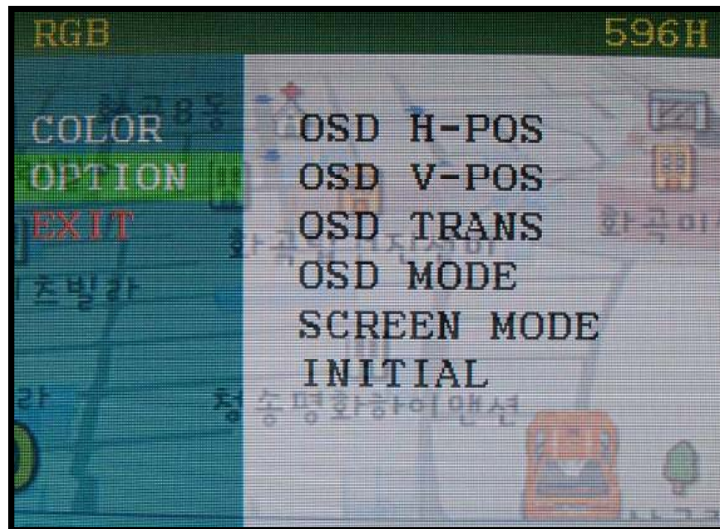

- Video Mode

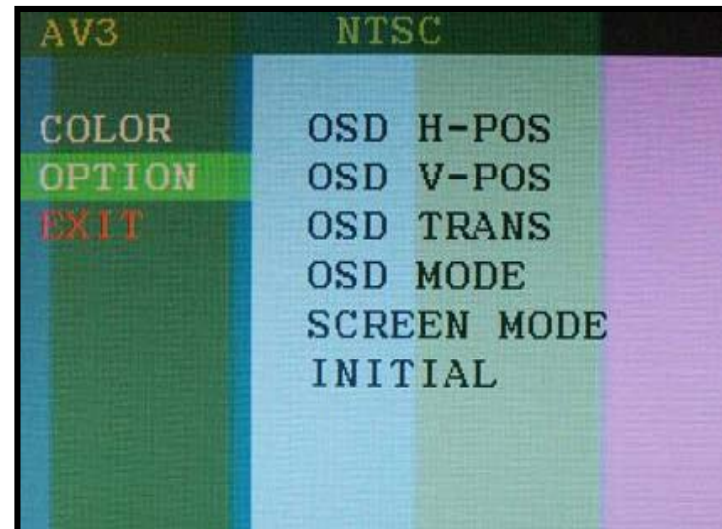

OPTION Menu

- OSD H_POS : Move of OSD window to Left, Right
- OSD V_POS : : Move of OSD window to Up, Down
- OSD TRANS : OSD window transparency setting
- SCREEN MODE : Screen Rate setting (4:3, 16:9)
- INITIAL : Initializing OSD setting value

OSD(On Screen Display)



- **Factory Mode(INTERFACE SETTING)**

-Operated with pressing UP->DOWN->UP->MENU keys of the keypad sequently.

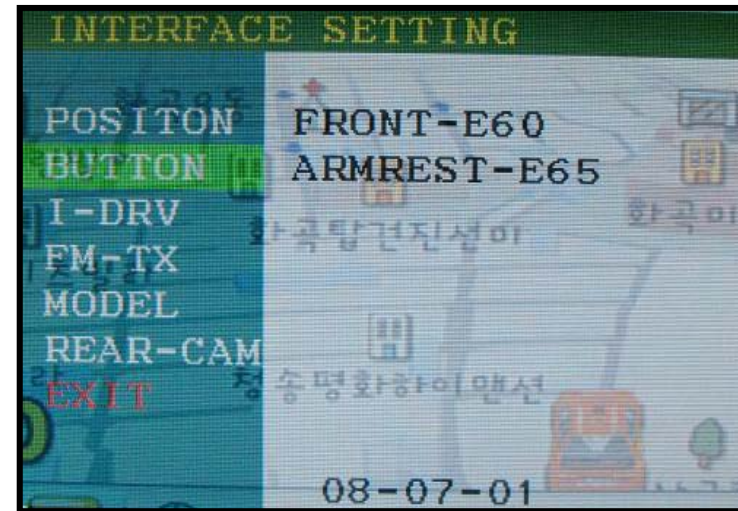
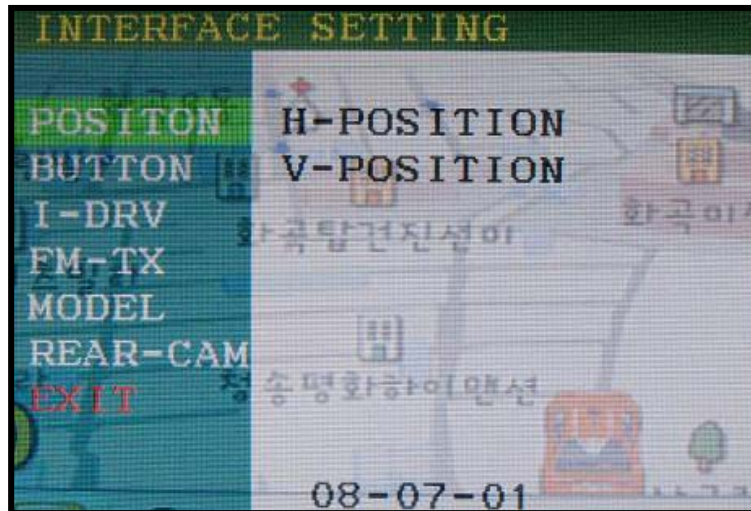

Factory Mode (Interface setting)

- POSITION - H-POSITION : Move of Screen to Left, Right (Only for RGB mode)
 - V-POSITION : Move of Screen to Up, Right (Only for RGB mode)
- FMTX : Refer to the FMTX page

OSD(On Screen Display)



- Factory Mode (INTERFACE SETTING)



Factory Mode (Interface setting)

- I-DRV - To control DVD, Navi by I-DRV (Optional)
- FM-TX - FM-TX USE : FMTX Setting
 - FREQUENCY : FMTX Frequency Setting (Refer to the next 'FMTX frequency setting' page)

OSD(On Screen Display)



- Factory Mode (INTERFACE SETTING)

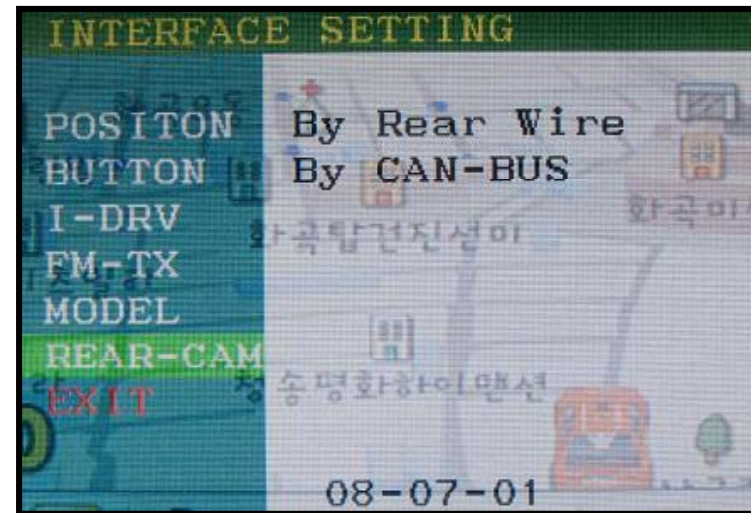
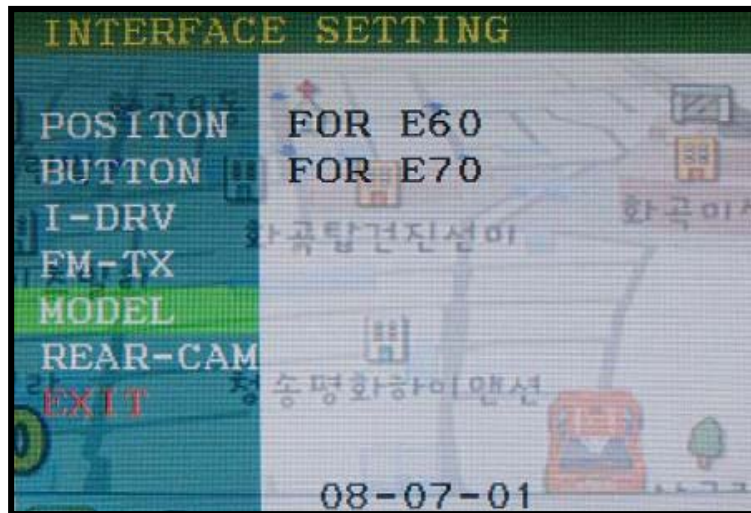

Factory Mode (Interface setting)

- MODEL - For E60 : When to install on E60 (This is initially set)
 - For E70 : When to install on E70 (Not available at present)
- REAR-CAM - By Rear Wire : When to install Back-up Cam by rear wire of power cable (Same with previous version)
 - By CAN-BUS : When to install Back-up Cam by CAN wiring. In this case, when the car is in reverse, the CAM is detected automatically.

FMTX Frequency Setting



Factory Default : FMTX USE – ON, FREQUENCY – 87.5MHz

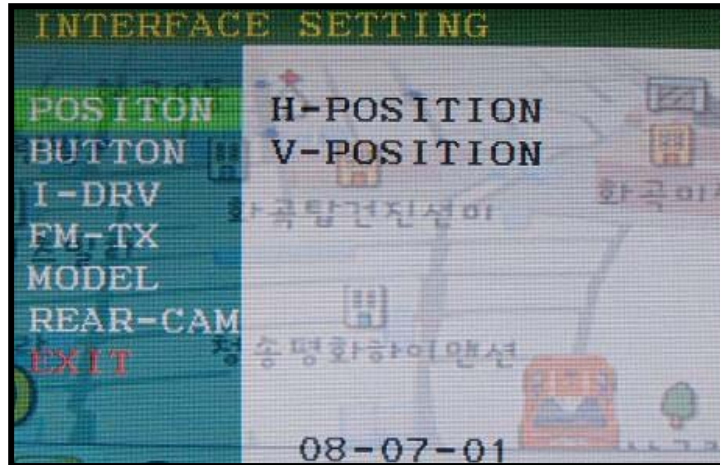

Get the Factory Mode Operated with pressing UP->DOWN->UP->MENU keys of the keypad sequentially

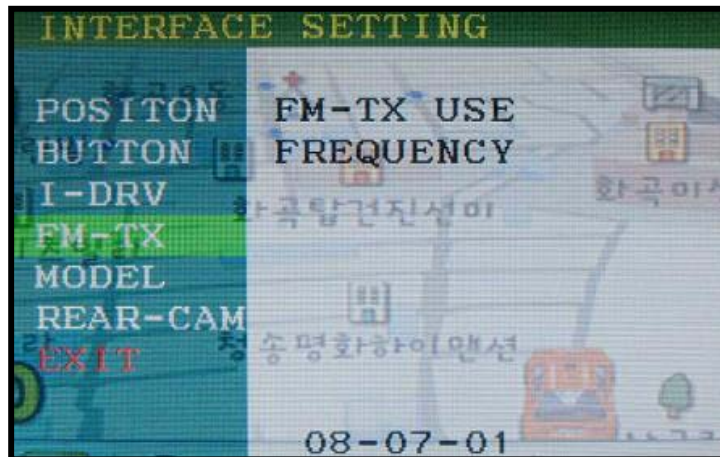

Set “FM-TX USE” to “ON” like the left picture. (‘ON’ is Default). control the frequency by “UP”, “Down” keys. At the bottom, you can see present frequency and control it from 87.5MHz to 108MHz. (1MHz per each time to press)

※If you do not want this function, should set “FM-TX USE” to “OFF”

How to use parking guide line



Factory Default : DISPLAY - DISABLE

①

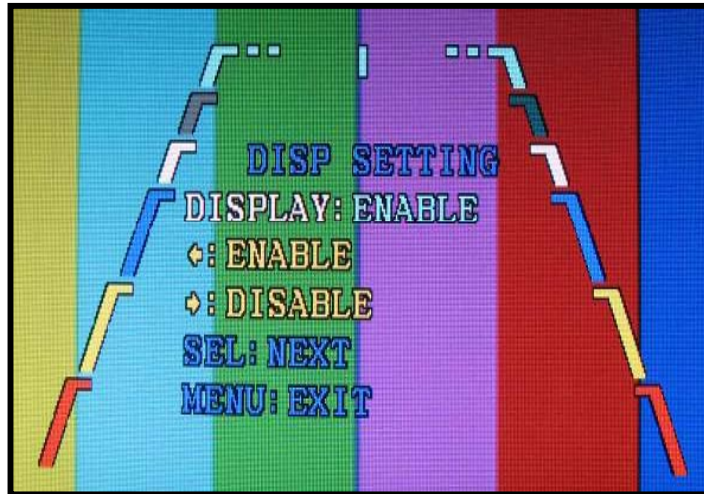

① When the car is in reverse, if press 'UP' key for 2 sec, the guide line appears on the screen.

②

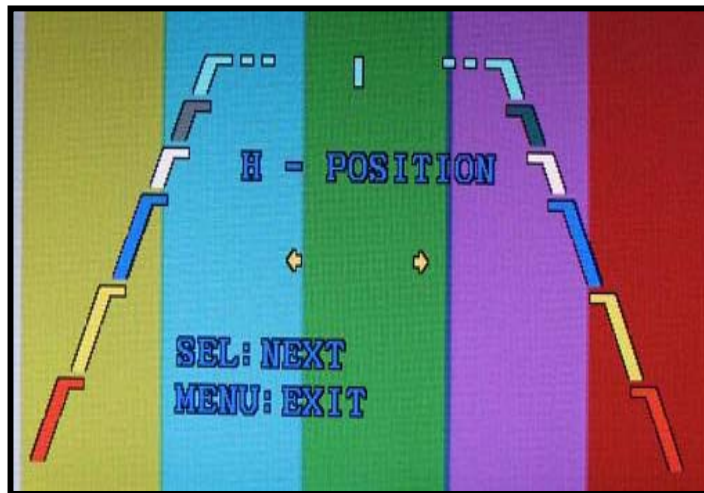

② If you need to move the line position, press 'SEL' key on the above step.
(Use 'Up', 'Down' Key of Keypad)

How to use parking guide line



③

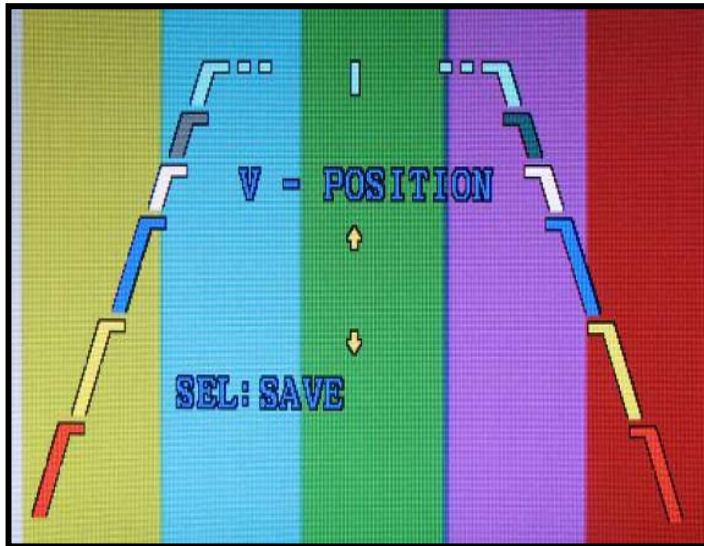

③ On step no.2, once press “SEL” key again, you can move the line vertically by “UP”, “Down” keys.

CAN Wiring

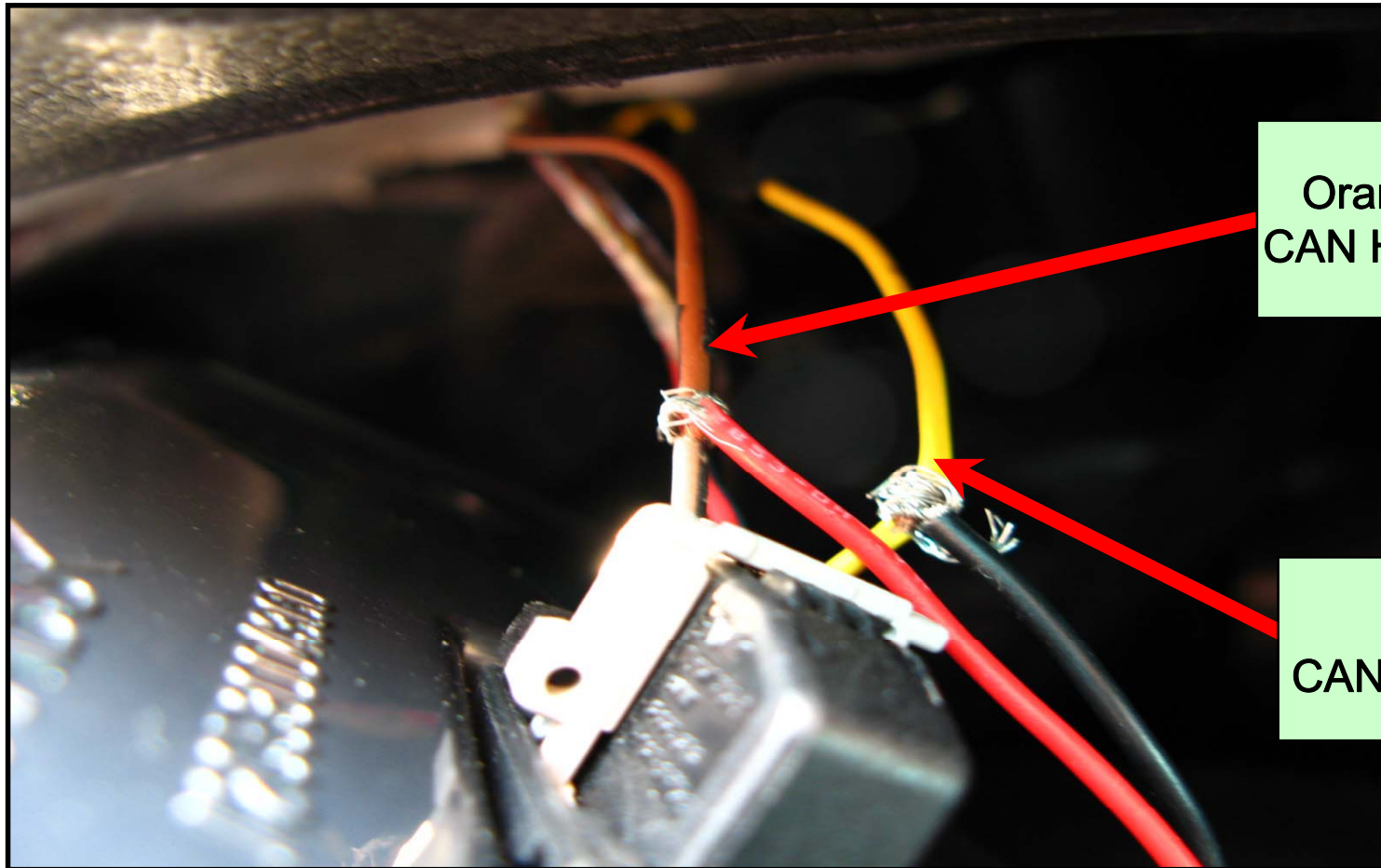

Orange+Black:
CAN HIGH (White)

Yellow:
CAN LOW (Black)

* The color of CAN wires coming from the car can be different by each countries that the car import or any other circumstances.

FAQ



1. When can not change mode.

- Check if the Ground Cable (OSD Keypad) is connected or not.
- Check if LED is turned on or not. If it is not turned on, Check if power cable is connected or not.
- Check if CAN is connected well.

2. When the screen is displaying only black color.

- Check if 2nd LED is turned on or not. If it is not turned on, please check all video sources that you will connect with the interface is operating well or not.
- Check if interface is connected well.

3. When displayed color of screen is not proper. (If it's too dark or the color is not proper)

- Try to push "Reset button" on the remote control. If the color of screen keeps on displaying wrong color, you have to ask manufacturer for the problem.
- Try to adjust Color, Contrast, Brightness by the remote.

4. When Back-up camera is not displayed on the screen.

- Turn Dip S/W no.7 on.

5. When the mode you set is not skip.

- Check if Dip S/W is set in proper way.

6. When Main screen on the car is not displayed.

- Check if In/Out cables are connected well. If it keeps showing the same problem, you have to ask manufacturer for the problem.

7. When the screen is displaying only white color.

- Check if out cable is connected well. If it keeps showing the same problem, you have to ask manufacturer for the problem.